

EUROPE'S LARGEST SELECTION OF TEST & MEASUREMENT EQUIPMENT FOR HIRE

INLEC.COM

DATA-SHEET



Nationwide Low Call
0333 6000 600

WHY BUY
WHEN YOU CAN HIRE

FLUKE®

714

Thermocouple Calibrator

Instruction Sheet

Introduction

The Fluke 714 Thermocouple Calibrator is a precise source and measurement tool for calibrating thermocouple instruments. The calibrator sources or measures in units of °C, °F, or mV, through a thermocouple minijack.

Your calibrator is supplied with a Flex-Stand™ holster, an installed 9 V alkaline battery, and this instruction sheet. Sets of thermocouple miniplugs are available from Fluke. (Accessories Fluke-700TC1 and Fluke-700TC2 TC Miniplug Kits.)

If the calibrator is damaged or something is missing, contact the place of purchase immediately. Contact your Fluke distributor for information about accessories. To order replacement parts or spares, see "Replacement Parts."

The following tables list the thermocouple types supported by the calibrator, the standards and scales used for each type, the thermocouple properties, and calibrator resolution. Full calibrator specifications are listed at the end of this instruction sheet.

Note

Since mV input and output units are available, you can use the calibrator for any thermocouple type by making manual calculations or referring to tables.

Thermocouple Standards and Scales

Thermocouple Type	Standard	Scale
J, K, T, E, R, S, B	NIST 175	ITS-90
L (J-DIN), U (T-DIN)	DIN 43710	IPTS-68

Thermocouple Properties

Thermocouple Type	Temperature Ranges	Display Resolution
J	-200 to 1200°C, -328 to 2192°F	0.1°C or °F
K	-200 to 1370°C -328 to 2498°F	0.1°C or °F
T	-200 to 400°C -328 to 752°F	0.1°C or °F
E	-200 to 950°C -328 to 1742°F	0.1°C or °F
R	-20 to 1750°C -4 to 3182°F	1°C or °F
S	-20 to 1750°C -4 to 3182°F	1°C or °F
B	600 to 1800°C 1112 to 3272°F	1°C or °F
L	-200 to 900°C -328 to 1652°F	0.1°C or °F
U	-200 to 600°C -328 to 1112°F	0.1°C or °F







Millivolt Range and Resolution

Mode	Range	Display Resolution
mV	-10 to 75 mV	0.01 mV

Explanation of International Symbols

The following symbols are used on the calibrator or in this instruction sheet. The table below explains their meaning.

International Symbols

Symbol	Meaning
	Earth ground
	Fuse
	Battery
	Refer to this instruction sheet for information about this feature.
	Double insulated
	Conforms to relevant Canadian Standards Association directives.
	Conforms to European Union directives

Safety Information

⚠ Warning

To avoid possible electric shock or personal injury:

- **Never apply more than 30 V between the TC terminals, or between either TC terminal and earth ground.**
- **Make sure the battery door is closed and latched before you operate the calibrator.**
- **Remove an attached thermocouple miniplug from the calibrator before you open the battery door.**
- **Do not operate the calibrator if it is damaged.**
- **Do not operate the calibrator around explosive gas, vapor, or dust.**

When servicing the calibrator, use only specified replacement parts.

Turning the Calibrator On

Press the green © pushbutton to turn the calibrator on and off.

Measuring a Thermocouple

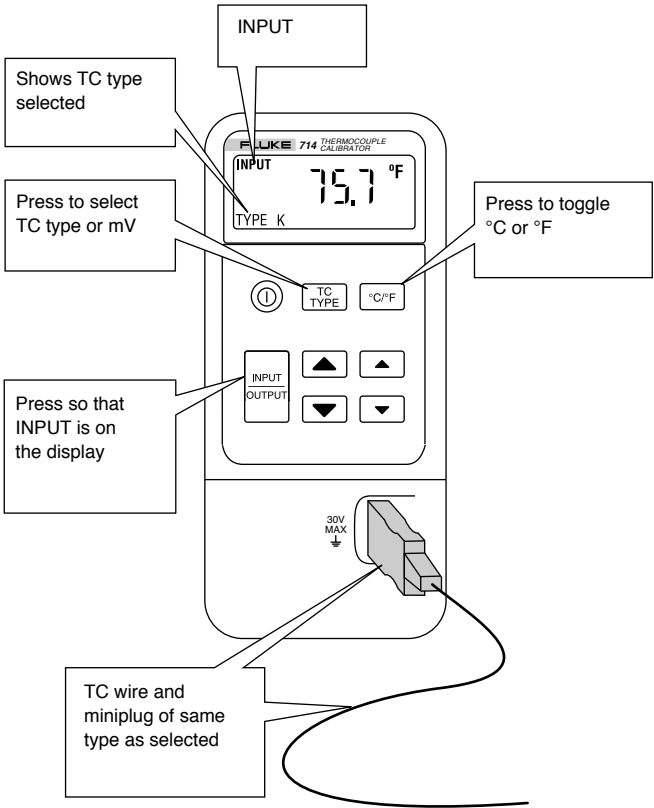

Simulating a Thermocouple

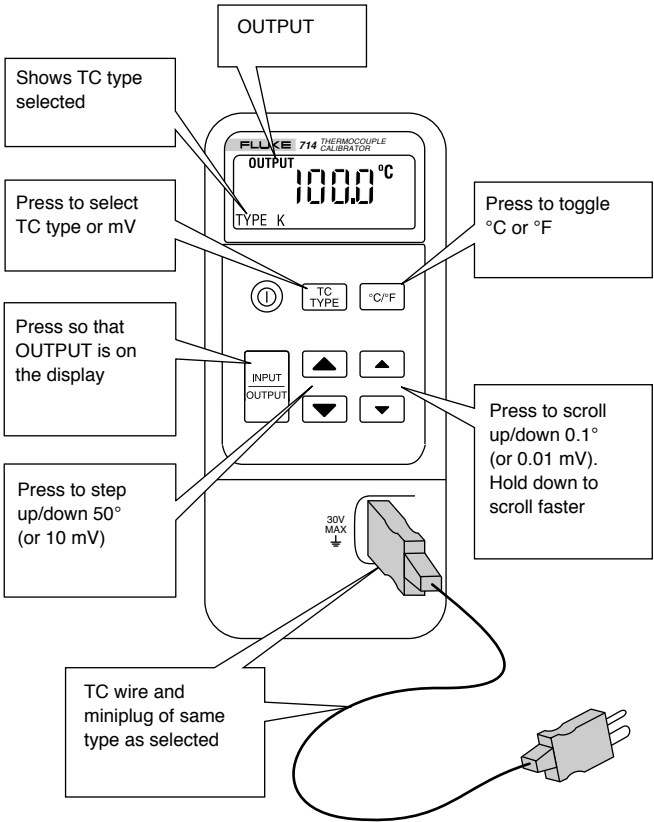

Maintenance

For maintenance procedures not described in this sheet, contact a Fluke Service Center.

In Case of Difficulty

- Check the battery and thermocouple test wiring. Replace as necessary.
- Review this sheet to make sure you are using the calibrator correctly.

If the calibrator needs repair, contact a Fluke Service Center. If the calibrator is under warranty, see the warranty statement for terms. If the warranty has lapsed, the calibrator will be repaired and returned for a fixed fee. Contact a Fluke Service Center for information and price.

Cleaning

Periodically wipe the case with a damp cloth and detergent; do not use abrasives or solvents.

Calibration

Calibrate your calibrator once a year to ensure that it performs according to its specifications. A calibration manual is available (PN 686540). Call 1-800-526-4731 from the USA and Canada. In other countries, contact a Fluke Service Center.

Replacing the Battery

When the  symbol appears on the display, replace the battery with a 9 V alkaline battery.

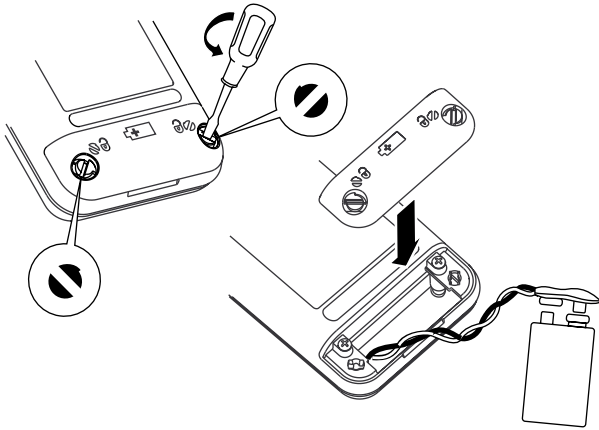

it07f.eps

Replacing the Fuse

⚠ Warning

To avoid personal injury or damage to the calibrator, use only a 0.125A 250V fast fuse, Littelfuse® 2AG.

Fuse F1 is probably blown if in the input mode, the calibrator always reads OL, even with a thermocouple connected.

Replace the fuse as follows:

1. Remove the test leads and turn the calibrator off.
2. Remove the battery door.
3. Remove the three Phillips-head screws from the case bottom and turn the case over.
4. Gently lift the top cover from the end nearest the input/output terminals until it unsnaps from the bottom cover.
5. Replace the fuse with a 0.125 A 250 V fast fuse, Littelfuse® 2AG.
6. Fit the top and bottom covers together, engaging the two snaps. Make sure that the gasket is properly seated. Reinstall the three screws.
7. Replace the battery door.

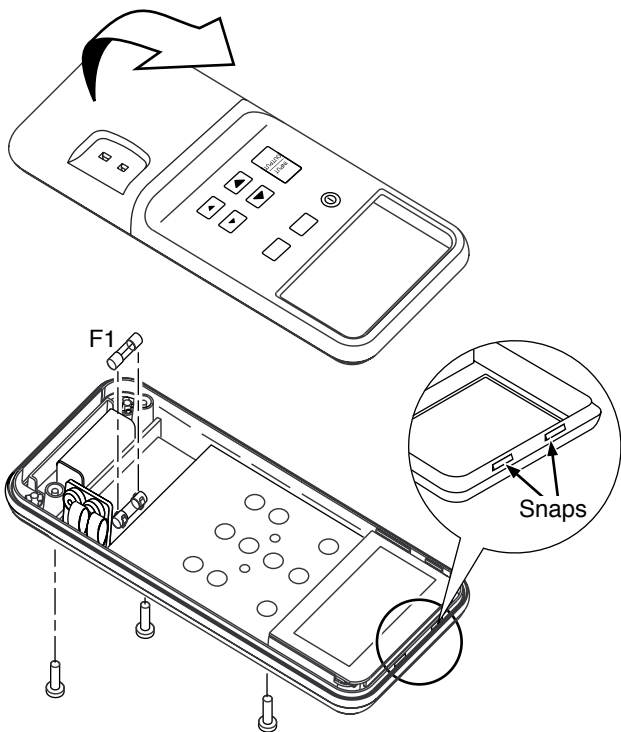

Replacement Parts and Accessories

Replacement Parts

Item	Description	PN or Model no.	Qty.
BT1	9V battery, ANSI/NEDA 1604A or IEC 6LR61	614487	1
CG81Y	Holster, Yellow	CG81Y	1
 F1	Fuse, 125 mA, 250V fast	686527	1
MP85	Case top	620234	1
MP86	Case bottom	620168	1
H2, 3, 4	Case screw	832246	3
MP89, 90	Non-skid foot	824466	2
MP92	Battery door	619947	1
H5, 6	Battery door fasteners	948609	2
S1	Keypad	687076	1
-	714 Instruction Sheet	560306	1
-	71X Series Calibration Manual	686540	Option

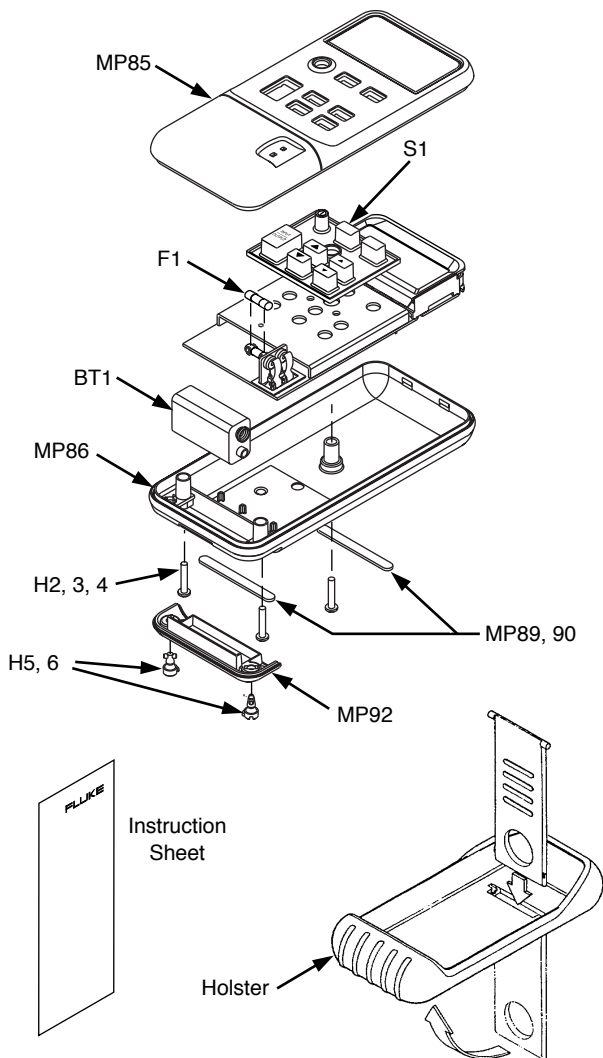

Specifications

Specifications are based on a one year calibration cycle and apply for ambient temperature from +18°C to +28°C unless stated otherwise. “Counts” means number of increments or decrements of the least significant digit.

Temperature Measure and Thermocouple Simulate

TC Type	Resolution	Error	Reference Junction Error
J, K, T, E, L, U	0.1°C or °F	$\pm(0.3^{\circ}\text{C} + 10 \mu\text{V})$	$\pm 0.2^{\circ}\text{C}$
B, R, S	1°C or °F	$\pm(0.3^{\circ}\text{C} + 10 \mu\text{V})$	$\pm 0.2^{\circ}\text{C}$

Maximum input voltage: 30 V

Millivolt Measure and Source

Range	Resolution	Accuracy
-10 mV to 75 mV	0.01 mV	$\pm(0.025\% + 1 \text{ count})$

Maximum input voltage: 30 V

General Specifications

Maximum voltage applied between any terminal and earth ground or between any two terminals: 30 V

Storage temperature: -40°C to 60°C

Operating temperature: -10°C to 55°C

Operating altitude: 3000 meters maximum

Temperature coefficient: 0.05 x specified accuracy per °C for temperature ranges -10°C to 18°C and 28°C to 55°C

Relative humidity: 95% up to 30°C, 75% up to 40°C, 45% up to 50°C, and 35% up to 55°C

Vibration: Random 2 g, 5 Hz to 500 Hz

Shock: 1 meter drop test

Safety: Certified as compliant to CAN/CSA C22.2 No. 1010.1:1992. Complies with ANSI/ISA S82.01-1994.

Power requirements: Single 9 V battery (ANSI/NEDA 1604A or IEC 6LR61)

Size: 32 mm H x 87 mm W x 187 mm L (1.25 in H x 3.41 in W x 7.35 in L);

With holster and Flex-Stand: 52 mm H x 98 mm W x 201 mm L (2.06 in H x 3.86 in W x 7.93 in L)

Weight: 332 g (11.7 oz);

With holster and Flex-Stand: 584 g (20.6 oz)

How to Contact Fluke

To order accessories, receive operating assistance, or get the location of the nearest Fluke distributor or Service Center, call:

1-800-44FLUKE (1-800-443-5853) in U.S.A. and Canada

+31-402-678-200 in Europe

+1-425-356-5500 from other countries

Address correspondence to:

Fluke Corporation
P.O. Box 9090,
Everett, WA 98206-9090
U.S.A.

Fluke Europe B.V.
P.O. Box 1186,
5602 BD Eindhoven
The Netherlands

Visit us on the World Wide Web at: **www.fluke.com**

LIMITED WARRANTY & LIMITATION OF LIABILITY

This Fluke product will be free from defects in material and workmanship for three years from the date of purchase. This warranty does not cover fuses, disposable batteries or damage from accident, neglect, misuse or abnormal conditions of operation or handling. Resellers are not authorized to extend any other warranty on Fluke's behalf. To obtain service during the warranty period, send your defective calibrator to the nearest Fluke Authorized Service Center with a description of the problem.

THIS WARRANTY IS YOUR ONLY REMEDY. NO OTHER WARRANTIES, SUCH AS FITNESS FOR A PARTICULAR PURPOSE, ARE EXPRESSED OR IMPLIED. FLUKE IS NOT LIABLE FOR ANY SPECIAL, INDIRECT, INCIDENTAL OR CONSEQUENTIAL DAMAGES OR LOSSES, ARISING FROM ANY CAUSE OR THEORY. Since some states or countries do not allow the exclusion or limitation of an implied warranty or of incidental or consequential damages, this limitation of liability may not apply to you.

INLEC, supporting you to deliver a world class service, every day, in every sector ...



OUR COMMITMENT TO YOU

A wealth of knowledge and experience.

You can take advantage of expert advice to ensure you get the best, most appropriate and cost effective equipment for the job. We supply a wide variety of industries, so if there is another way to do the job or save you time and money we'll pass on the benefit of our experience for free.

Honest advice, just a phone call away.

If we don't have a particular item, rather than hiring you something that won't do the job, we would rather direct you to an alternative supplier. You will always be provided with full instructions and if you still need help, call our technical team on Nationwide Low Call 0333 6000 600. Our aim is to save you time, frustration and money.

Top quality equipment from major manufacturers.

With Inlec you'll get the most accurate, reliable and well-maintained equipment available. Prices are regularly reviewed to ensure you always enjoy the best value for money. We have made a significant investment in test equipment so we ensure that it's well packed to minimise damage and delay.

We really do listen to you.

You won't waste your time contacting Inlec. Every request for equipment is logged and carefully considered. Listening to our customers helps keep our product range up to date and relevant. If you are unhappy about any aspect of our service please let us know so we can put it right.

YOUR 5 WAY GUARANTEE

1 GUARANTEE SAME DAY DESPATCH

We understand why prompt delivery is important to you. So, if we confirm your order before 3pm, you are guaranteed same day despatch.

2 OUR PRICE GUARANTEE

Inlec guarantee you real value for money. Our price match policy is simple - if you can hire the same product for less elsewhere, we guarantee to match that price and reduce it by a further 10% of the difference - and still deliver our industry leading technical and customer support.

For full details check our price-match guarantee online

3 TOP QUALITY GUARANTEED

All equipment is thoroughly checked prior to dispatch to ensure you receive it in full, safe working order. Your shipment will be securely packed and include manufacturer's instructions, accessories or consumables and a valid calibration certificate where appropriate. In addition, Inlec offer a 24 hour replacement service if you decide the equipment is not suitable for your application*.

4 FRIENDLY, KNOWLEDGEABLE ADVICE GUARANTEED

Inlec are happy to provide you with free advice, from an unbeatable team of experienced, knowledgeable and friendly engineers and hire experts.

5 YOUR GUARANTEE OF THE BEST CUSTOMER SERVICE

Throughout your hire we will work hard to ensure you enjoy the very best in support and service from Inlec. We guarantee you won't find better service anywhere in the industry.

*subject to availability and conditions

Europe's leading Test Equipment Hire Specialist



LAB NO. 0535



Nationwide Low Call 0333 6000 600

Online: www.inlec.com

Inlec UK Ellerbeck Way, Stokesley Business Park, Stokesley N Yorkshire TS9 5JZ United Kingdom



CERT. NO. GB93/1773



Accredited Contractor