

EUROPE'S LARGEST SELECTION OF TEST & MEASUREMENT EQUIPMENT FOR HIRE

**INLEC.COM**

# DATA-SHEET



Nationwide Low Call  
**0333 6000 600**

**WHY BUY**  
WHEN YOU CAN HIRE

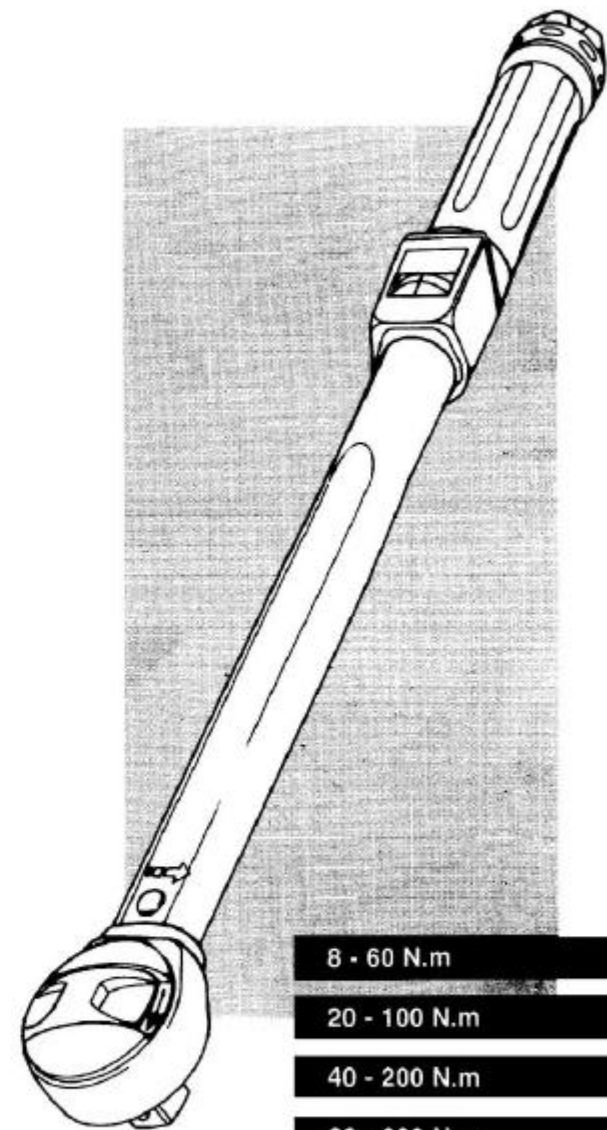
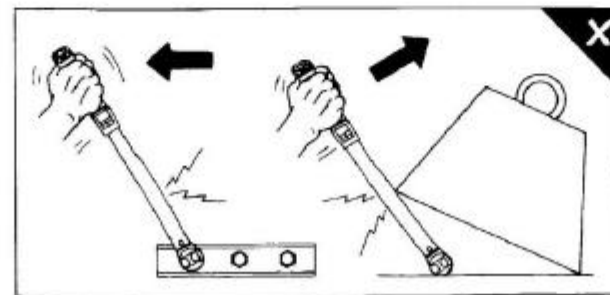
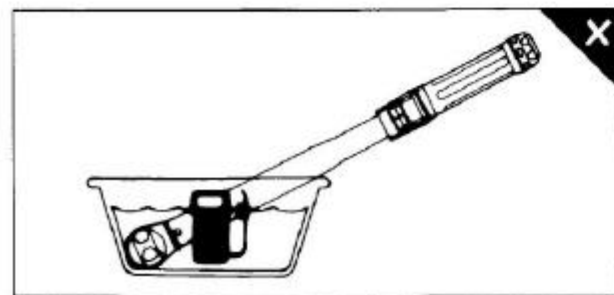
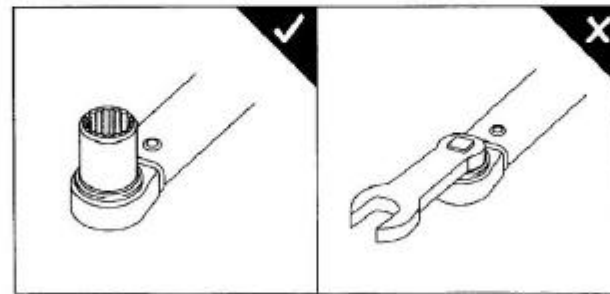
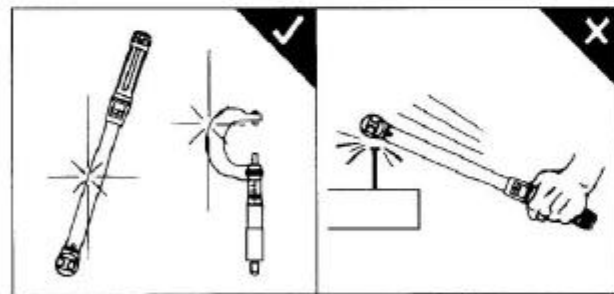
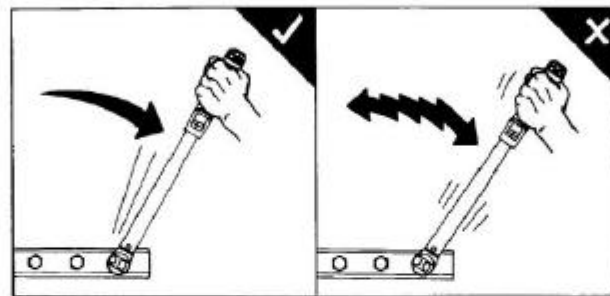
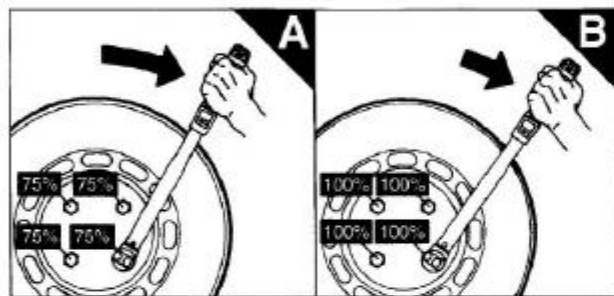
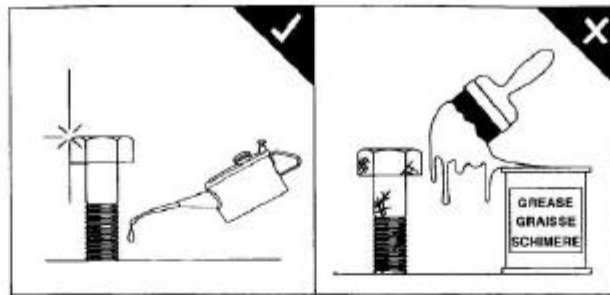
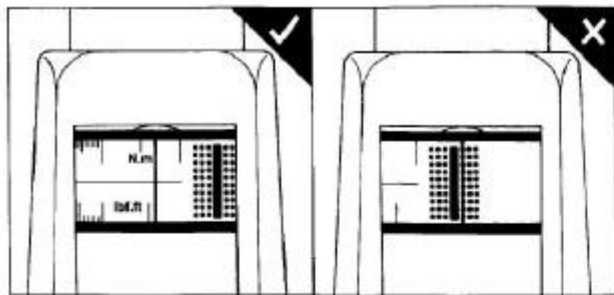

- 8 - 60 N.m
- 20 - 100 N.m
- 40 - 200 N.m
- 60 - 300 N.m
- 60 - 330 N.m

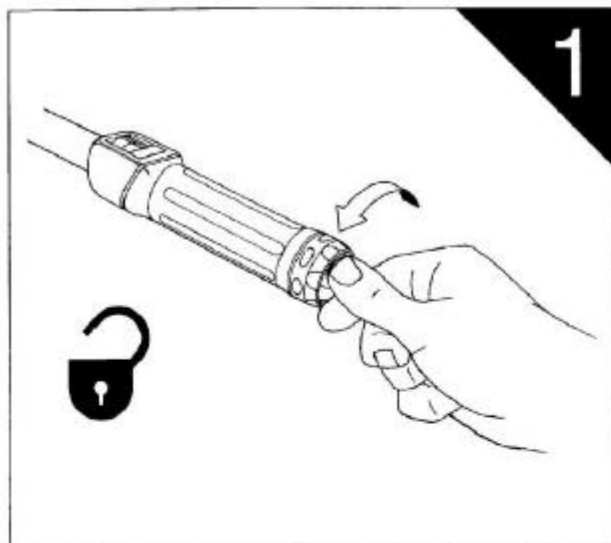

Unlock • Déverrouiller la molette • Entsichern  
Sbloccare • Desbloquear

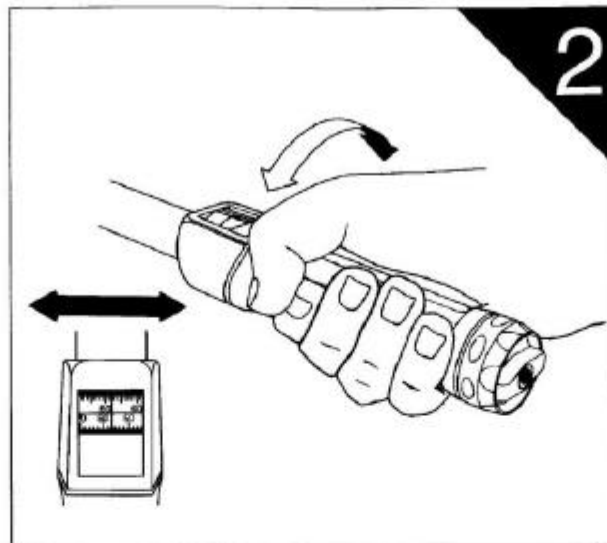

Adjust • Régler • Einstellen  
Regolare • Ajustar

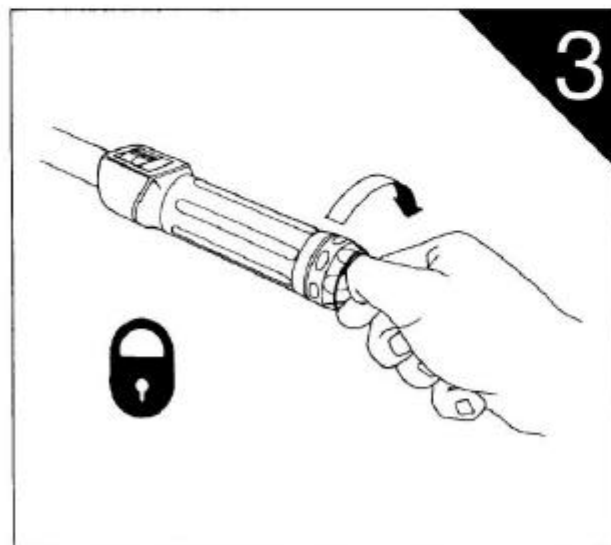

Lock • Verrouiller la molette • Sichern  
Bloccare • Bloquear

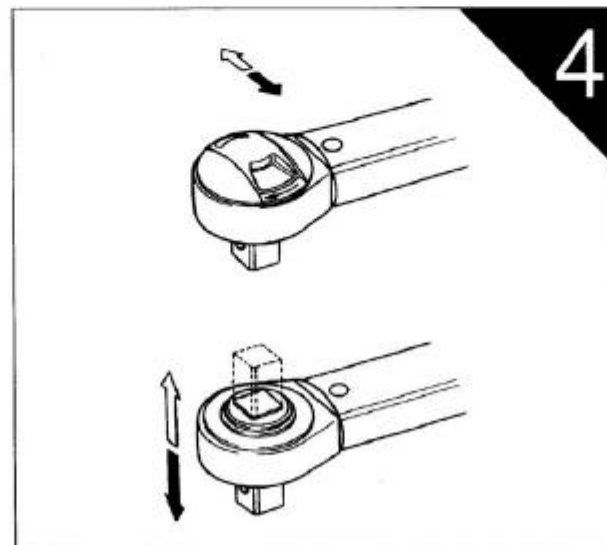

Set ratchet direction • Régler la direction de serrage • Wahl der  
Arbeitsrichtung • Fissare direzione cricchetto • Seleccionar

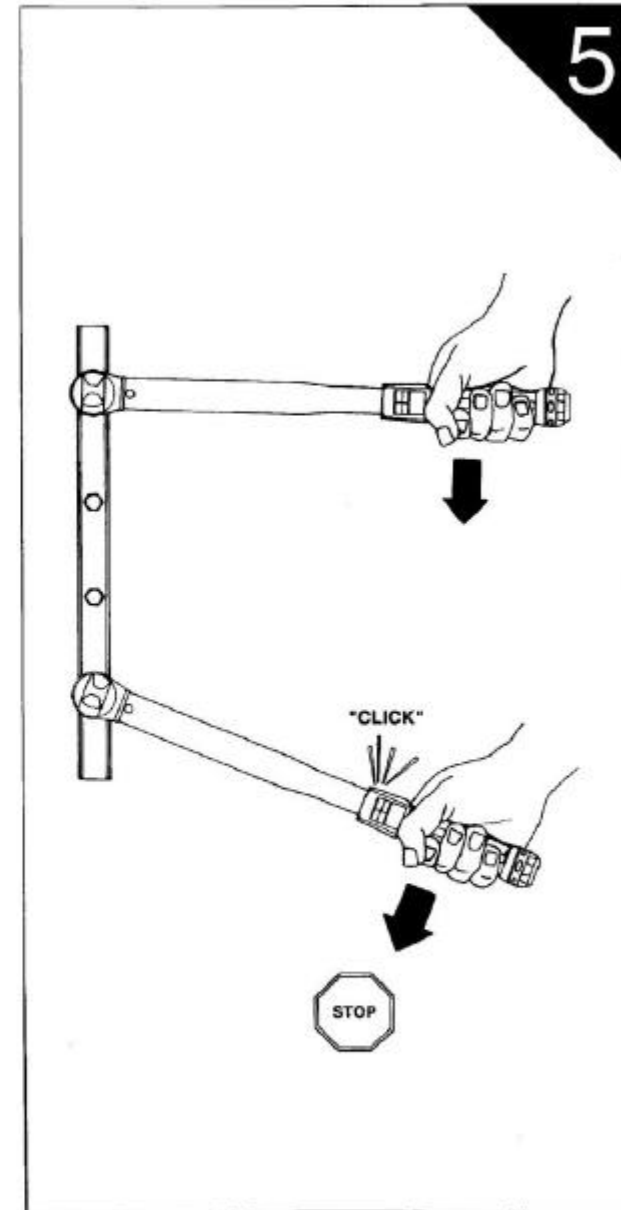

Apply Torque • Appliquer le couple • Drehmoment Anwendung  
Applicare la coppia • Aplicar el par de apriete

# INLEC, supporting you to deliver a world class service, every day, in every sector ...



## OUR COMMITMENT TO YOU

### A wealth of knowledge and experience.

You can take advantage of expert advice to ensure you get the best, most appropriate and cost effective equipment for the job. We supply a wide variety of industries, so if there is another way to do the job or save you time and money we'll pass on the benefit of our experience for free.

### Honest advice, just a phone call away.

If we don't have a particular item, rather than hiring you something that won't do the job, we would rather direct you to an alternative supplier. You will always be provided with full instructions and if you still need help, call our technical team on Nationwide Low Call 0333 6000 600. Our aim is to save you time, frustration and money.

### Top quality equipment from major manufacturers.

With Inlec you'll get the most accurate, reliable and well-maintained equipment available. Prices are regularly reviewed to ensure you always enjoy the best value for money. We have made a significant investment in test equipment so we ensure that it's well packed to minimise damage and delay.

### We really do listen to you.

You won't waste your time contacting Inlec. Every request for equipment is logged and carefully considered. Listening to our customers helps keep our product range up to date and relevant. If you are unhappy about any aspect of our service please let us know so we can put it right.

## YOUR 5 WAY GUARANTEE

### 1 GUARANTEE SAME DAY DESPATCH

We understand why prompt delivery is important to you. So, if we confirm your order before 3pm, you are guaranteed same day despatch.

### 2 OUR PRICE GUARANTEE

Inlec guarantee you real value for money. Our price match policy is simple - if you can hire the same product for less elsewhere, we guarantee to match that price and reduce it by a further 10% of the difference - and still deliver our industry leading technical and customer support.

For full details check our price-match guarantee online

### 3 TOP QUALITY GUARANTEED

All equipment is thoroughly checked prior to dispatch to ensure you receive it in full, safe working order. Your shipment will be securely packed and include manufacturer's instructions, accessories or consumables and a valid calibration certificate where appropriate. In addition, Inlec offer a 24 hour replacement service if you decide the equipment is not suitable for your application\*.

### 4 FRIENDLY, KNOWLEDGEABLE ADVICE GUARANTEED

Inlec are happy to provide you with free advice, from an unbeatable team of experienced, knowledgeable and friendly engineers and hire experts.

### 5 YOUR GUARANTEE OF THE BEST CUSTOMER SERVICE

Throughout your hire we will work hard to ensure you enjoy the very best in support and service from Inlec. We guarantee you won't find better service anywhere in the industry.

\*subject to availability and conditions

## Europe's leading Test Equipment Hire Specialist



LAB NO. 0535



Nationwide Low Call 0333 6000 600

Online: [www.inlec.com](http://www.inlec.com)

Inlec UK Ellerbeck Way, Stokesley Business Park, Stokesley N Yorkshire TS9 5JZ United Kingdom



CERT. NO. GB93/1773



Accredited Contractor