

M

DET Series



EARTH GROUND ELECTRODE TESTERS

USER GUIDE

CONTENTS

CONTENTS	2
INTRODUCTION	3
G SAFETY WARNINGS	4
G LIVE EARTH SAFETY PRECAUTIONS	5
G BATTERY INSTALLATION	5
G BATTERY CHARGING (DET4TCR ONLY)	5
GENERAL DESCRIPTION	6
PREPARATIONS FOR USE	9
GENERAL OPERATING INSTRUCTIONS	10
INSTRUMENT ILLUSTRATIONS	12
BATTERY	18
DESCRIPTION OF TESTS	23
PREVENTIVE INSTRUMENT MAINTENANCE	60
TECHNICAL SPECIFICATION	61
REPAIR AND WARRANTY	64

Symbols used on the instrument are:

- G** Caution: refer to accompanying notes
- t** Equipment protected throughout by Double Insulation (Class II)
- C** Equipment complies with current EU directives
-  Equipment complies with “C tick” requirements
-  Do not dispose of in normal waste stream

Note: The safety warnings provided in this document are indicative of safe practice and shall not be considered exhaustive. Additionally, they are not intended to replace local safety procedures where the instrument is being used.

Note: This user guide uses the terms ‘earth’ and ‘ground’ interchangeably.

INTRODUCTION

Thank you for purchasing the Megger Earth Ground Tester.

For your own safety and to get the maximum benefit from your instrument, please ensure that you read and understand the following safety warnings and instructions before attempting to use the instruments.

This user manual describes the operation and functions of the DET series of Earth Ground Testers:

- DET3TA
- DET3TC
- DET3TD
- DET4TD
- DET4TC
- DET4TCR
- ICLAMP
- VCLAMP
- CALIBRATION ADAPTOR
- TWO-CLAMP CALIBRATION ADAPTOR

These instruments are designed and manufactured by:

Megger Limited
Archcliffe Road
Dover
Kent
CT17 9EN
England

Megger Limited reserves the right to change the specification of these instruments at any time without prior notice.

G SAFETY WARNINGS

- **Safety Warnings** and **Precautions must be read** and understood before the instrument is used. They must be observed during use.
- **Do not leave** the instrument connected to the system under test when not in use.
- **Do not touch** circuit connections and exposed metalwork of an installation or equipment under test.
- **Do not touch** the earth stakes, test leads and their terminations (including connections to the earthing system under test) if an installation earth fault can arise unless adequate precautions are taken.
- **Do not touch** the earth stakes, test leads and their terminations (including connections to the earthing system under test) while the instrument is switched on.
- **Do not operate** the instrument or connect it to any external system if it shows any visible signs of damage or if it has been stored for prolonged periods in unfavourable conditions.
- **Do not operate** the instrument or connect it to any external system if the battery compartment or casing is open or any parts of the case (including keypad, selector switch, display window, etc.) are missing.
- **Special precautions** are necessary when operating in situations where "live" earths may be encountered: isolation switches and fuses (not supplied with this instrument) must be used.
- **Special precautions** are necessary when working near high tension systems (MV and HV): rubber gloves and shoes (not supplied with this instrument) should be worn.
- **Special precautions** are necessary when working in wet conditions or in agricultural areas: observe the local safety standards and take all necessary special precautions applicable to the particular location and do not touch the test leads with bare hands.
- **Always disconnect** the instrument from the earthing system under test while batteries are being changed or the fuse replaced.
- **Always replace** batteries and fuses with parts of the correct type and rating.
- **Do not replace** the rechargeable cells in the DET4TCR with non-rechargeable "dry" cells.
- **Do not use** any other charging equipment other than that supplied by Megger for use with the DET4TCR.
- **Do not operate** the charging equipment supplied with the DET4TCR in damp or wet environments or outside.

NOTE: THE INSTRUMENT MUST ONLY BE USED BY SUITABLY TRAINED AND COMPETENT PERSONS.

Users of this equipment and/or their employers are reminded that National Health and Safety Legislation requires them to carry out valid risk assessments of all electrical work so as to identify potential sources of electrical danger and risk of electrical injury such as inadvertent short circuits. Where the assessments show that the risk is significant then the use of fused test leads may be appropriate.

G LIVE EARTH SAFETY PRECAUTIONS

A 'Live' earth is one that carries current from the mains supply, or could do so under fault conditions. The following warnings apply in addition to those listed previously.

- All persons involved must be trained and competent in isolation and safety procedures for the system to be worked on. They must be clearly instructed not to touch the earth electrode, test stakes, test leads, or their terminations if any 'Live' earths may be encountered. It is recommended that they wear appropriate rubber gloves, rubber soled shoes, and stand on a rubber mat.
- The earth electrode under test should be isolated from the circuit it is protecting before testing commences. If this is not possible, ART may be used to measure electrode resistance.
- The instrument terminals should be connected to the system under test through isolation switches that are rated to handle the likely maximum fault voltages and currents that could be encountered at the installation. The isolation switch must be open whilst any personal contact is made with the remote test stakes, or the connecting leads, e.g. when changing their position.
- The instrument terminals should be connected to the system under test through fuses that are rated to handle the likely maximum fault voltages and currents that could be encountered at the installation.

G BATTERY INSTALLATION

Warning: Whenever battery cells are being fitted or replaced, there should be no connections to the instrument terminals and the instrument should be switched off.

Warning: To avoid damage by leaking electrolyte or deep discharge, do not leave cells fitted in an instrument which will remain unused for extended periods of time.

Warning: Incorrect battery cell polarity can cause electrolyte leakage, resulting in damage to the instrument. If the battery condition indicator does not show a full charge when battery cells are new, a cell may be reversed.

DET4TCR ONLY Warning: Only use the cells recommended by Megger, part number 25985-031.

G BATTERY CHARGING (DET4TCR ONLY)

Warning: Whenever battery cells are being recharged, there should be no connections to the instrument terminals and the instrument should be switched off.

Warning: Do not attempt to recharge non-rechargeable (dry) cells in the DET4TCR. Doing so will result in instrument damage and may cause personal injury.

Warning: Only use the charging equipment provided by Megger for use with this instrument.

GENERAL DESCRIPTION

The Megger DET family of test instruments offers a unique solution to the measurement of earth or ground electrode (rod) resistance and soil resistivity. The family has six variants supporting 2, 3 and 4-wire measurements:

- The DET3TA provides 2 and 3-wire measurements and offers an analogue display.
- The DET3TC and DET3TD provide 2 and 3-wire measurements and offer a digital display.
- The DET4TD, DET4TC and DET4TCR provide 2, 3 and 4-wire measurement and offer a digital display.

The DET3TC, DET4TC and DET4TCR can use an optional current clamp (ICLAMP) to measure conductor current and electrode (rod) resistance without disconnection, leaving the installation earthing system intact (Attached Rod Technique, ART).

Additionally, the DET4TC and DET4TCR can drive an optional voltage-inducing clamp (VCLAMP) which, in conjunction with the ICLAMP, can be used to make stakeless measurements of the earthing system.

An explanation of the part numbering system is shown in Figure 1.

Figure 1: part numbering system

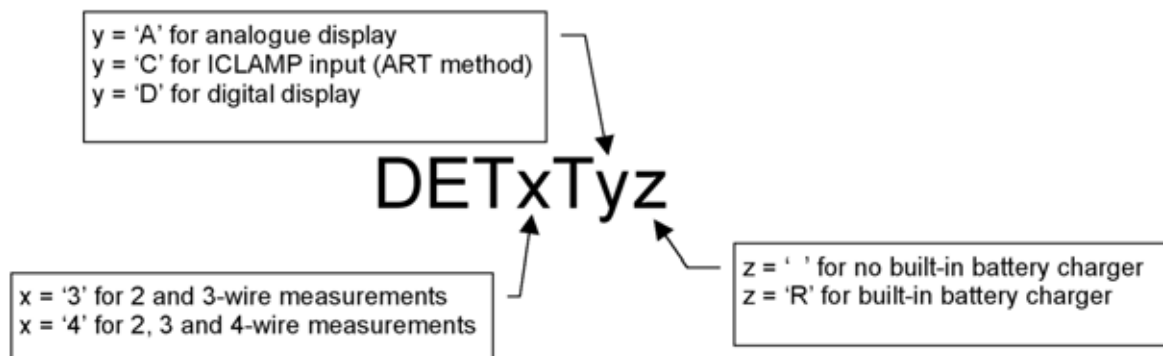

Note:

1. analogue instrument are only available with 2 and 3-wire measurements.
2. all instruments supporting ART have digital displays.

The DET family have the following features:

Feature	DET3TA	DET3TD	DET3TC	DET4TD	DET4TC	DET4TCR
Automatic C stake check		■	■	■	■	■
Automatic P stake check		■	■	■	■	■
Manual P stake check	■					
Automatic noise check		■	■	■	■	■
Manual noise check	■					
Noise rejection (40 V pk-pk)	■	■	■	■	■	■
2-wire test	■	■	■	■	■	■
3-wire test	■	■	■	■	■	■
4-wire test (2 k Ω)				■		
4-wire test (20 k Ω)					■	■
No disconnect testing (ART)			■		■	■
Stakeless measurement					■	■
Voltmeter (ground noise voltage measurement)	■	■	■	■	■	■
Current meter			■		■	■
LCD display		■	■	■	■	■
Backlit display					■	■
Moving coil meter	■					
IP54 rated	■	■	■	■	■	■
EN61010-1 100V CAT IV	■	■	■	■	■	■
Built-in battery charger						■

Each instrument kit comprises the following:

- DET instrument
- Test leads (for 3-wire instruments, lead lengths are: 3m, 10m and 15m; for 4-wire instruments: 3m, 10m, 10m and 15m)
- Test stakes (for 3-wire instruments: 2 stakes are supplied; for 4-wire instruments, 4 stakes are supplied)
- Batteries – 8x AA (LR6) alkaline (except DET4TCR)
- Batteries – 8x AA (LR6) 1800mAh NiMH (DET4TCR only)
- Warranty card
- Calibration certificate (not DET3TA)
- Owners CD-ROM manual
- Tough polypropylene carrying-case
- External AC/DC adaptor (DET4TCR only)

PREPARATIONS FOR USE

Batteries

The Megger DET series instruments are supplied with batteries fitted. When batteries become exhausted, refer to the section on battery replacement or recharging.

Warning: Do not switch the instrument on with the battery cover removed.

Inspection

Before each use of the instrument, visually inspect the instrument case, test leads, stakes and connectors to confirm that their condition is good, with no damaged or broken insulation.

GENERAL OPERATING INSTRUCTIONS

Instrument output voltage selection

The maximum output voltage of the instrument is 50 V. It is possible to reduce this to 25 V for operation in situations which require it. The most appropriate output voltage should be selected by the operator based on local safety procedures.

The procedure for changing the output voltage is as follows:

DET3TA:

1. Press and hold the **TEST** button and switch instrument ON to the **V** setting using the selector switch.
2. The needle will sweep across the scaleplate and return to the rest position. [On older DET3TC and DET3TD instruments, the firmware version will be displayed followed by 'tst'].
3. Release **TEST** button. The maximum output test voltage will be displayed, either '50 V' or '25 V'.
4. To toggle between the maximum output test voltages, press the **TEST** button.
5. Switch off instrument when the desired maximum test voltage is displayed.

DET3TC, DET3TD, DET4TD, DET4TC and DET4TCR:

1. Press the **25V/50V** button after selecting the measurement mode; the display will indicate the selected output voltage.

Note: For ART mode, the output voltage is automatically set to 25 V and cannot be changed.



Note: Some older versions of the DET3TC and DET3TD do not have the **25V/50V** button. The procedure for changing the output voltage is as per the DET3TA.







Auto power down

To extend battery life, the instrument will automatically switch off six minutes after the last operation.



The instrument can be switched back on by turning the selector switch to the **OFF** position and then selecting the desired mode of operation.

Display symbols (DET3TC, DET3TD, DET4TD, DET4TC and DET4TCR)

Symbol	Meaning
	Warning triangle. (Refer to user guide)
	Fuse blown.
	Battery indicator.
ART ✓	Situation is suitable for making ART measurements [DET3TC, DET4TC and DET4TCR only].

ART _x	Situation is not suitable for making ART measurements [DET3TC, DET4TC and DET4TCR only].
>100V	Indicates that the ground noise voltage exceeds the instrument measurement capability (test is inhibited).
Rp [✓]	Potential stake (P stake) is within range for accurate measurement.
Rp _x	Potential stake (P stake) resistance exceeds range for accurate measurement.
Rc [✓]	Current stake (C stake) is within range for accurate Measurement.
Rc _x	Current stake (C Stake) resistance exceeds range for accurate measurement.
	Ground noise voltage is within range for accurate measurement of resistance.
	Ground noise voltage exceeds range for accurate measurement of resistance.
	ICLAMP is connected; VCLAMP is connected [DET3TC, DET4TC and DET4TCR only].
	ICLAMP is not connected; VCLAMP is not connected [DET3TC, DET4TC and DET4TCR only].
	Sufficient ICLAMP current [DET3TC, DET4TC and DET4TCR only].
	Insufficient ICLAMP current [DET3TC, DET4TC and DET4TCR only].

Display symbols (DET3TA)

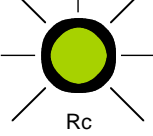
Symbol	Meaning
	Current stake (C Stake) resistance exceeds range for accurate measurement. OR Fuse blown.
	Current stake (C stake) is within range for accurate measurement.
	Instrument is performing pre-measurement checks.

INSTRUMENT ILLUSTRATIONS DET3TA

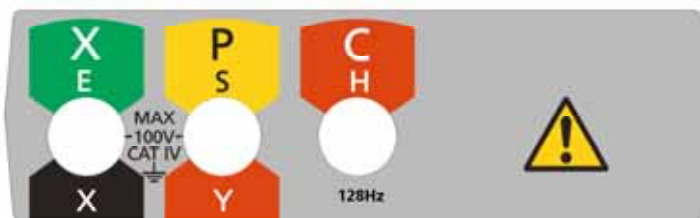
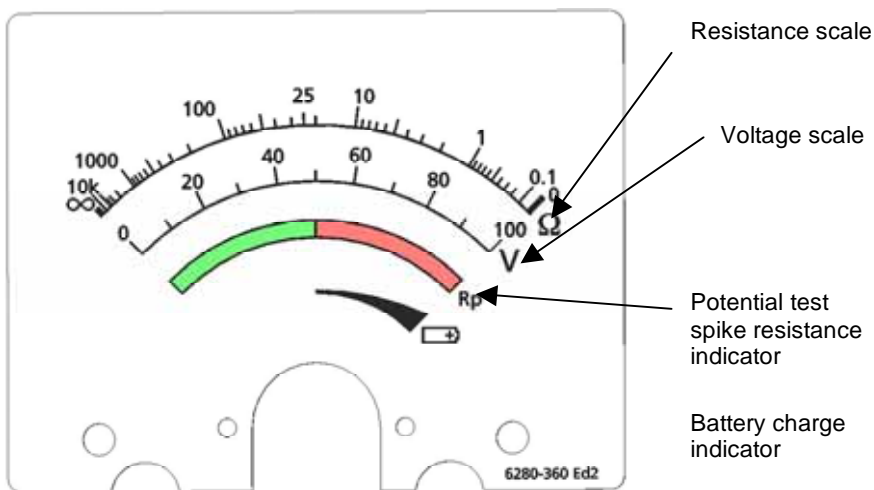
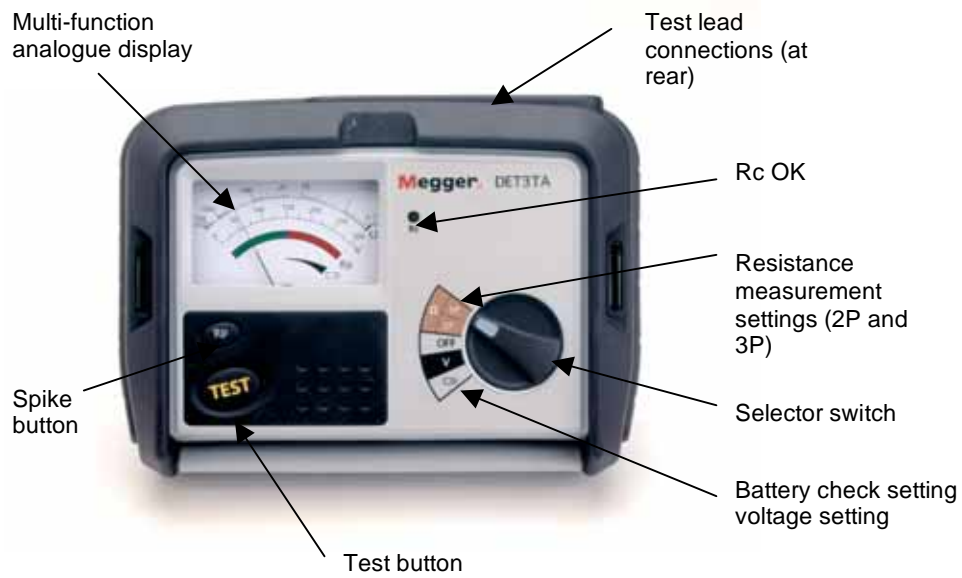

Test lead connections (at rear of instrument)

DET3TC

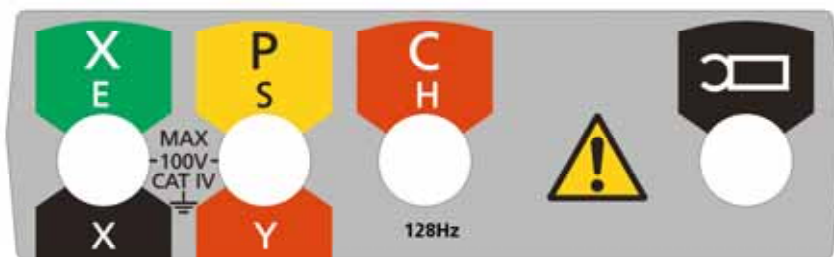
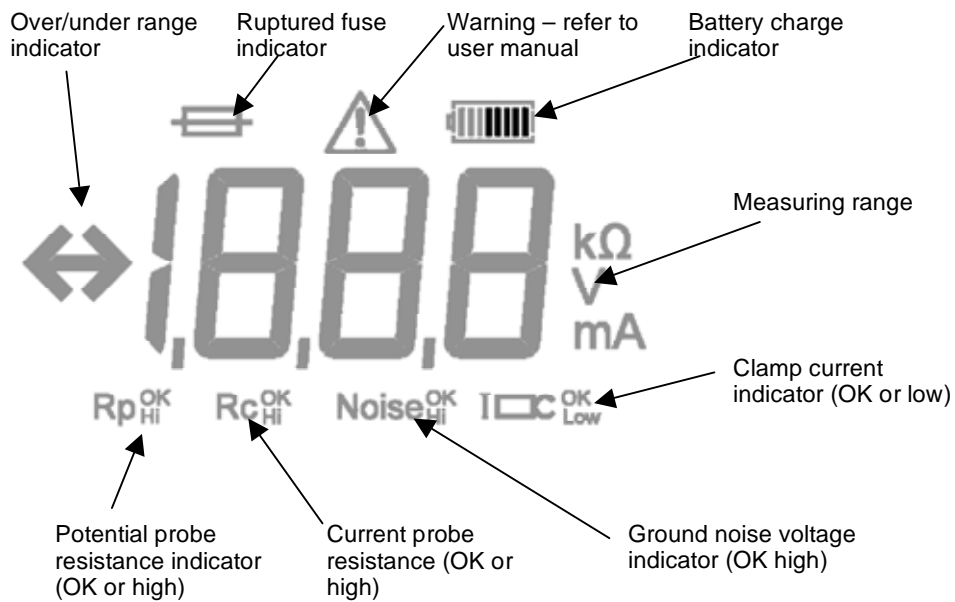
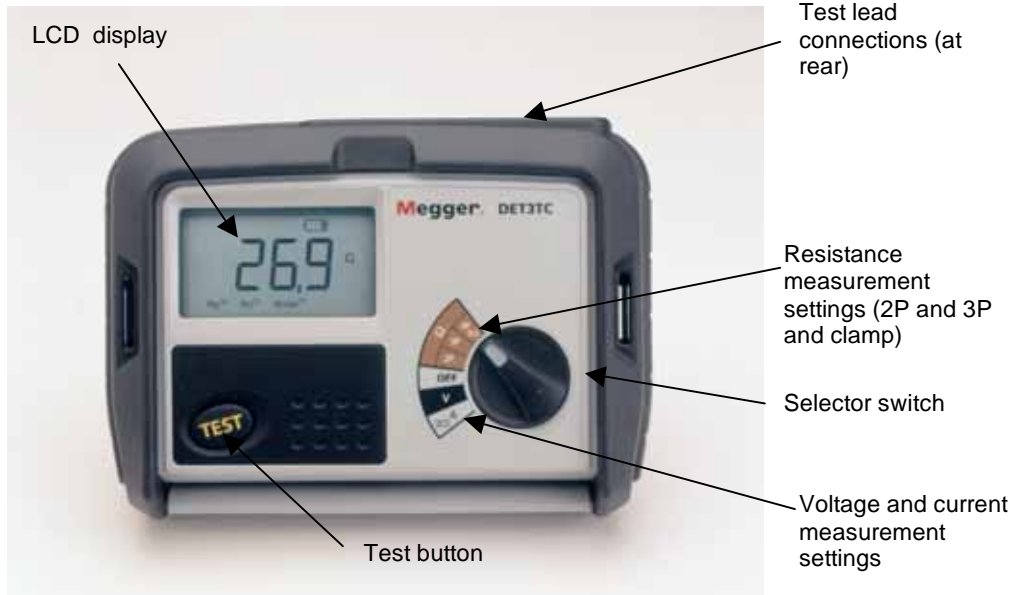

Test lead connections (at rear of instrument)

DET3TD

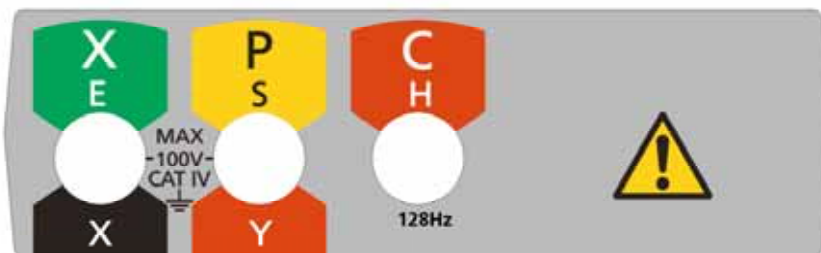
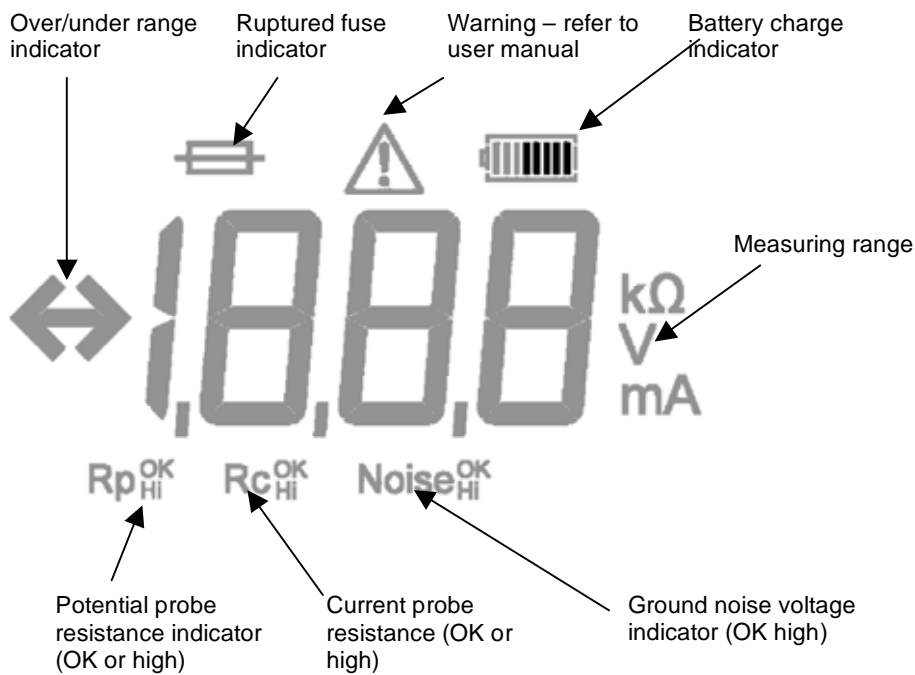
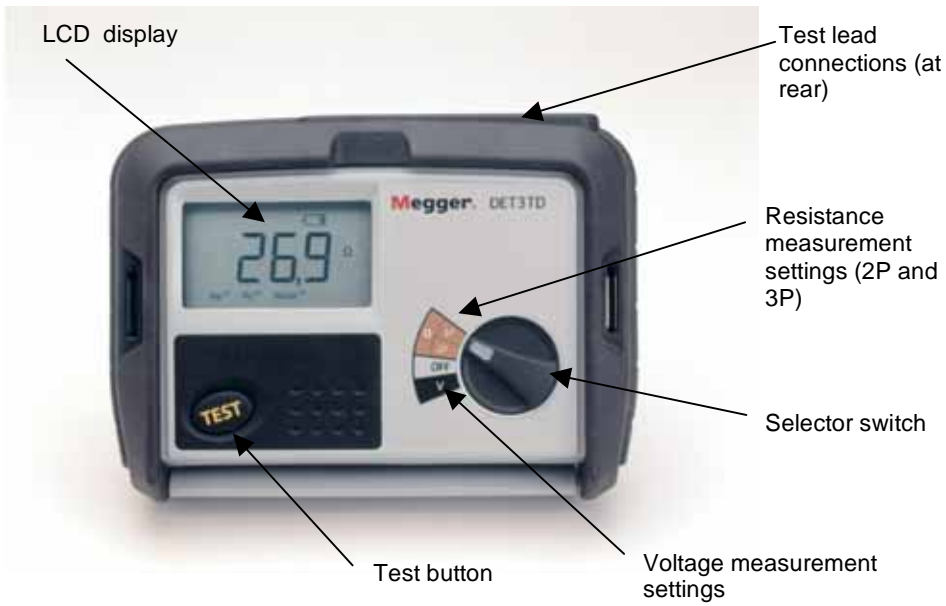

Test lead connections (at rear of instrument)

DET4TD

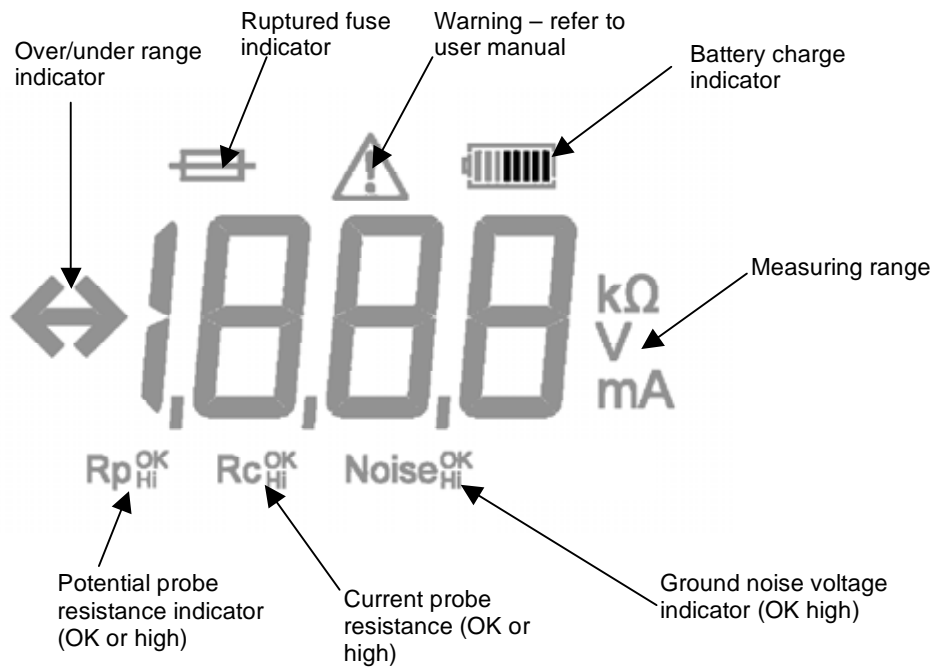
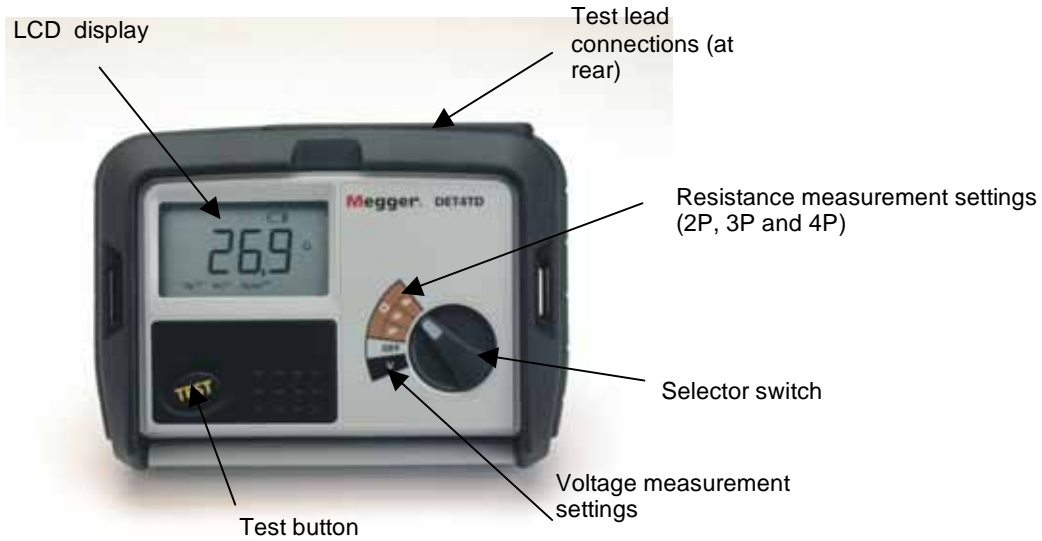

Test lead connections (at rear of instrument)

DET4TC

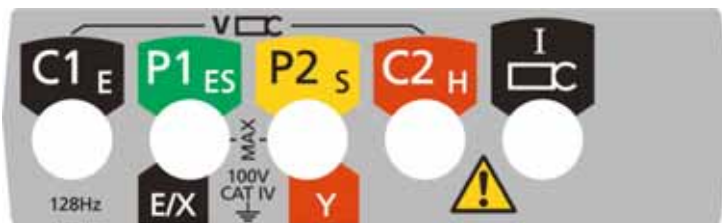
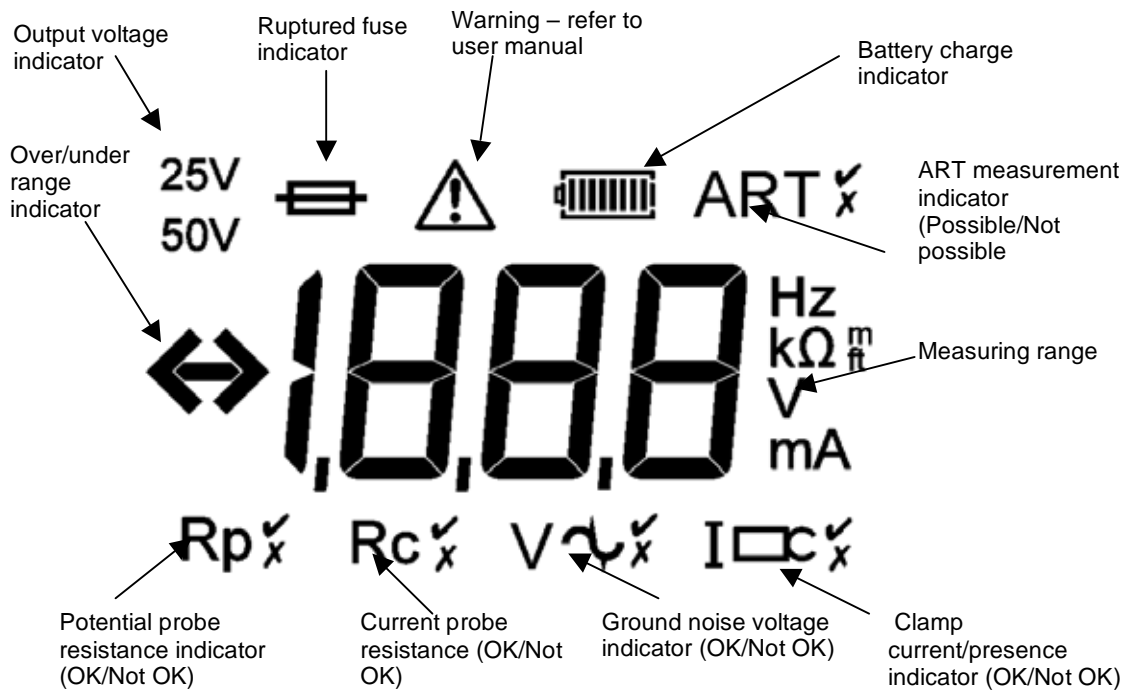
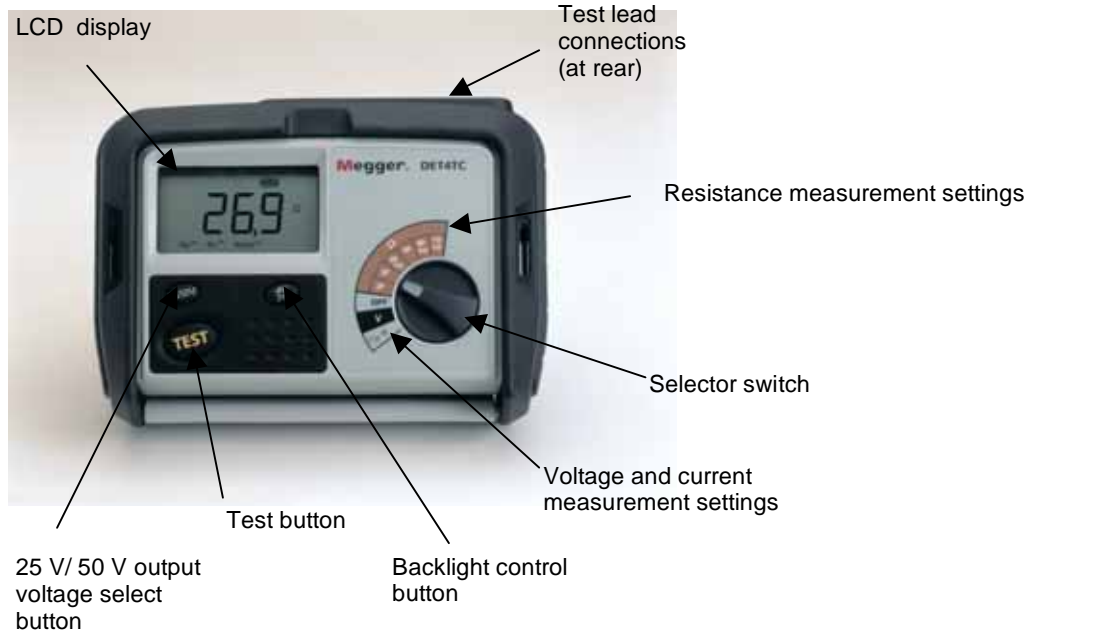

Test lead connections (at rear of instrument)

DET4TCR

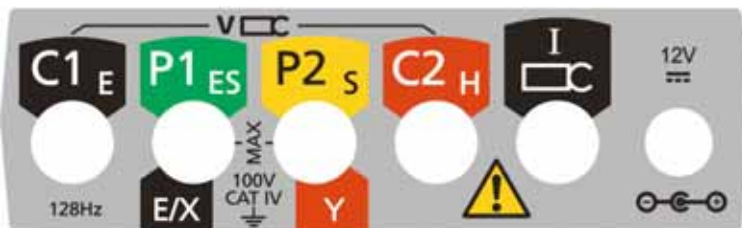
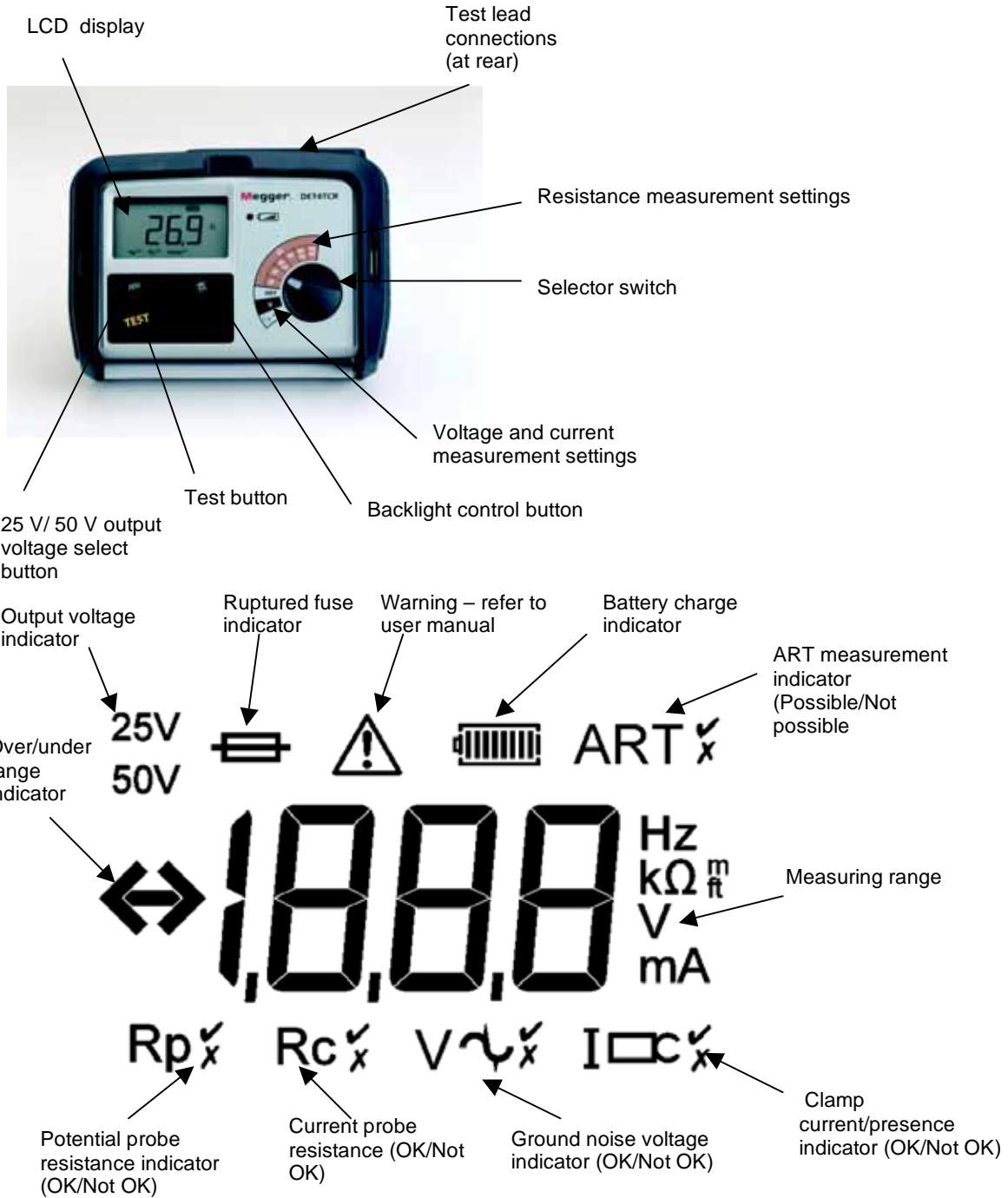



Test lead connections (at rear of instrument)

BATTERY

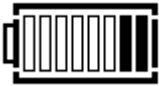
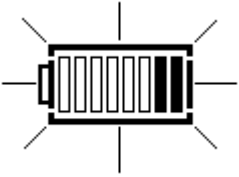
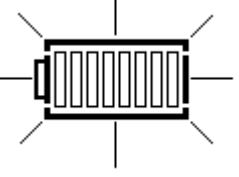

Battery status indication (DET3TC, DET3TD, DET4TD and DET4TC)

The battery condition indicator is displayed whilst the instrument is switched on as shown:

	100% battery charge remaining.
	75% battery charge remaining.
	50% battery charge remaining.
	25% battery charge remaining.
	Some charge remaining, but instrument may auto power down at any time.
	0% battery charge remaining – instrument will auto power down.

Battery status indication (DET4TCR)

The battery condition indicator is displayed whilst the instrument is switched on as shown:

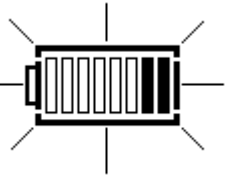
	Battery charge remaining.
	Partially charged batteries.
	Some charge remaining, but instrument may auto power down at any time.

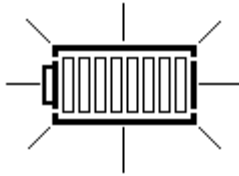

0% battery charge remaining – instrument will auto power down.

Note: If the DET4TCR's rechargeable batteries are replaced with alkaline batteries the instrument may automatically disable its charging circuit to prevent inadvertent charging of non-rechargeable cells. Follow the instructions 'Re-enabling the DET4TCR charger circuit' to switch the charger back on when the NiMH cells are re-inserted.

Battery status indication (DET3TA)

1. Set the rotary selector switch to the  position.
2. Press and hold the **TEST** button.
3. The battery charge level will be indicated on the scaleplate as shown in Figure 2.

Figure 2: battery charge level indicator



4. Release the **TEST** button.

Battery charging (DET4TCR)

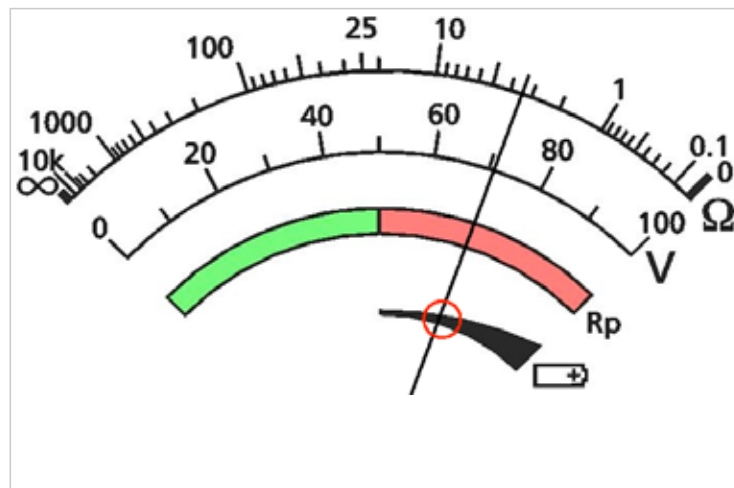
When the battery status indicator shows a nearly empty or exhausted battery, the instrument may be recharged using the following procedure.

Warning: Do not attempt to operate the instrument whilst the external AC/DC adaptor is connected.

Warning: Do not attempt to recharge non-rechargeable (dry) cells in the DET4TCR. Doing so will result in instrument damage and may cause personal injury. Only use the cells recommended by Megger.

Warning: Only use the external charging equipment provided by Megger.

1. To avoid the possibility of electric shock, switch instrument **OFF** and disconnect the instrument from any electrical circuits.
2. Move the slide on the terminal panel until the external AC/DC adaptor socket is exposed.

3. Remove the bung from the AC/DC adaptor socket.
4. Connect the AC/DC adaptor and switch on.
5. The charging cycle will commence and last approximately 15.5 hours. Follow the progress using the charge status LED as shown in Figure 3.

NOTE: The instrument ambient temperature should be between +10°C (50°F) and +40°C (105°F) during the charging cycle.

Figure 3: charge status LED progression

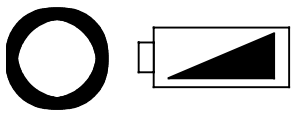
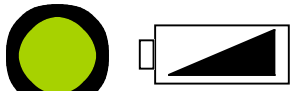
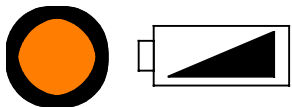
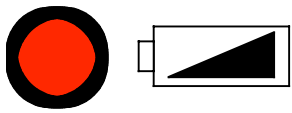
	<p>Battery charging complete.</p>
	<p>Battery charging in progress.</p>
	<p>Defective/non-rechargeable cells detected or no batteries present.</p>
	<p>Defective/non-rechargeable cells detected or no batteries present. Charging terminated.</p>

Battery type

DET3TA, DET3TC, DET3TD, DET4TD, DET4TC:

8 x AA (LR6) 1.5V Alkaline.

Megger part number: 25511-841.

DET4TCR:

8 x AA (LR6) 1.2V NiMH 1800mAh.

Megger part number: 25985-031.

Battery replacement

Battery replacement

Warning: Do not operate instrument with the battery cover removed.

Warning: Incorrect battery cell polarity can cause electrolyte leakage, resulting in damage to the instrument. If the battery condition indicator does not show a full charge when battery cells are new, a cell may be reversed.

Warning: To avoid damage by leaking electrolyte or deep discharge, do not leave cells fitted in an instrument, which will remain unused for extended periods of time.

1. To avoid the possibility of electric shock, switch instrument **OFF** and disconnect the instrument from any electrical circuits.
2. The rear cover must not be opened if the test leads are connected.

3. To avoid the possibility of electric shock, do not press the **TEST** button or touch the fuse when changing batteries.
4. To remove the rear cover, release the screw at the bottom of the cover and lift the cover upwards.
5. Remove the exhausted cells and dispose of in an appropriate manner.
6. Refit new batteries of the correct type observing the correct polarity as marked on the battery compartment.
7. Replace the instrument back cover and secure by tightening the retaining screw.

Re-enabling the battery charging circuit on the DET4TCR

If the DET4TCR's rechargeable batteries are replaced with alkaline batteries the instrument may automatically disable its charging circuit to prevent inadvertent charging of non-rechargeable cells. Follow the instructions below to switch the charger back on when the NiMH cells are re-inserted.

1. Switch the instrument on in to the **4P** position while holding down the **TEST** button. The display will carry out a self test then briefly display the software version number.
2. The screen will show the letters 'tst' – release the **TEST** button.
3. The Charger Enable Screen will be shown (see below)



4. The state of the charger circuit is shown by either a cross or a tick being shown below the letters 'CHg'. A cross indicates that the charger circuit is disabled.
5. If the cross is shown, re-enable the charger by pressing the **TEST** button once (the cross should change to a tick).
6. Switch the instrument **OFF** to save the new setting.

FUSE

Fuse status indication (DET3TC, DET3TD, DET4TD, DET4TC and DET4TCR)

The fuse blown status indicator is displayed whilst the instrument is switched on and performing a test as shown:

	Fuse blown.
---	-------------

Fuse status indication (DET3TA)

The fuse blown indication is given by the Rc LED when performing a test as shown:

	Fuse blown.
---	-------------

Fuse type

All instruments: 500 mA (F), HBC (50 kA, 600 V), 32mm x 6mm.

Megger part number: 25950-056.

Fuse replacement

Warning: Do not operate instrument with the battery cover removed.

Warning: Fitting an incorrect fuse type will reduce operator safety.

1. To avoid the possibility of electric shock, switch instrument **OFF** and disconnect the instrument from any electrical circuits.
2. The rear cover must not be opened if the test leads are connected.
3. To remove the rear cover, release the screw at the bottom of the cover and lift the cover upwards.
4. To avoid the possibility of electric shock, do not press the **TEST** button when changing the fuse.
5. Remove the ruptured fuse.
6. Refit new fuse of the correct type.
7. Replace the instrument back cover and secure by tightening the retaining screw.

DESCRIPTION OF TESTS

The description of tests contained within this user guide are instructions for the use of the DET family of instruments by competent persons.

Suitable applications

Where there is doubt about a particular application, reference should be made to the advice and guidance contained in the publication, “Getting Down to Earth” which is available from Megger, part number 21500-072.

The DET range of instruments can be used in agricultural locations (as per IEC 61557-5). In these circumstances, the output voltage should be switched to 25 V in order to comply with the standard.

Principle of operation (two-terminal resistance measurement)

This technique is used to measure the resistance between two earth points, e.g. between an earth electrode of unknown resistance and a known “good” ground connection such as metallic underground pipework or building steelwork.

The DET injects an a.c. current of known magnitude into the system under test and measures the voltage developed across it as shown in Figure 4. The system resistance is a simple ratio as per Ohm’s Law, i.e. $R=V/I$.

Figure 4: schematic for two-terminal resistance measurement

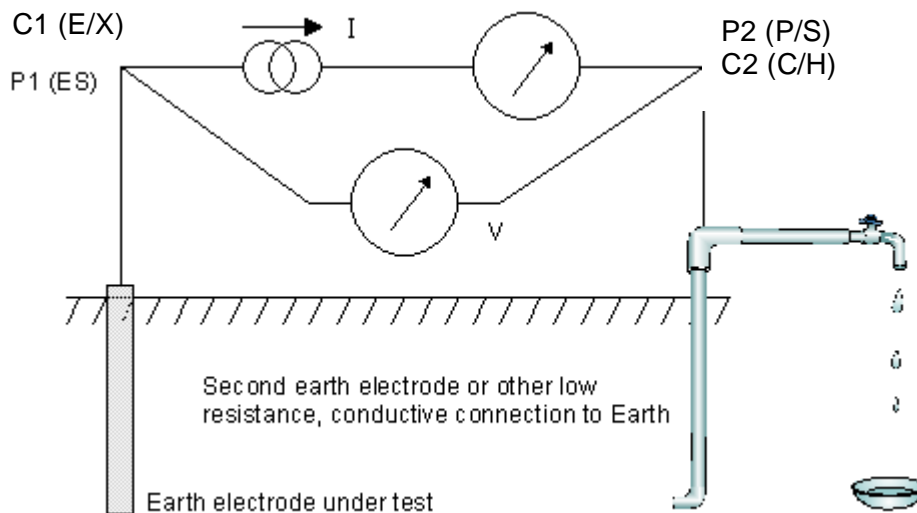

The DET instruments automatically link the **C1-P1** and **C2-P2** terminals when a two-terminal test is selected.

Principle of operation (three-terminal resistance measurement)

The classic “fall of potential” test is used to accurately measure the resistance of an earth electrode using auxiliary stakes driven into the soil, which form a circuit for the test current injection and voltage measurement as used for the two-terminal method.

The DET injects an a.c. current of known magnitude into the system under test and measures the voltage developed across it as shown in Figure 5. The system resistance is a simple ratio as per Ohm’s Law. In this case, the potential stake is moved by fixed increments in a straight line between the electrode under test and the current stake. At each location, the resistance is calculated as $R=V/I$. A graph of resistance versus potential stake position is plotted and the resistance of the electrode under test is taken to be the point at which the curve is flattest.

Empirical testing has shown that with suitably positioned stakes, this method can be shortened by placing the potential stake at a distance of approximately 62% between the electrode under test and the current stake, i.e. at $A = 0.62 \times B$.

Figure 5: schematic for three-terminal resistance measurement with lead null

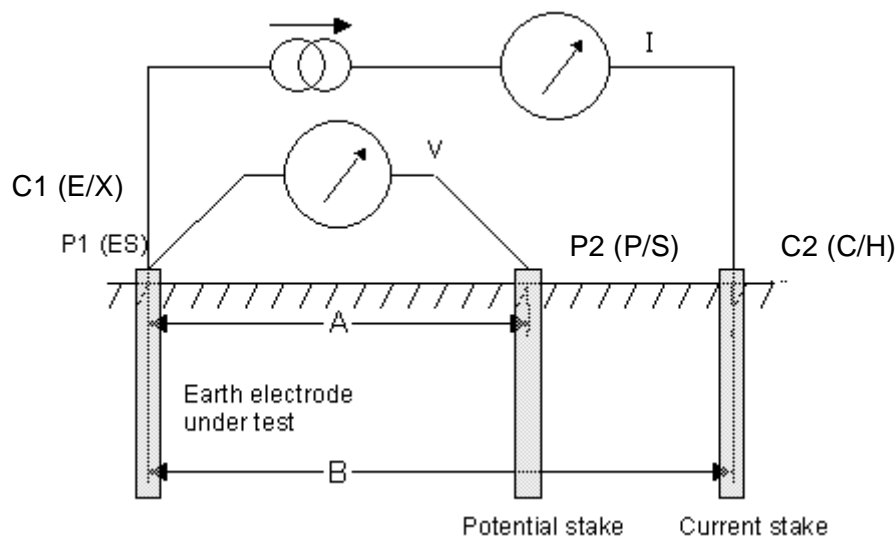

In this diagram, the **C1** and **P1** terminals are connected together at the electrode under test. This is the “three-terminal with lead null” configuration which is only applicable in four-terminal testers. This configuration allows the resistance of the **P1** lead to the electrode under test to be “nulled” out. For three-terminal testers or when lead null is not required, only the **P1** terminal (or X terminal on a three-terminal instrument) connects to the electrode under test. This is shown in Figure 6.

Figure 6: schematic for three-terminal resistance measurement without lead null

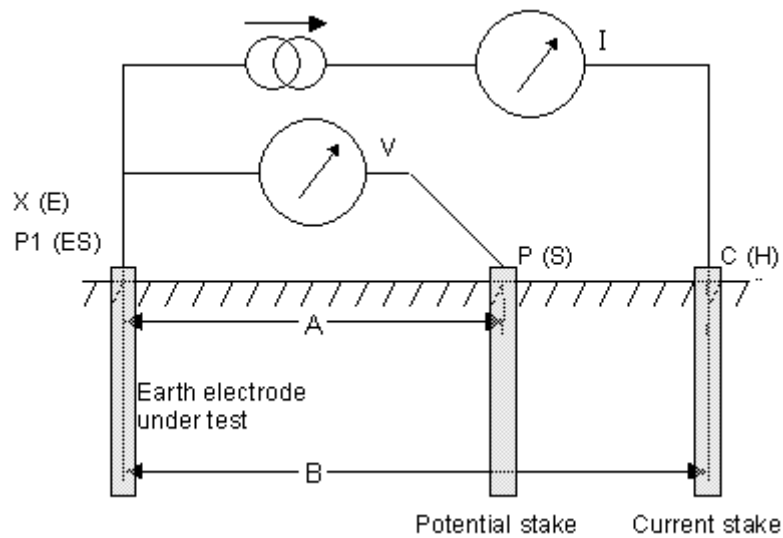

Principle of operation (three-terminal resistance measurement using ART)

The classic three-terminal test method has a disadvantage, namely that the electrode under test must be disconnected from the system it is supposed to protect in the event of a power system fault. The reason for this is that the injected test current will take all possible routes to ground and not all of it will necessarily flow through the electrode under test. In this case, the instrument will make a reading of the entire earthing network, not just the individual electrode.

By using a current transducer (the Megger ICLAMP) to measure the current flowing through the electrode under test as a fraction of the total test current injected, the instrument can determine the individual resistance. This arrangement is shown in Figure 7.

Figure 7: schematic for three-terminal resistance measurement using ART without lead null

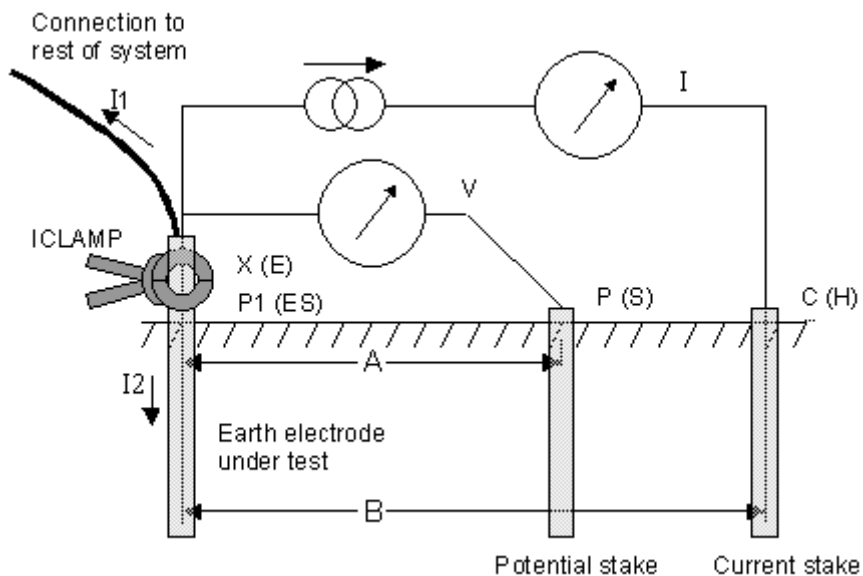

In this configuration, the injected test current I splits along two paths into I_1 (flowing into the connected earthing system) and I_2 (flowing into the electrode under test, i.e. $I=I_1+I_2$). The resistance

of the electrode under test is calculated as $R=V/I_2$ or $R=V/(I-I_1)$. The current transducer (ICLAMP) measures I_2 and feeds this value back to the instrument.

Principle of operation (two-clamp stakeless resistance measurement)

In this example, the electrode under test is connected to a network of other electrodes. It is either impractical or unsafe to disconnect an individual electrode for testing. Also, there might be insufficient space to perform a classic three-terminal resistance measurement. The stakeless test method using both VCLAMP and ICLAMP can be used to obtain a measurement for the electrode under test.

A defined test voltage is injected into the system using the VCLAMP, inducing a current, I , to flow and be measured by the ICLAMP. The model shown in Figure 8 can be simplified to the resistance of the electrode under test, R_x and the resistance of the other electrodes in parallel, i.e. $R_1 || R_2 || \dots || R_n$. Therefore, the current induced by the test voltage is $I=V/[R_x+(R_1 || R_2 || \dots || R_n)]$. It follows that as the resistance of the other electrodes in parallel approaches zero, then the resistance measured, approaches the value of the electrode under test.

Figure 8: schematic for two-clamp stakeless resistance measurement

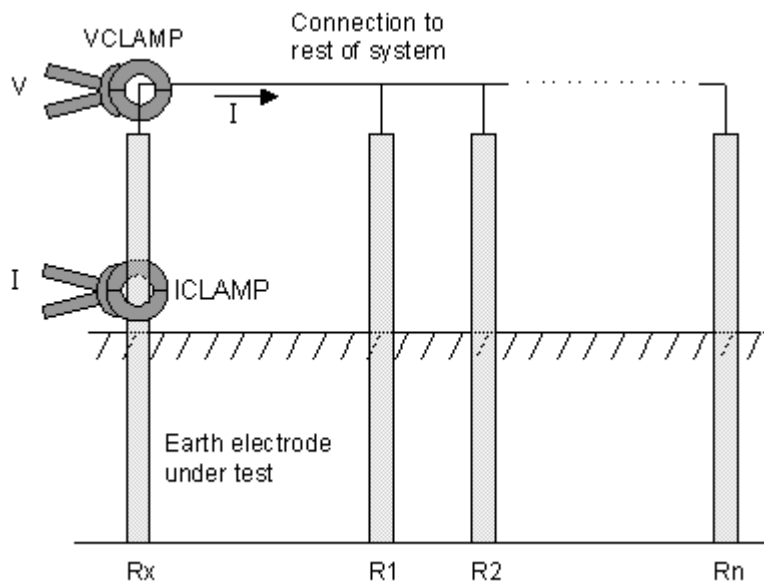

Principle of operation (four-terminal resistivity measurement)

The soil resistivity measurement works on a similar principle to the other measurements which use stakes: a current is injected around an outer loop and a voltage measured, shown in Figure 9. In this case, however, the measurement made by the instrument requires further conversion using a formula to derive the volumetric soil resistivity from the resistance value display.

Figure 9: schematic for 4-terminal resistivity measurement

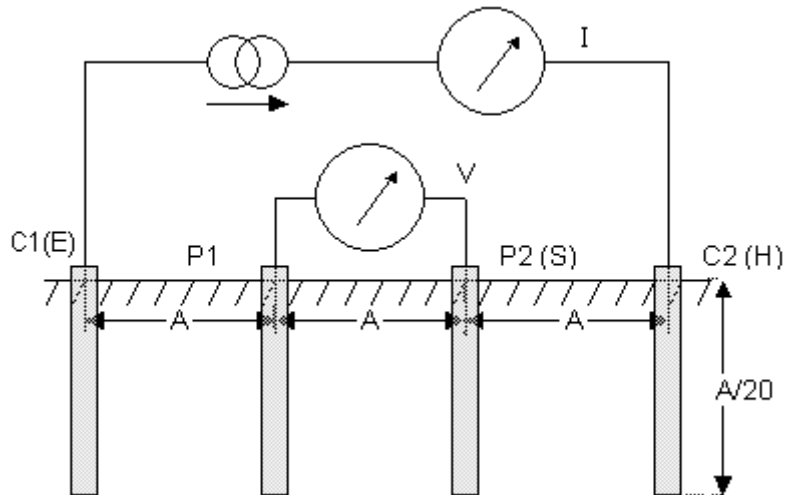

For this test, the relative spacing and depth of the stakes is important. When configured as shown in Figure 9, the soil resistivity can be calculated from the resistance value, R , displayed on the instrument as $\rho = 2 \times \pi \times A \times R$.

Measurement of ground noise voltage (DET3TC, DET3TD, DET4TD, DET4TC and DET4TCR)

1. Ensure the rotary selector switch is in the **OFF** position.
2. Connect the instrument as shown in Figure 10.

Figure 10: instrument connection for measuring ground noise voltage

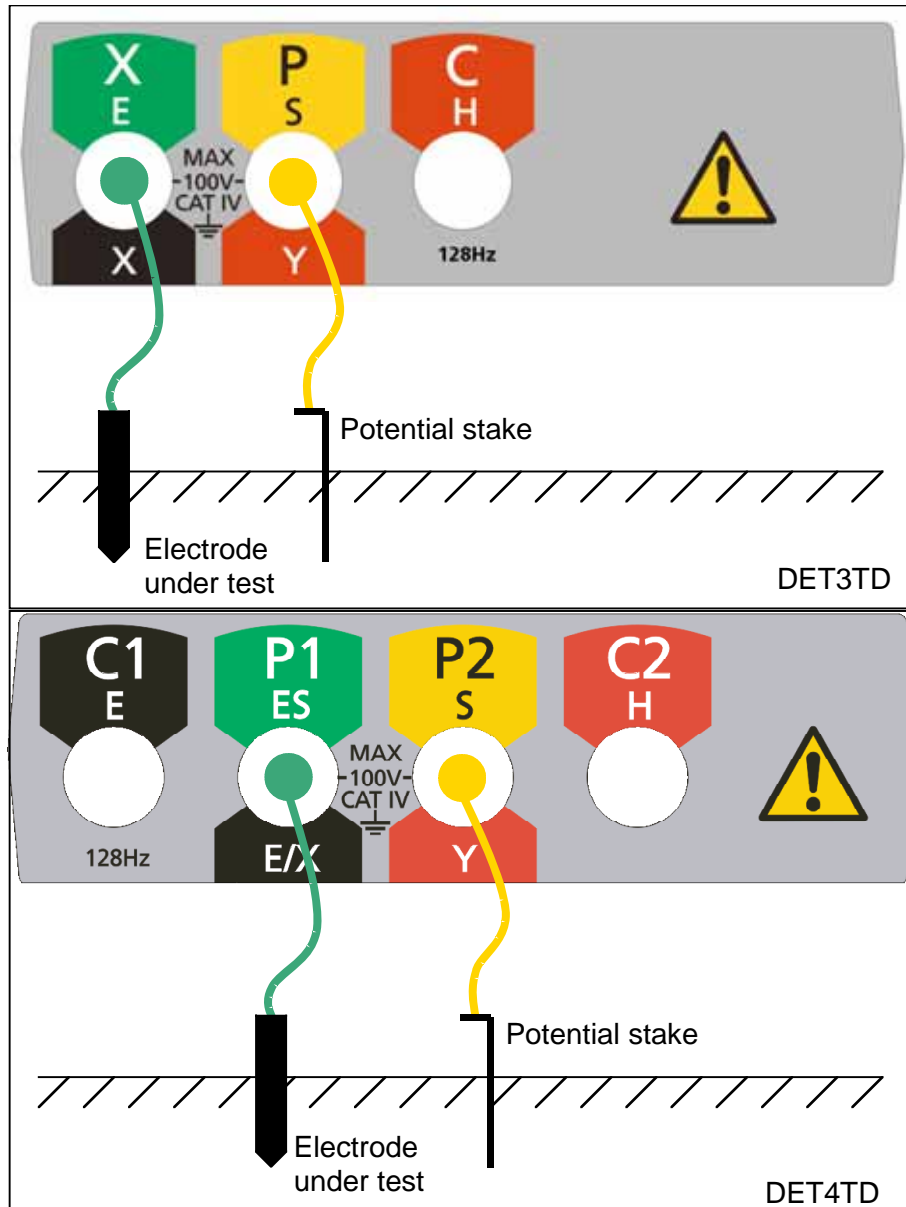

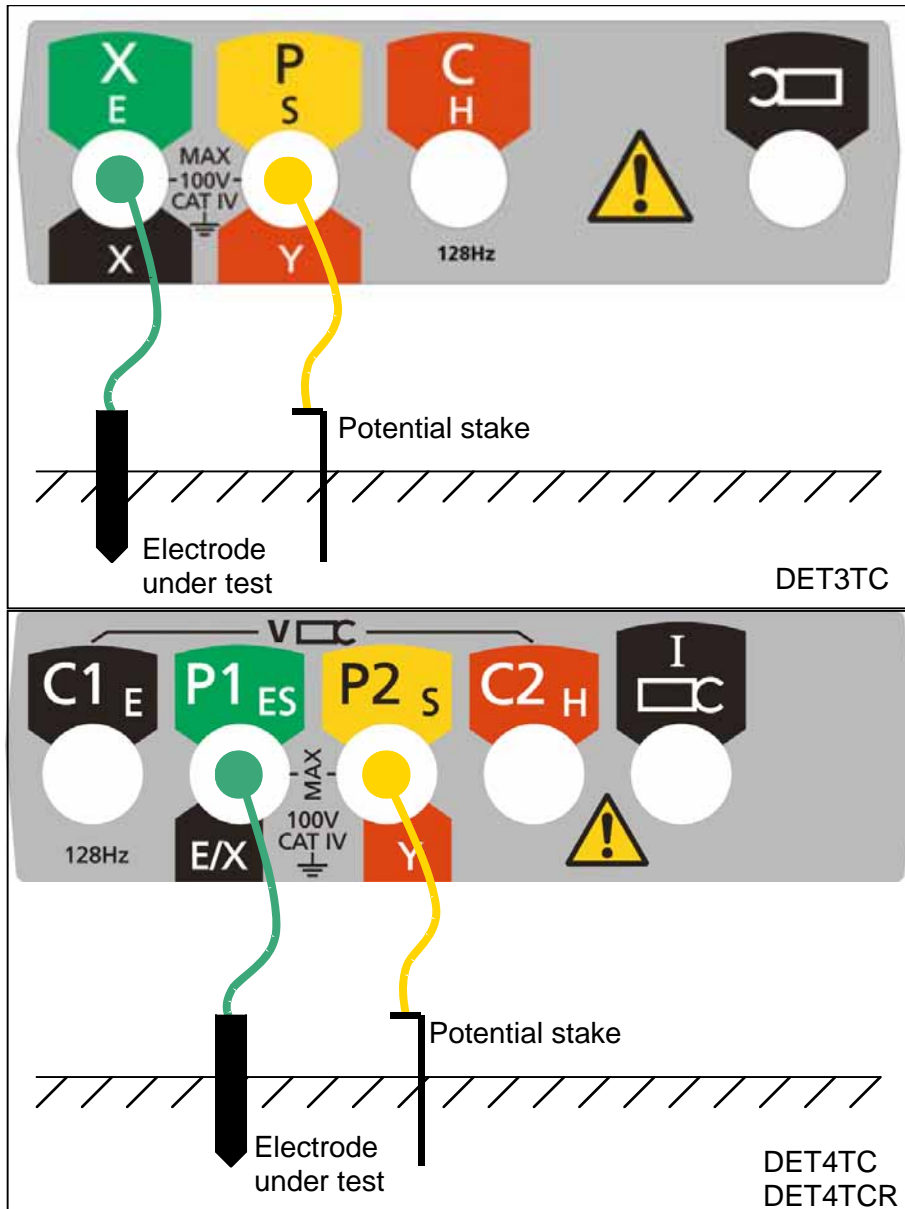

3. Set the rotary selector switch to the **V** position.
4. The ground noise voltage reading will be displayed as shown in Figure 11.

Figure 11: example ground noise voltage reading (DET4TC / DET4TCR display shown)

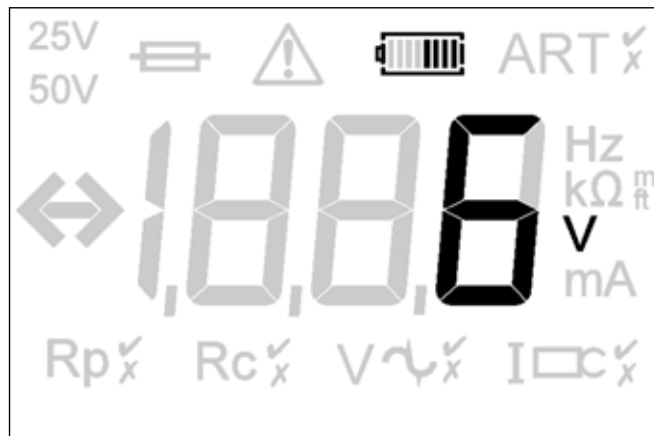

Note:

- The instrument will display the warning triangle and an excessive noise voltage indicator above 40 V pk-pk (14 Vrms).
- The instrument will display the warning triangle and an over-range condition above 100 V.

Measurement of ground noise voltage (DET3TA)

1. Ensure the rotary selector switch is in the **OFF** position.
2. Connect the instrument as shown in Figure 12.

Figure 12: instrument connection for measuring ground noise voltage

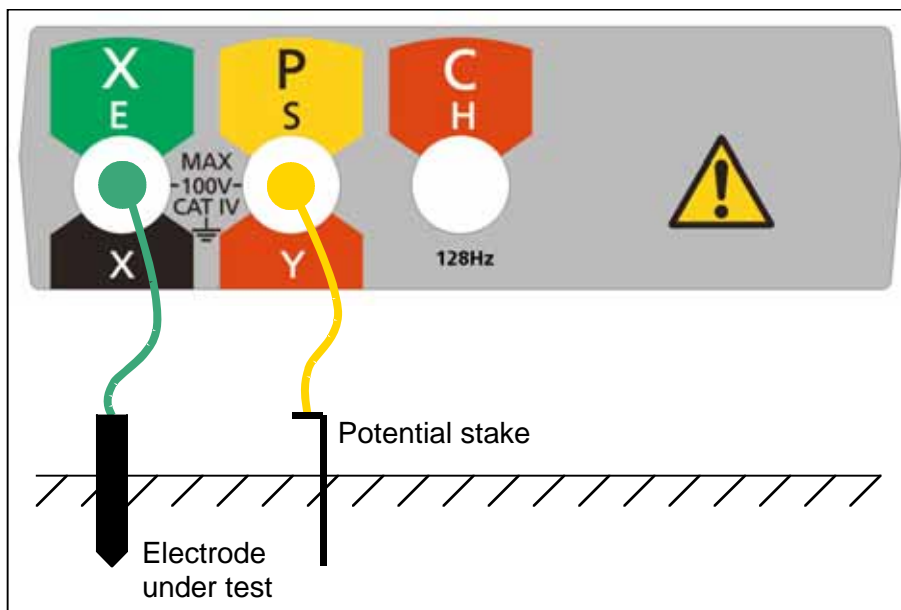

3. Set the rotary selector switch to the **V** position.
4. The ground noise voltage reading will be indicated on the scaleplate as shown in Figure 13.

Figure 13: example ground noise voltage reading

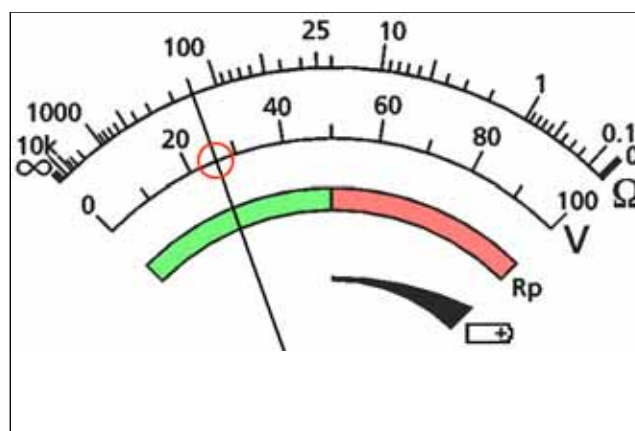

Two-terminal resistance measurement (DET3TC, DET3TD, DET4TD, DET4TC and DET4TCR)

1. Ensure the rotary selector switch is in the **OFF** position.
2. Connect the instrument as shown in Figure 14.

Figure 14: instrument connection for measuring two-terminal resistance

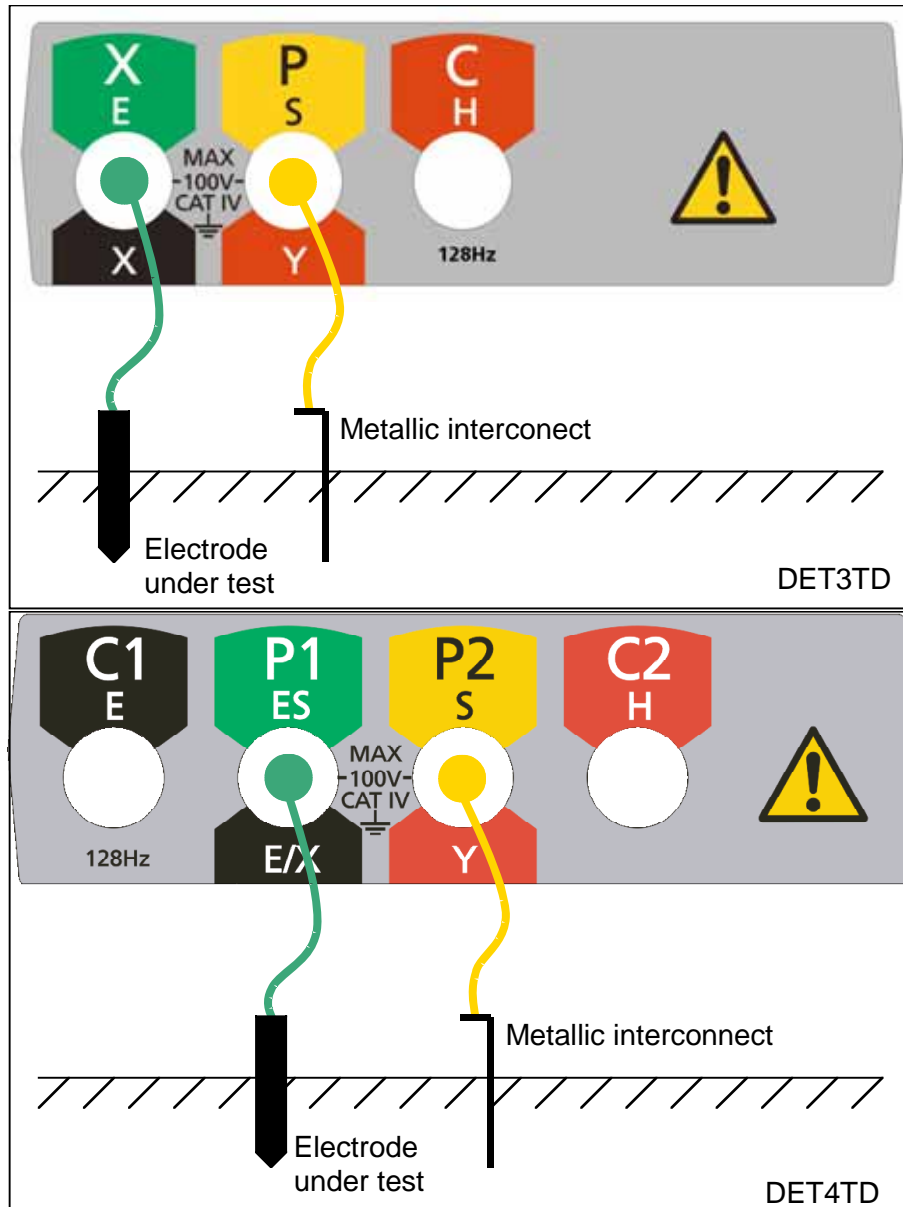

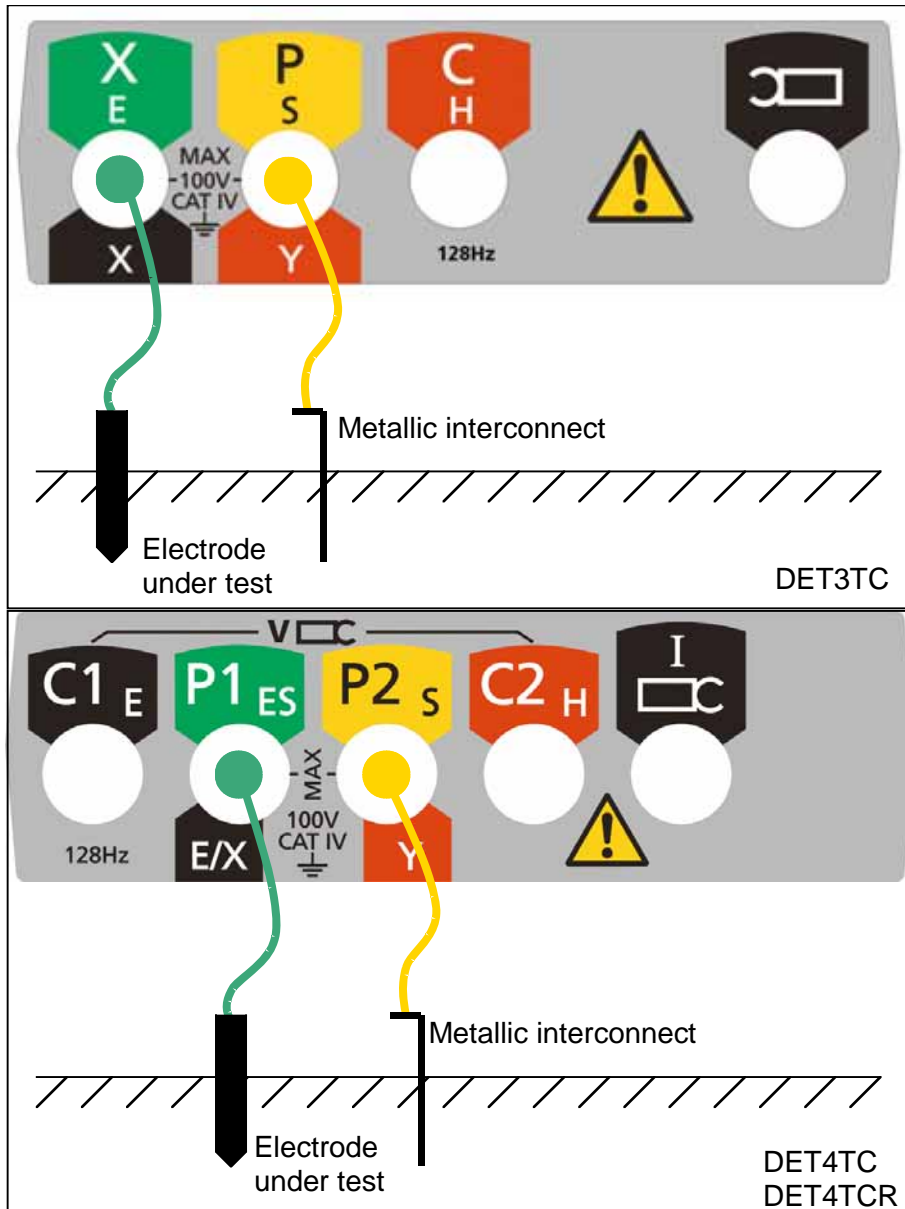

3. Set the rotary selector switch to the **2P** position.
4. Select the desired test voltage using the **25V/50V** button.
5. Press and release the **TEST** button [by holding the **TEST** button, the resistance measurement will be continually updated].
6. The instrument will perform pre-measurement check, the status of which will be indicated on the display.
7. The two-terminal resistance reading will be displayed as shown in Figure 15.

Figure 15: example two-terminal resistance reading (DET4TC / DET4TCR display shown)

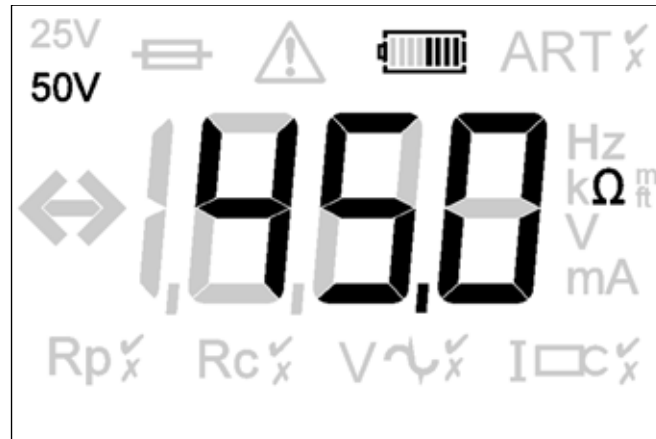

Note:

- The test voltage used to make the two-terminal resistance reading is a.c. and may not be suitable for continuity testing according to some local regulations.
- The instrument will display the warning triangle and an excessive noise voltage indicator if the ground noise voltage is above 40 V pk-pk (14 Vrms).
- The instrument will display the warning triangle and a voltage over-range condition if the ground noise voltage is above 100 V – no resistance reading is possible under these conditions.

Two-terminal resistance measurement (DET3TA)

1. Ensure the rotary selector switch is in the **OFF** position.
2. Select the desired test voltage using the procedure in the section on General Operating Instructions.
3. Connect the instrument as shown in Figure 16.

Figure 16: instrument connection for measuring two-terminal resistance

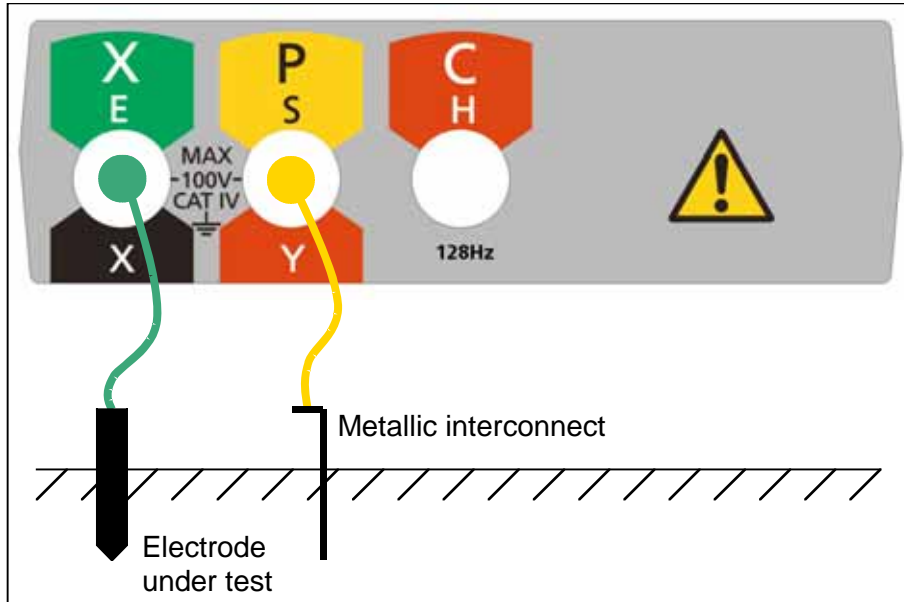

4. Set the rotary selector switch to the **2P** position.
5. The ground noise voltage will be indicated on the scale plate as shown in Figure 17.

Figure 17: ground noise voltage indication

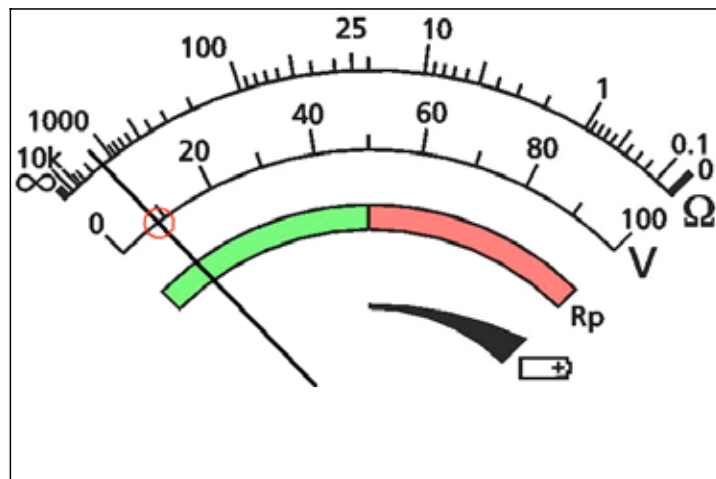

6. If the ground noise voltage is less than 40 V pk-pk (14 V rms), press and hold the **TEST** button. [Testing will be inhibited if the ground noise voltage exceeds 40 V pk-pk.]
7. The Rc LED will flash to indicate that the instrument is carrying out pre-measurement checks.

8. If the Rc LED does not illuminate following the pre-measurement checks, this indicates that the instrument fuse has ruptured.
9. If the Rc LED illuminates solidly following the pre-measurement checks, this indicates that a two-terminal measurement can be made.
10. The two-terminal resistance reading will be indicated on the scaleplate as shown in Figure 18.

Figure 18: example two-terminal resistance reading

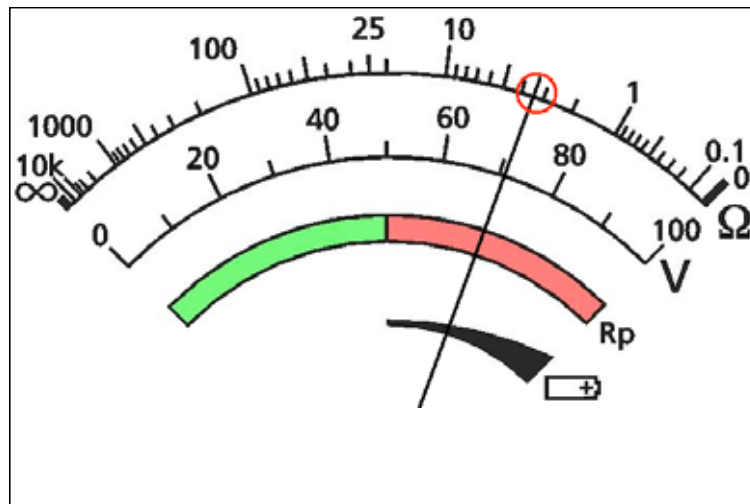

Note:

- The test voltage used to make the two-terminal resistance reading is a.c. and may not be suitable for continuity testing according to some local regulations.
- No resistance reading is possible if the ground noise voltage exceeds 100 V.

Three-terminal resistance measurement (DET3TC, DET3TD, DET4TD, DET4TC and DET4TCR)

1. Ensure the rotary selector switch is in the **OFF** position.
2. Connect the instrument as shown in Figure 19.

Figure 19: instrument connection for measuring three-terminal resistance

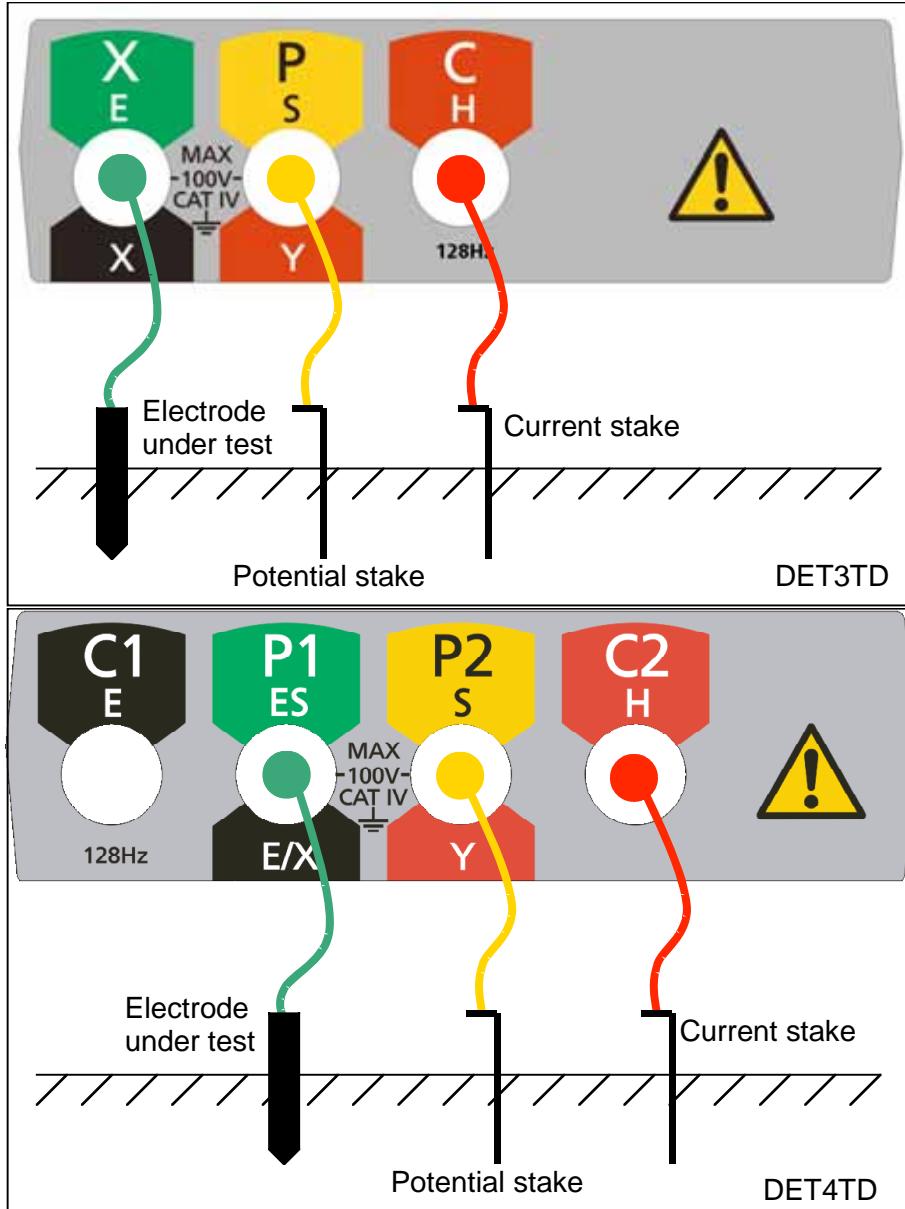

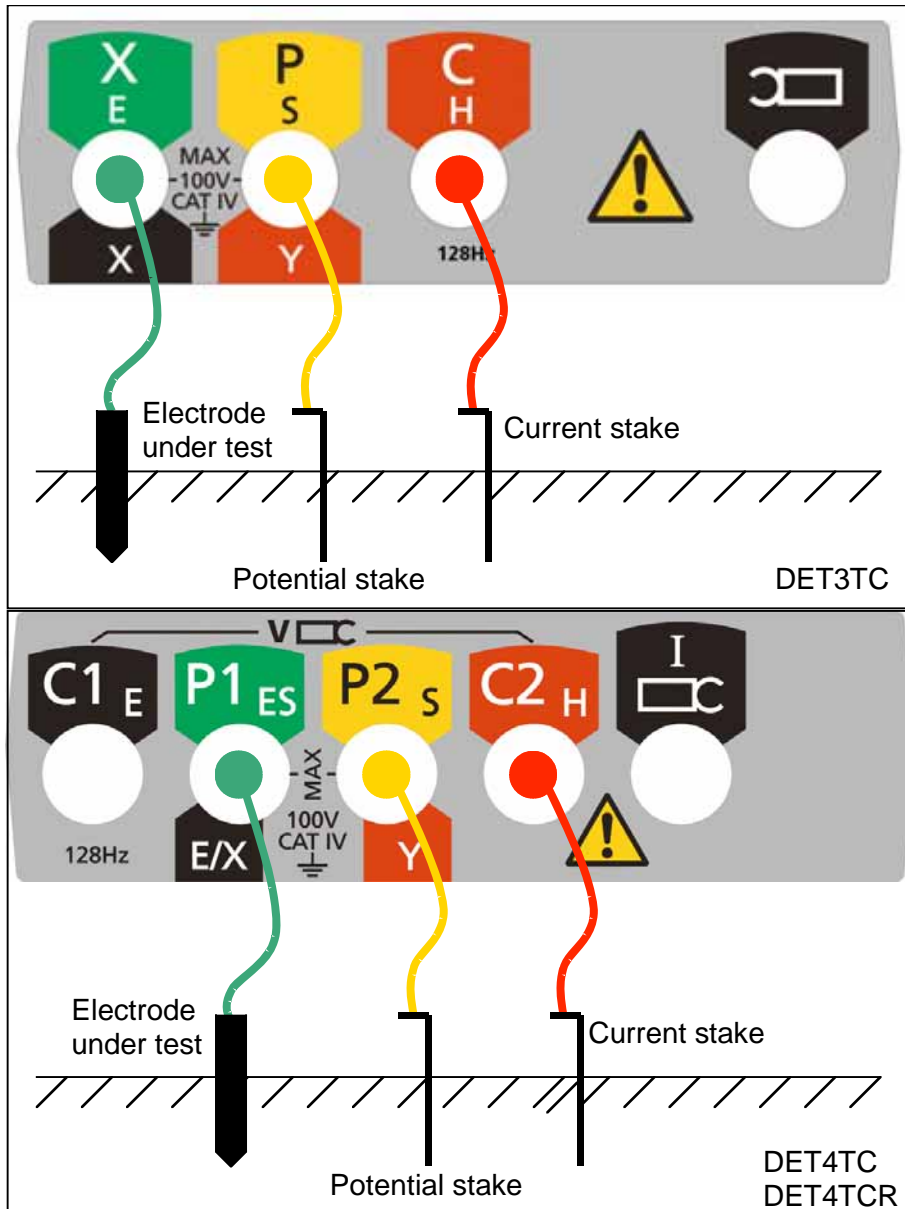

3. Set the rotary selector switch to the **3P** position.
4. Select the desired test voltage using the **25V/50V** button.
5. Press and release the **TEST** button [by holding the **TEST** button, the resistance measurement will be continually updated].
6. The instrument will perform pre-measurement check, the status of which will be indicated on the display.
7. The three-terminal resistance reading will be displayed as shown in Figure 20.

Figure 20: example three-terminal resistance reading (DET4TC / DET4TCR display shown)



Note:

- The instrument will display the warning triangle and an excessive noise voltage indicator if the ground noise voltage is above 40 V pk-pk (14 Vrms).
- The instrument will display the warning triangle and a voltage over-range condition if the ground noise voltage is above 100 V – no resistance reading is possible under this condition.

Three-terminal resistance measurement (DET3TA)

1. Ensure the rotary selector switch is in the **OFF** position.
2. Select the desired test voltage using the procedure in the section on General Operating Instructions.
3. Connect the instrument as shown in Figure 21.

Figure 21: instrument connection for measuring three-terminal resistance

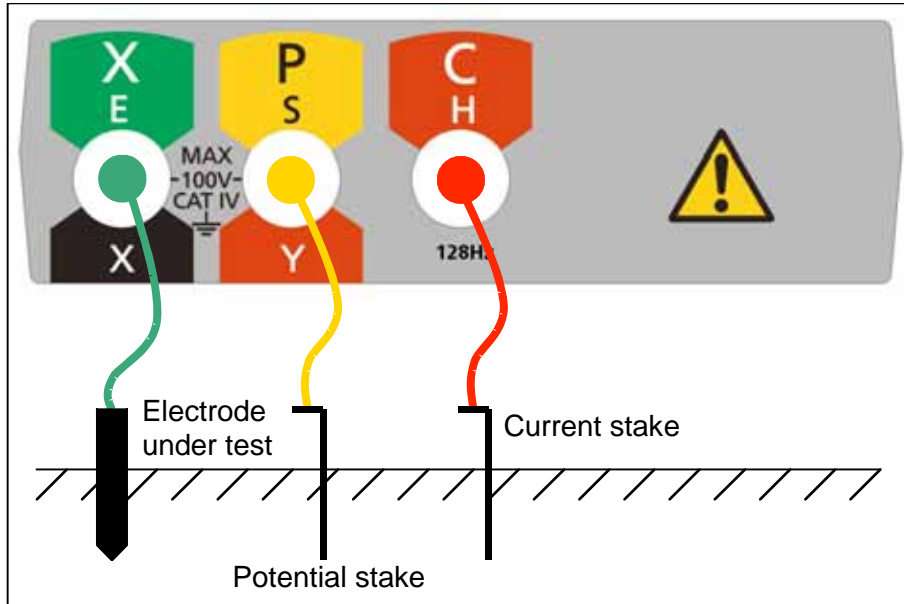

4. Set the rotary selector switch to the **3P** position.
5. The ground noise voltage will be indicated on the scaleplate as shown in Figure 22.

Figure 22: ground noise voltage indication

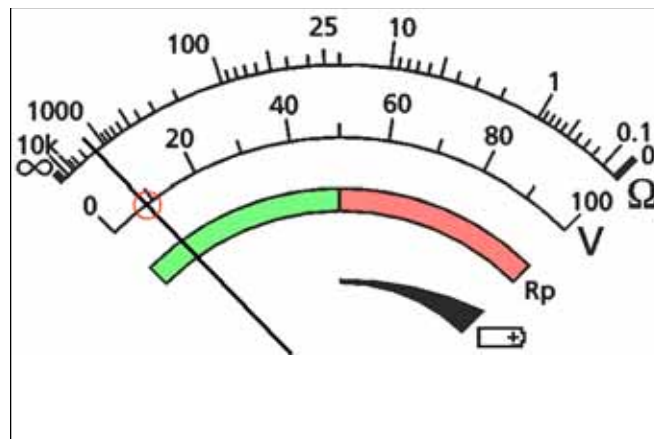

6. If the ground noise voltage is less than 40Vpk-pk (14Vrms), press and hold the **Rp** button. [Testing will be inhibited if the ground noise voltage exceeds 40Vpk-pk.]
7. The P stake resistance will be indicated on the scaleplate: the needle will move into the green region (Figure 23) if the P stake resistance is within limits for an accurate measurement and into the red region (Figure 24) if the P stake resistance exceeds the limits for an accurate measurement.

Figure 23: P stake resistance OK (green region)

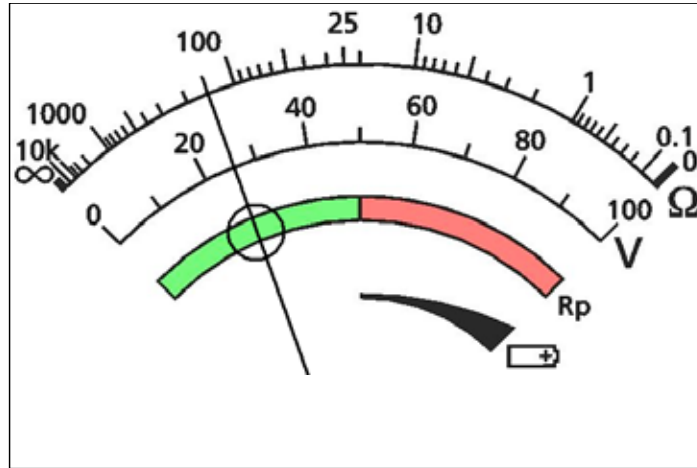
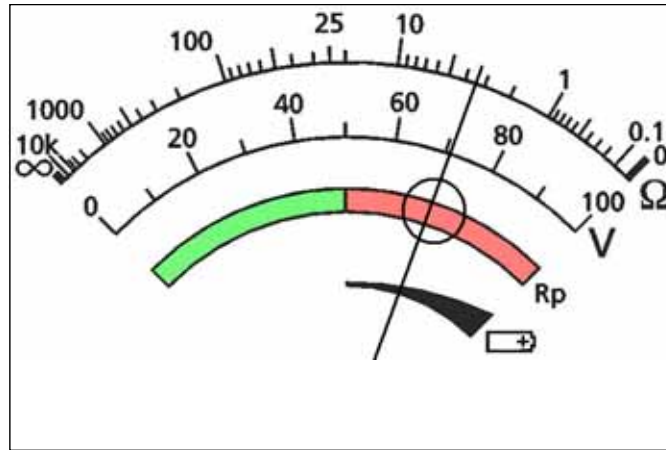
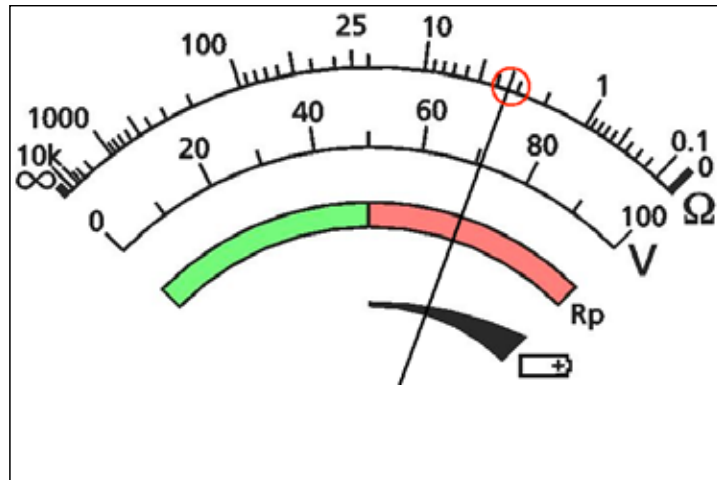

Figure 24: P stake resistance not OK (red region)



8. If the P stake resistance is acceptable (needle in the green region of the scaleplate), release the **R_p** button.
9. Press and hold the **TEST** button.
10. The R_c LED will flash to indicate that the instrument is carrying out pre-measurement checks.
11. If the R_c LED does not illuminate following the pre-measurement checks, this indicates that the C stake resistance exceeds the limits for an accurate measurement or that the instrument fuse has ruptured.
12. If the R_c LED illuminates solidly following the pre-measurement checks, this indicates that a three-terminal measurement can be made.
13. The three-terminal resistance reading will be indicated on the scaleplate as shown in Figure 25.

Figure 25: example three-terminal resistance reading



Note:

- No resistance reading is possible if the ground noise voltage exceeds 100 V.

Three-terminal resistance measurement with lead null (DET4TD, DET4TC and DET4TCR)

In certain circumstances, the resistance of the test lead connecting to the electrode under test may itself form a significant part of the measurement electrode resistance. This effect can be eliminated using the lead-null technique described in this section.

1. Ensure the rotary selector switch is in the **OFF** position.
2. Connect the instrument as shown in Figure 26.

Figure 26: instrument connection for measuring three-terminal resistance with lead-null

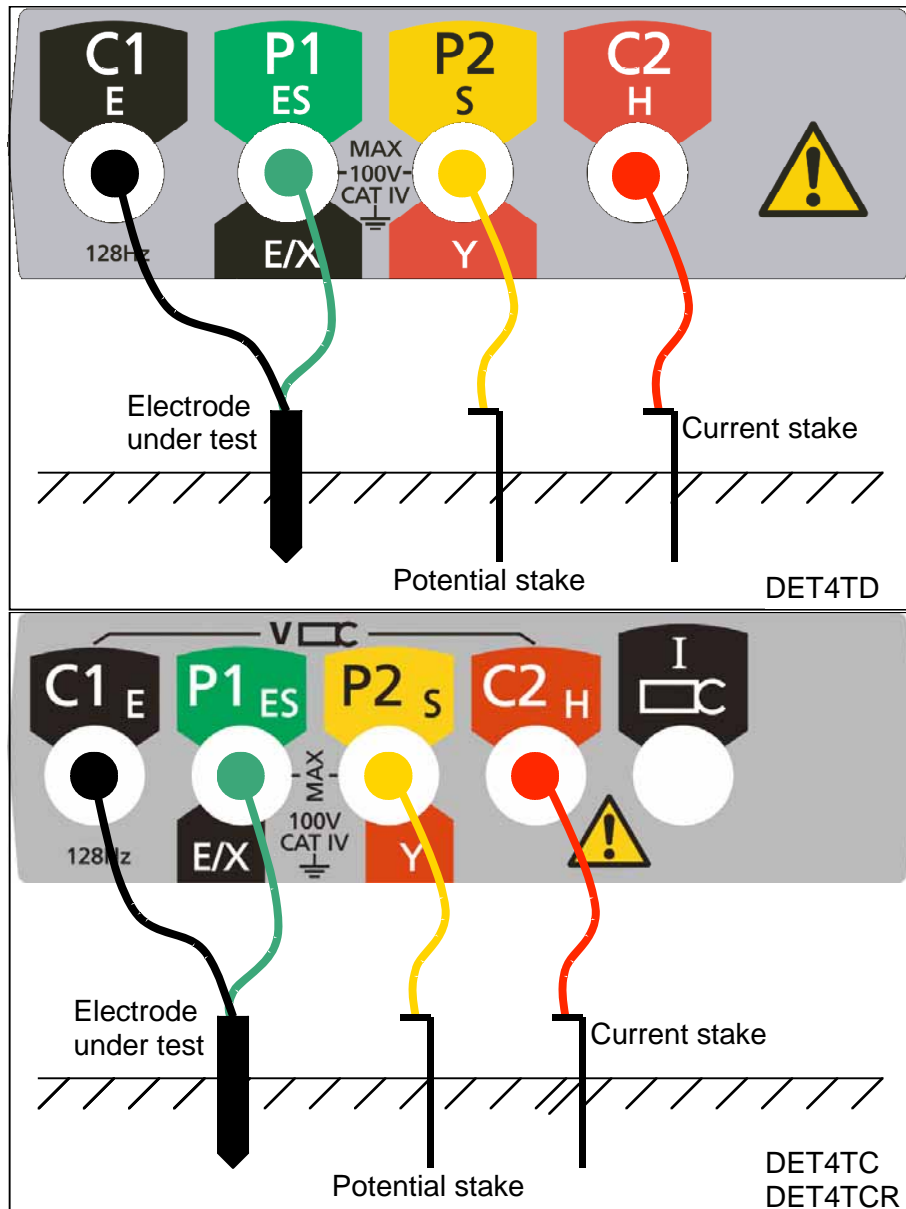

3. Set the rotary selector switch to the **4P** position.
4. Select the desired test voltage using the **25 V/50 V** button.
5. Press and release the **TEST** button [by holding the **TEST** button, the resistance measurement will be continually updated].

6. The instrument will perform pre-measurement check, the status of which will be indicated on the display.
7. The three-terminal resistance with lead-null reading will be displayed as shown in Figure 27.

Figure 27: example three-terminal resistance with lead-null reading (DET4TC / DET4TCR display shown)



Note:

- The instrument will display the warning triangle and an excessive noise voltage indicator if the ground noise voltage is above 40 V pk-pk (14 Vrms).
- The instrument will display the warning triangle and a voltage over-range condition if the ground noise voltage is above 100 V – no resistance reading is possible under this condition.

Four-terminal resistivity measurement (DET4TD, DET4TC and DET4TCR)

The DET4TD, DET4TC and DET4TCR can be used to make soil resistivity measurements. The resistivity value can be derived from the four-terminal resistance reading made by the instrument and the particular separation and depth of the stakes.

1. Ensure the rotary selector switch is in the **OFF** position.
2. Connect the instrument as shown in Figure 28.

Figure 28: instrument connection for measuring four-terminal resistance

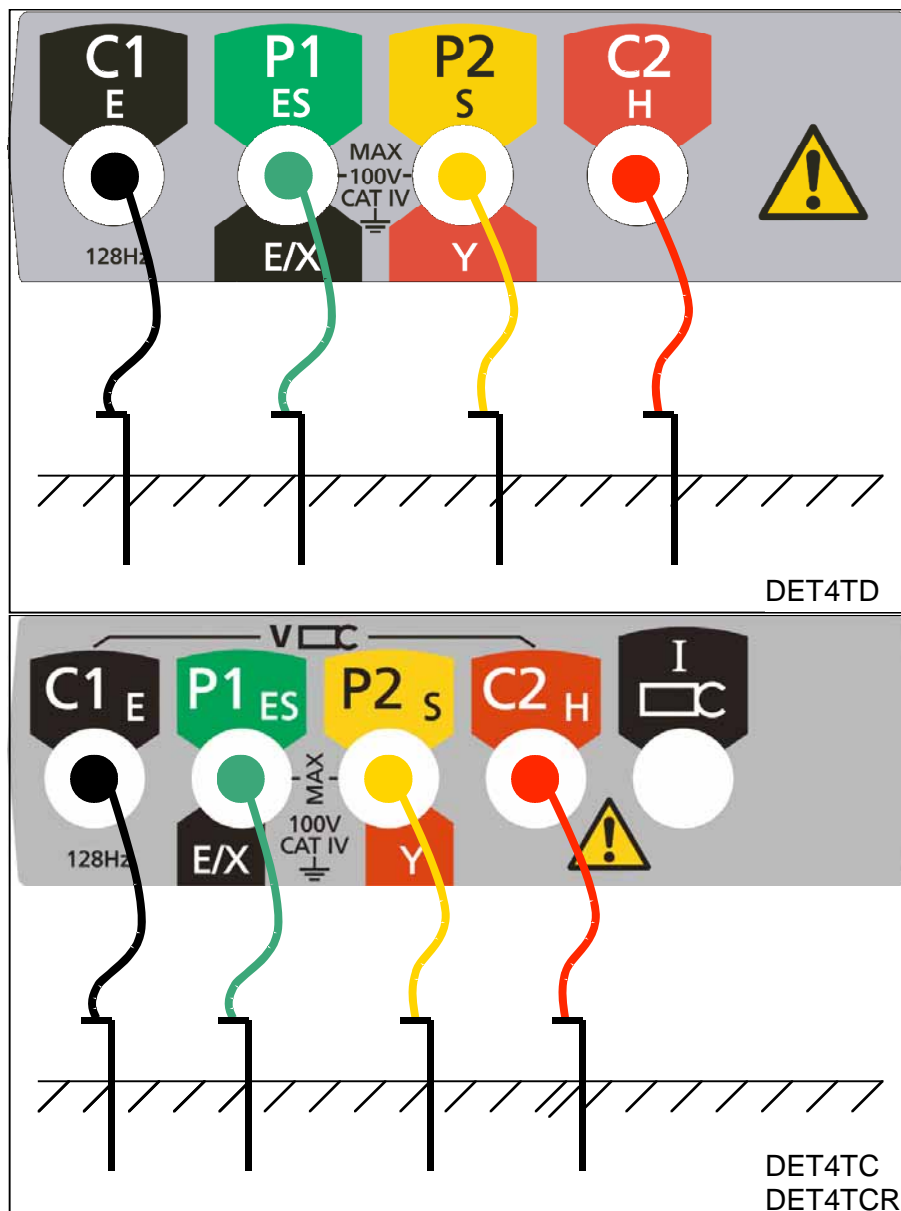

3. Set the rotary selector switch to the **4P** position.
4. Select the desired test voltage using the **25 V/50 V** button.
5. Press and release the **TEST** button [by holding the **TEST** button, the resistance measurement will be continually updated].

6. The instrument will perform pre-measurement check, the status of which will be indicated on the display.
7. The four-terminal resistance reading will be displayed as shown in Figure 29.

Figure 29: example four-terminal resistance reading (DET4TC / DET4TCR display shown)



8. A soil resistivity value can be derived from the resistance reading and the stake geometry.

Note:

- The instrument will display the warning triangle and an excessive noise voltage indicator if the ground noise voltage is above 40 V pk-pk (14 Vrms).
- The instrument will display the warning triangle and a voltage over-range condition if the ground noise voltage is above 100 V – no resistance reading is possible under this condition.

Measurement of ground current (DET3TC, DET4TC and DET4TCR)

Before measuring ground current, please follow the procedure contained in the section on ICLAMP calibration.

1. Ensure the rotary selector switch is in the **OFF** position.
2. Connect the instrument as shown in Figure 30.

Figure 30: instrument connection for measuring ground current

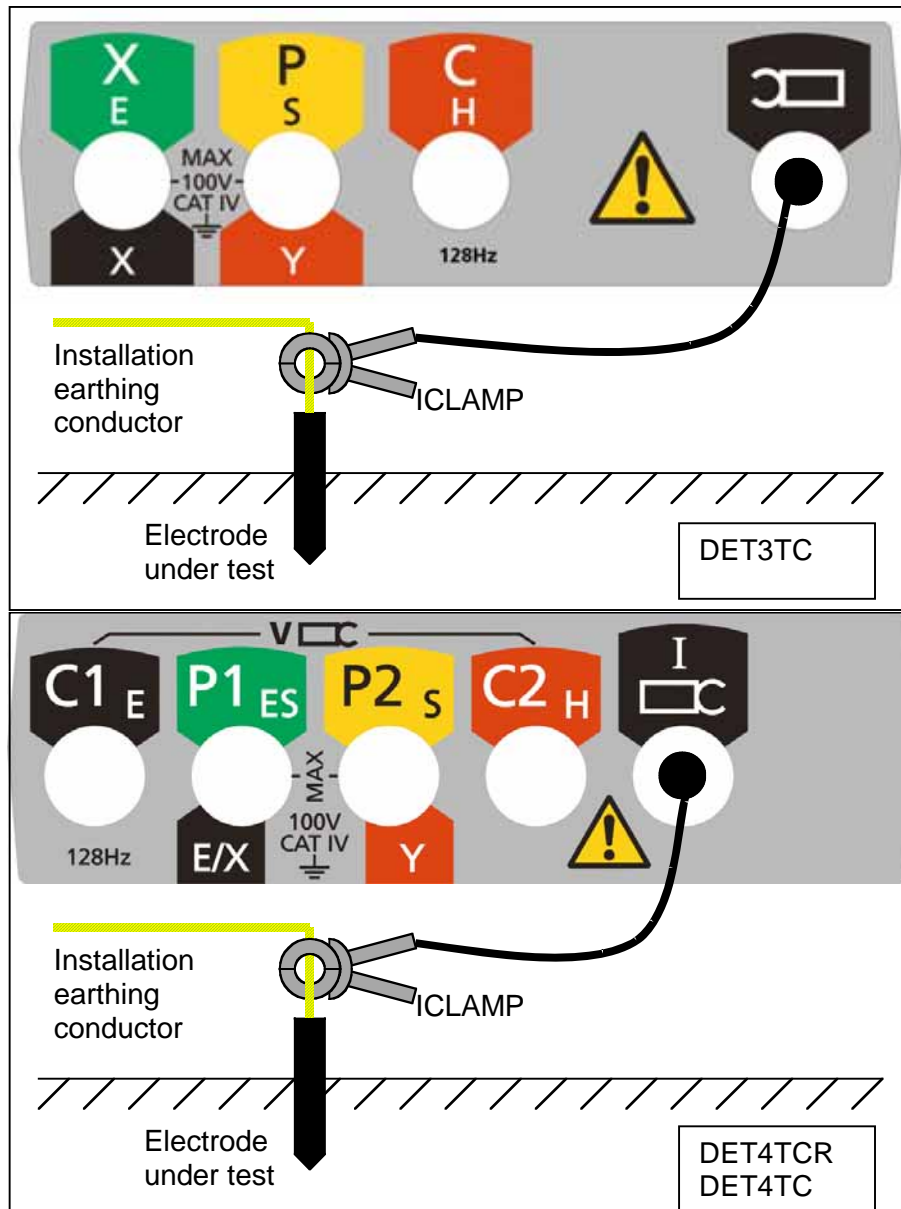

3. Close the ICLAMP around the conductor under test.
4. Set the rotary selector switch to the **A** position.
5. The ground current flowing in the conductor will be displayed as shown in Figure 31.

Figure 31: example ground current reading (DET4TC / DET4TCR display shown)

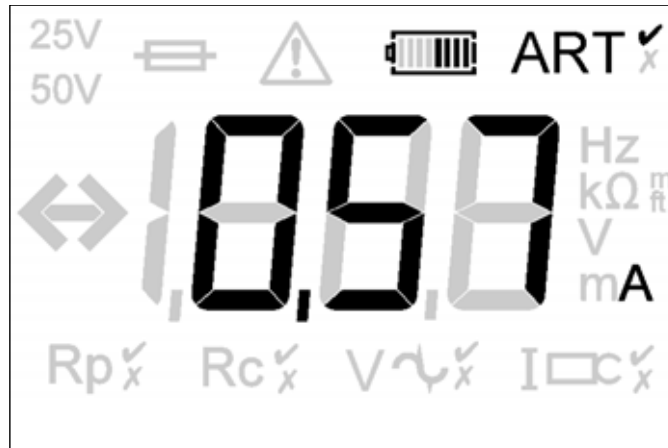

Note:

- The instrument will display the warning triangle above 2 A – no ART testing is possible under this condition.
- The instrument will display the warning triangle and an over-range condition above 20 A – no ART testing is possible under this condition.

Three-terminal resistance measurement using ART (DET3TC, DET4TC and DET4TCR)

Before making a measurement using ART, please follow the procedure contained in the section on ICLAMP calibration.

1. Ensure the rotary selector switch is in the **OFF** position.
2. Connect the instrument as shown in Figure 32.

Figure 32: instrument connection for measuring three-terminal resistance using ART

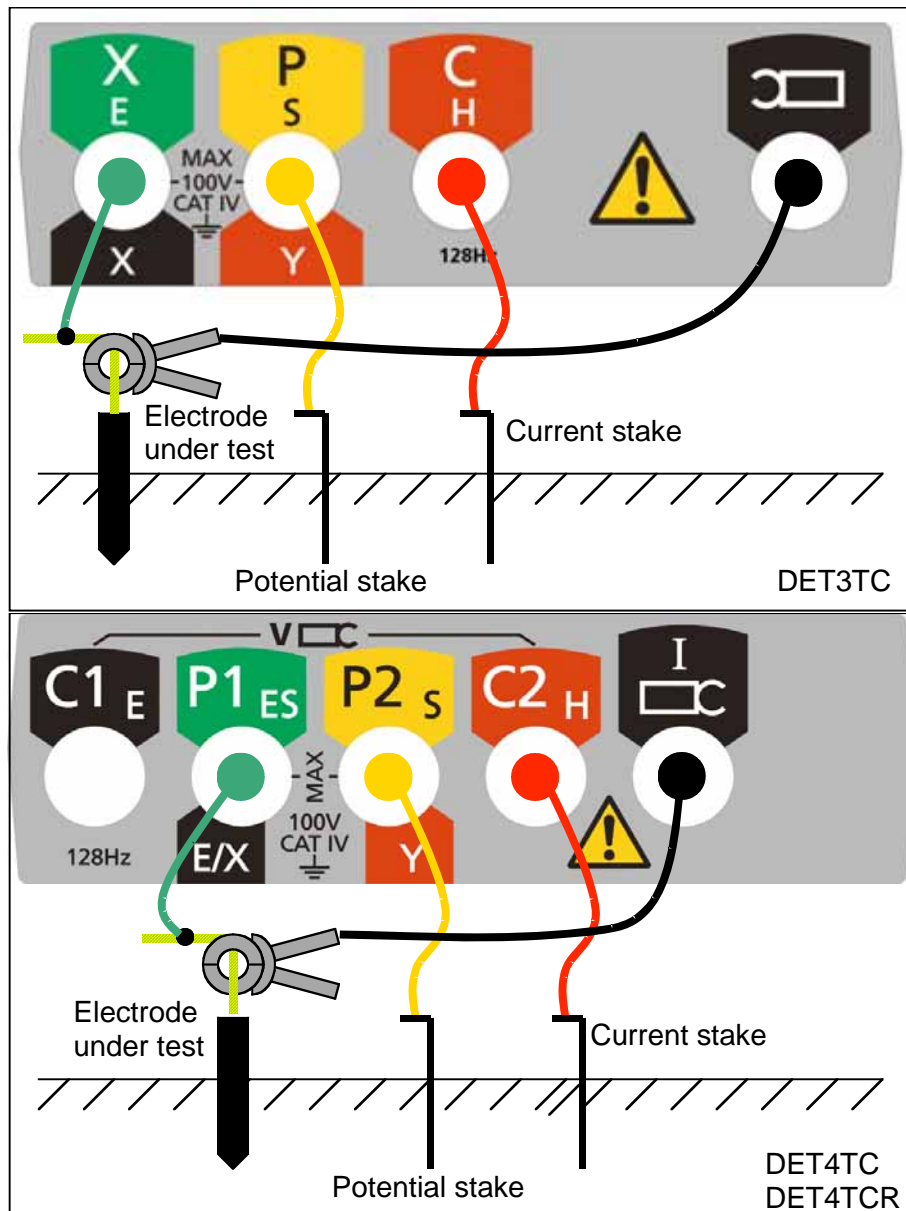

3. Close the ICLAMP around the conductor under test.
4. Set the rotary selector switch to the **3P**  position.
5. Press and release the **TEST** button [by holding the **TEST** button, the resistance measurement will be continually updated].

6. The instrument will perform pre-measurement checks, the status of which will be indicated on the display.
7. The three-terminal resistance reading using ART will be displayed as shown in Figure 33.

Figure 33: example three-terminal resistance reading using ART (DET4TC / DET4TCR display shown)

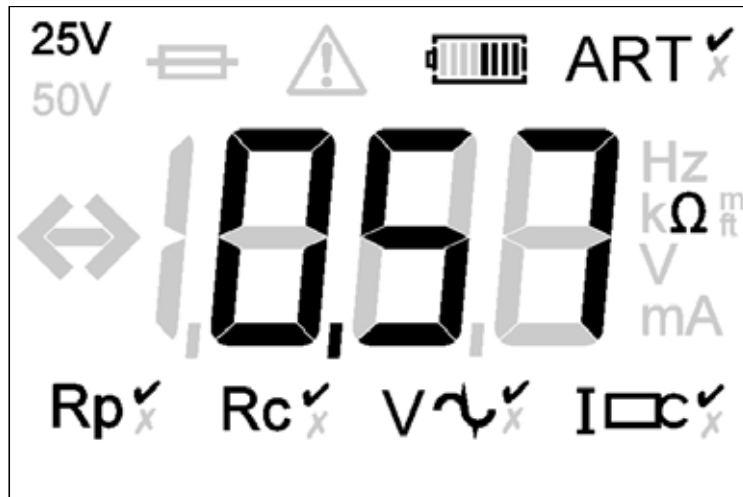

8. Under certain circumstances, the instrument may display a noise warning as shown:

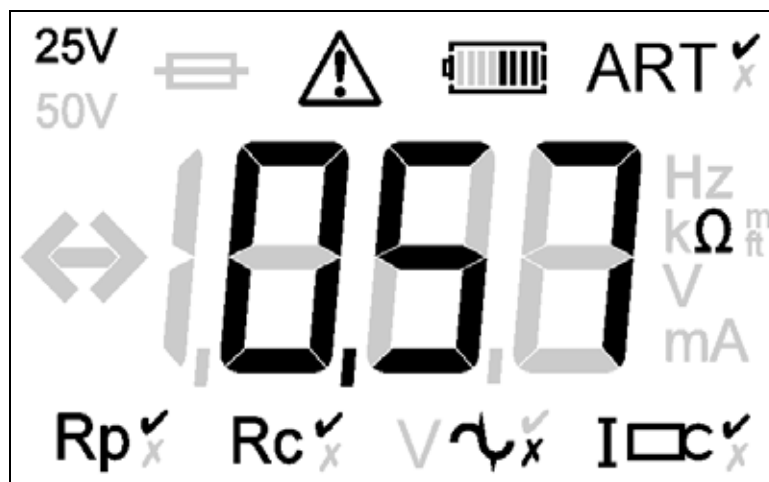

This means that interference has been detected which may impair the accuracy of the measurement. In particular, the reading could be lower than the actual resistance. The resistance of the electrode or system must be verified by an alternative method.

Note:

- The instrument will display the warning triangle and an excessive noise voltage indicator if the ground noise voltage is above 40 V pk-pk (14 Vrms).
- The instrument will display the warning triangle and a voltage over-range condition if the ground noise voltage is above 100 V – no resistance reading is possible under this condition.
- The instrument will display the warning triangle above 2 A – no ART testing is possible under this condition.

- The instrument will display the warning triangle and an over-range condition above 20 A – no ART testing is possible under this condition.
- Ensure that the ICLAMP jaw mating surfaces are free of dust and contamination and that they contact completely when the ICLAMP is closed.
- Currents carried by conductors in close proximity to the ICLAMP may affect calibration and reduce the accuracy of measurements made.

Three-terminal resistance measurement with lead-null using ART (DET4TC and DET4TCR)

In certain circumstances, the resistance of the test leads connecting to the electrode under test may itself form a significant part of the measurement electrode resistance. This effect can be eliminated using the lead-null technique described in this section.

Before making a measurement using ART, please follow the procedure contained in the section on ICLAMP calibration.

1. Ensure the rotary selector switch is in the **OFF** position.
2. Connect the instrument as shown in Figure 34.

Figure 34: instrument connection for measuring three-terminal resistance with lead-null using ART

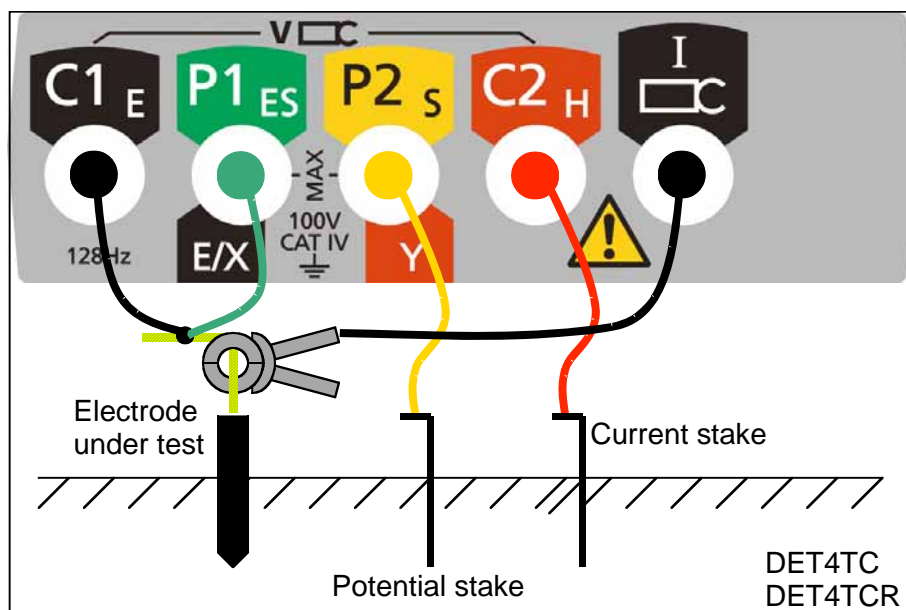

3. Close the ICLAMP around the conductor under test.
4. Set the rotary selector switch to the **4P**  position.
5. Press and release the **TEST** button [by holding the **TEST** button, the resistance measurement will be continually updated].
6. The instrument will perform pre-measurement checks, the status of which will be indicated on the display.
7. The three-terminal resistance reading with lead-null using ART will be displayed as shown in Figure 35.

Figure 35: example three-terminal resistance reading with lead-null using ART (DET4TC / DET4TCR display shown)



8. Under certain circumstances, the instrument may display a noise warning as shown:

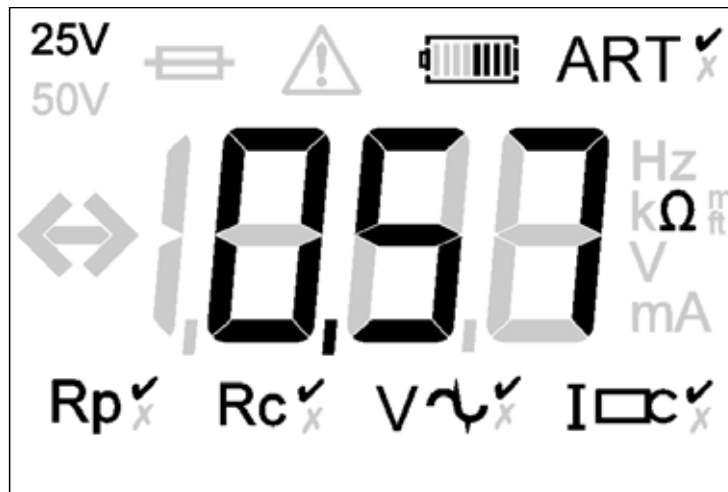
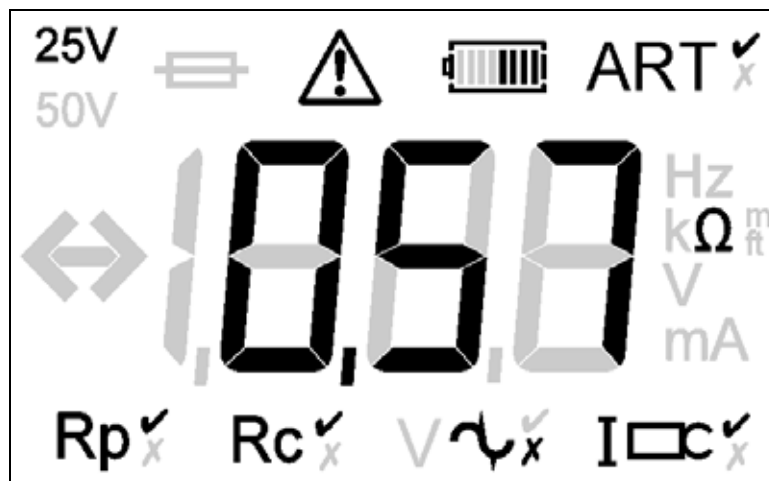

This means that interference has been detected which may impair the accuracy of the measurement. In particular, the reading could be lower than the actual resistance. The resistance of the electrode or system must be verified by an alternative method.

Note:

- The instrument will display the warning triangle and an excessive noise voltage indicator if the ground noise voltage is above 40 V pk-pk (14 Vrms).
- The instrument will display the warning triangle and a voltage over-range condition if the ground noise voltage is above 100 V – no resistance reading is possible under this condition.
- The instrument will display the warning triangle above 2 A – no ART testing is possible under this condition.
- The instrument will display the warning triangle and an over-range condition above 20 A – no ART testing is possible under this condition.
- Ensure that the ICLAMP jaw mating surfaces are free of dust and contamination and that they contact completely when the ICLAMP is closed.
- Currents carried by conductors in close proximity to the ICLAMP may affect calibration and reduce the accuracy of measurements made.

Two-clamp stakeless measurement (DET4TC and DET4TCR)

Before making a stakeless measurement, please follow the procedures contained in the sections on ICLAMP calibration.

1. Ensure the rotary selector switch is in the **OFF** position.
2. Connect the instrument as shown in Figure 36.

Figure 36: instrument connection for two-clamp stakeless measurement

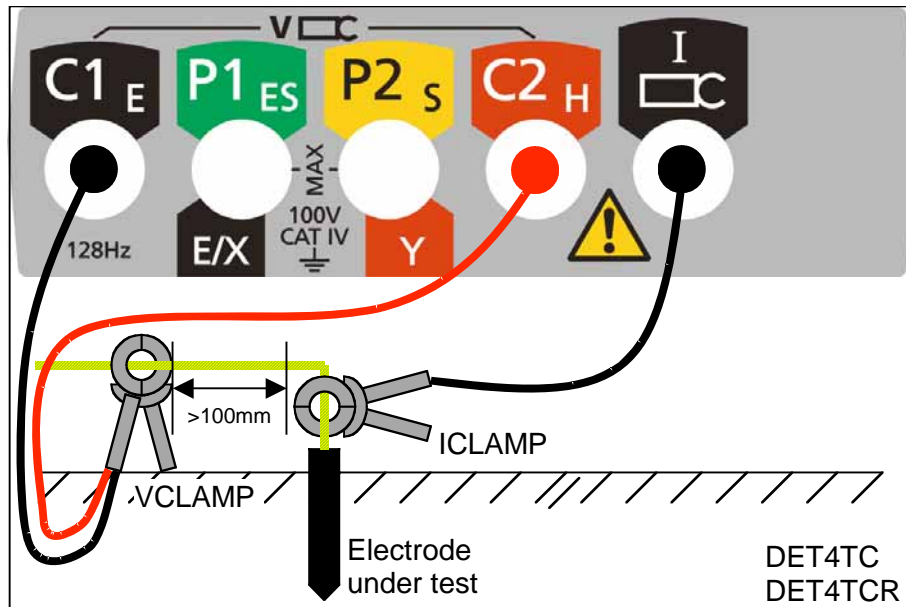

3. Close the ICLAMP around the conductor under test. Ensure the arrow on the side of the jaw is pointing in the same direction as the arrow on the VCLAMP.
4. Close the VCLAMP around the conductor under test. Ensure the arrow on the side of the jaw is pointing in the same direction as the arrow on the ICLAMP.
5. Ensure a minimum separation of 100mm between the ICLAMP and VCLAMP.
6. Set the rotary selector switch to the  position.
7. Press and release the **TEST** button [by holding the **TEST** button, the resistance measurement will be continually updated].
8. The instrument will perform pre-measurement checks, the status of which will be indicated on the display.
9. The stakeless resistance reading will be displayed as shown in Figure 37.

Figure 37: example resistance reading using two-clamp stakeless method



10. Under certain circumstances, the instrument may display a noise warning as shown:

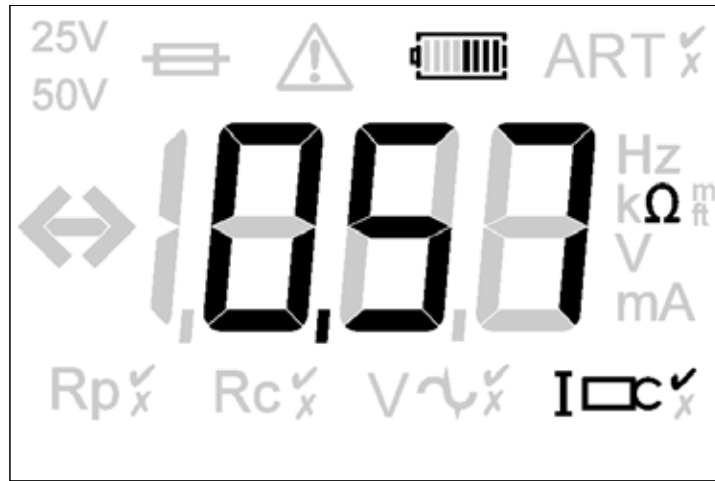
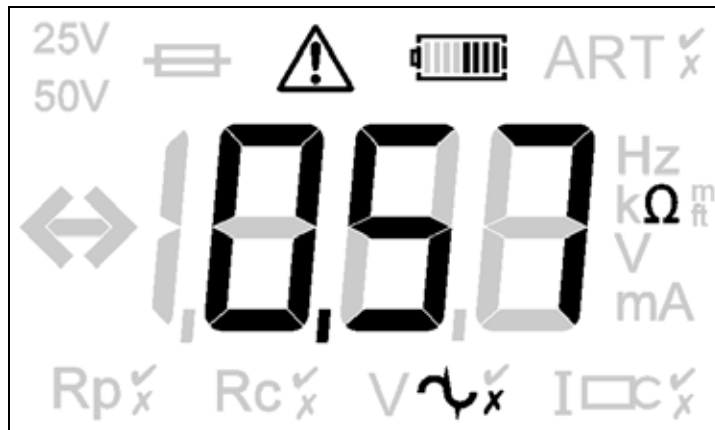

This means that interference has been detected which may impair the accuracy of the measurement. In particular, the reading could be lower than the actual resistance. The resistance of the electrode or system must be verified by an alternative method.

Note:

- The instrument will display the warning triangle above 2 A – no “Stakeless” testing is possible under this condition.
- The instrument will display the warning triangle and an over-range condition above 20 A – no “Stakeless” testing is possible under this condition.
- Ensure that the VCLAMP and ICLAMP jaw mating surfaces are free of dust and contamination and that they contact completely when the VCLAMP and ICLAMP are closed.
- Currents carried by conductors in close proximity to the VCLAMP and ICLAMP may affect calibration and reduce the accuracy of measurements made.
- If the VCLAMP opens at any time after the **TEST** button is pressed, the test will be aborted.

ICLAMP calibration (DET3TC, DET4TC and DET4TCR)

The ICLAMP should be calibrated once at each test site to take into account the effects of transportation, temperature and humidity on the ICLAMP.

1. Ensure the rotary selector switch is in the **OFF** position.
2. Connect the instrument as shown in Figure 38.
3. Ensure that the ICLAMP is not clamped around a conductor.
4. Press and hold the **TEST** button and switch instrument ON to the **A** setting using the selector switch.
5. Release the **TEST** button.

Figure 38: ICLAMP zero calibration

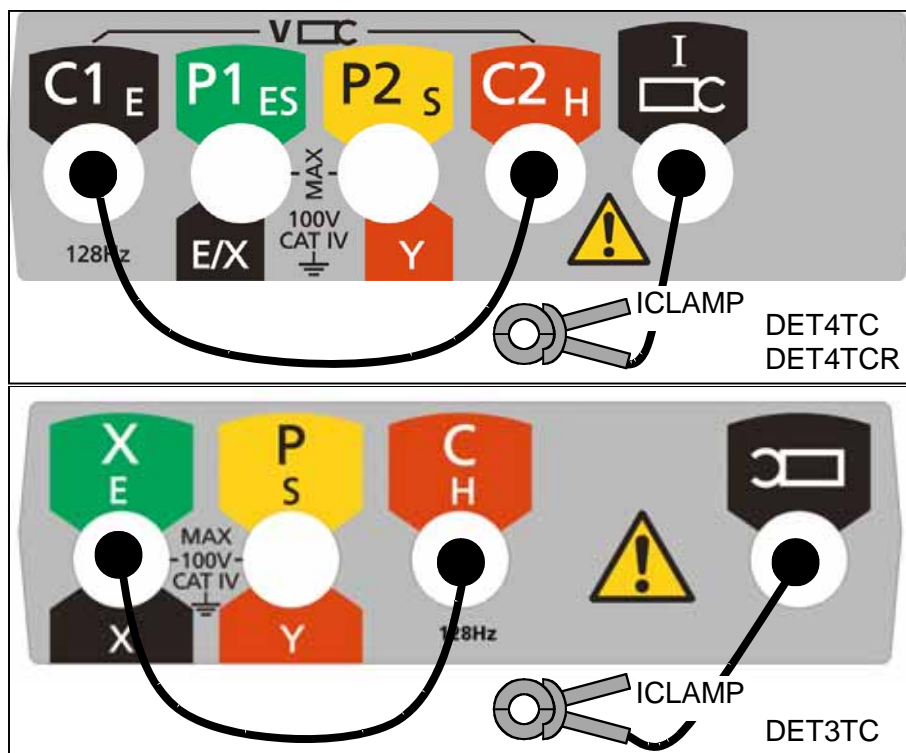

6. Press and hold the **TEST** button until a “0” reading is obtained on the display.
7. Connect the **C1** and **C2** terminals together using the calibration lead supplied with the ICLAMP. [X and C terminals for DET3TC]
8. Close the ICLAMP around the calibration lead, which connects the **C1** and **C2** terminals as shown in Figure 39. [X and C terminals for DET3TC]

Figure 39: ICLAMP 100% calibration

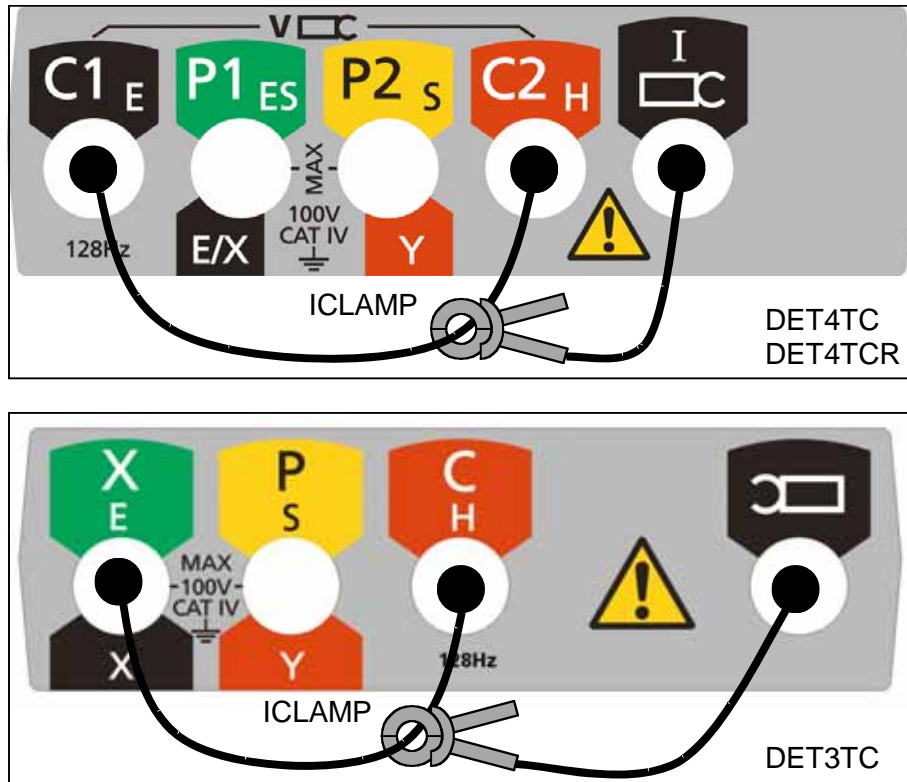



9. Press and hold the **TEST** button until a “100” reading is obtained on the display.
10. Switch the instrument **OFF** using the selector switch.
11. The instrument is now calibrated to the ICLAMP and the calibration stored in non-volatile memory.

OPERATION OF THE TWO-CLAMP CALIBRATION ADAPTOR

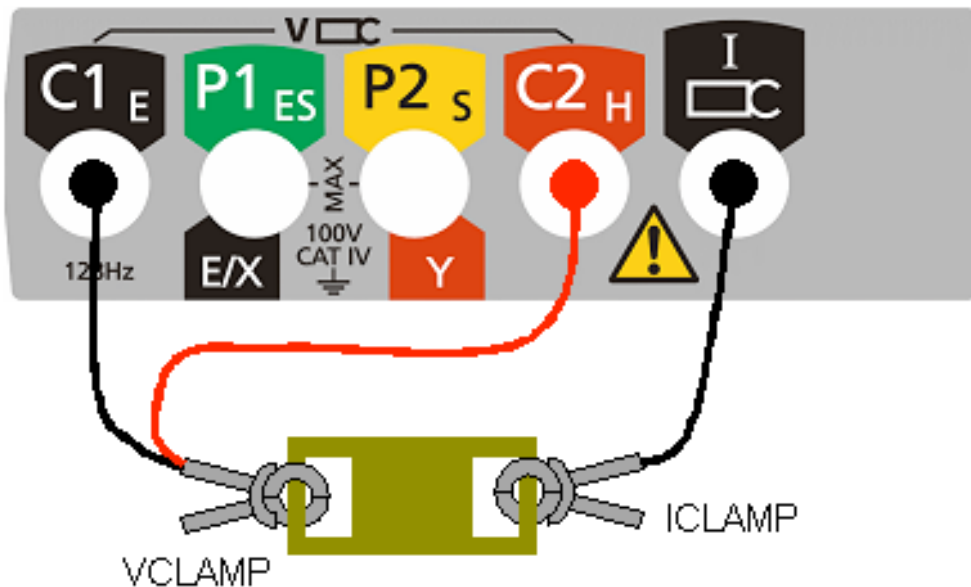
1. Ensure the rotary selector switch is in the **OFF** position.
2. Connect the instrument as shown.



3. Close the ICLAMP around one loop of the two-clamp calibration adaptor.
4. Close the VCLAMP around the other loop of the two-clamp calibration adaptor.
5. Ensure a minimum separation of 100mm between the ICLAMP and VCLAMP.
6. Set the rotary selector switch to the  position.

7. Press and release the **TEST** button [by holding the **TEST** button, the resistance measurement will be continually updated].
8. The instrument will perform pre-measurement checks, the status of which will be indicated on the display.
9. The two-clamp resistance reading will be displayed and should match the value written on the two-clamp calibration adaptor.

Note:

1. Ensure that the ICLAMP and VCLAMP jaw mating surfaces are free of dust and contamination and that they contact completely when the units are closed.

2. Currents carried by conductors in close proximity to the ICLAMP may affect calibration and reduce the accuracy of measurements made.

OPERATION OF THE CALIBRATION ADAPTOR

1. Ensure the rotary selector switch is in the **OFF** position.
2. Connect the instrument as shown.

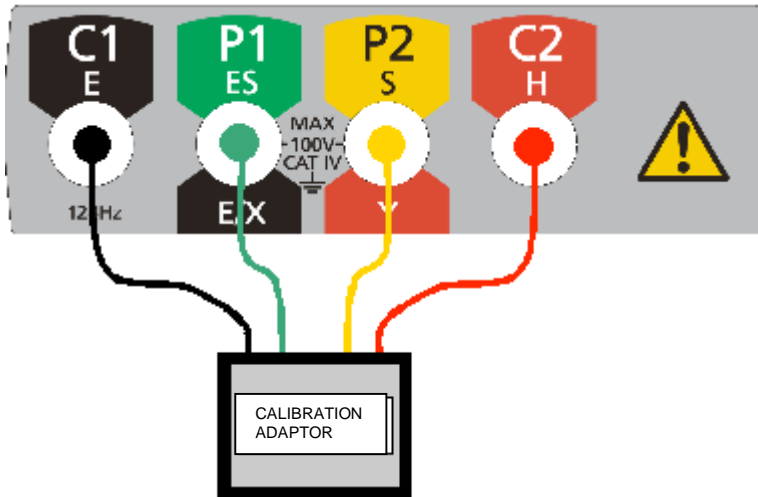

3. Set the rotary selector switch to the **2P**, **3P** or **4P** position.
4. Press and release the **TEST** button [by holding the **TEST** button, the resistance measurement will be continually updated].
5. The instrument will perform pre-measurement checks, the status of which will be indicated on the display.
6. The resistance reading will be displayed and should match the value written on the calibration adaptor.

PREVENTIVE INSTRUMENT MAINTENANCE

1. The DET series instruments require very little maintenance.
2. Test leads should be checked before use to ensure there is no damage.
3. Ensure batteries are removed if left unused for extended periods.
4. When necessary, the instrument can be cleaned with a damp cloth.
5. Do not use alcohol-based cleaners, as these may leave a residue.

TECHNICAL SPECIFICATION DET3Tx & DET4Tx

General Specification

Only values with tolerance or limits are guaranteed data. Parameters without tolerances are for information only.

Ingress protection:

IP54

C stake, P stake and Noise check:

Automatic

Noise rejection:

40 V pk to pk (14 V rms)

2-wire, 3-wire, 4-wire test:

Yes, no shorting links required

No disconnect testing (ART):

Yes, with ICLAMP

Stakeless measurement:

Yes, with ICLAMP and VCLAMP

Instrument output:

Voltage: ± 25 V or ± 50 V at 128Hz

Current:

4.5 mA or 0.4 5mA

Ground current range with clamp:

0.5 mA to 19.9 A

Ground current accuracy:

5% ± 3 digits

Ground voltage range:

0 to 100 Vac

Ground voltage accuracy:

2% ± 2 V

Resistance range:

0.01 Ω to 20 k Ω (DET4TC and DET4TCR)

0.01 Ω to 2 k Ω (all other DET's)

Resistance accuracy:

2P measurements: 2% ± 3 digits

3P measurements: 2% ± 3 digits

4P measurements: 2% ± 3 digits

ART measurements: 5% ± 3 digits

Stakeless measurements: 7% ± 3 digits

Maximum probe resistance:

Rp limit: 100 k Ω (5 0 V output voltage)

Rc limit: 100 k Ω (50 V output voltage)

Limits reduced to 50 k Ω for 25 V output voltage

Limits reduced to 5 k Ω for 0.01 Ω resolution

Display:

3½ digit high contrast liquid crystal, backlit

Battery type:

DET4TC - 8 off AA (LR6) dry cells

DET4TCR – 8 off AA (LR6) NiMH rechargeable cells

Operating temperature range:

-15°C to +55°C / 5°F to 131°F

Storage temperature range:

-40°C to +70°C / -40°F to 158°F

Safety

Complies with the requirements of EN61010-1
100V CAT IV between terminal pairs.

EMC

In accordance with IEC61326 including
amendment No.1

Standards compliance

Complies with the requirements of KEMA K85B

Complies with the following parts of EN61557

Part 1 – General requirements

Part 5 – Resistance to earth

Dimensions:

203mm x 148mm x 78mm / 8in x 5.8in x 3in

Weight:

1 kg / 2.2 lb

ICLAMP SPECIFICATIONS

Measurement range: 1 mA to 1200 A
Transformation ratio: 1000 : 1
Output signal: 1 mA / A (1 A @ 1000 A)

Accuracy

1mA to 100 mA : $\leq 3\%$ of reading
0.1 A to 1 A : $\leq 2\%$ of reading
1 A to 10 A : $\leq 1\%$ of reading
10 A to 100 A : $\leq 0.5\%$ of reading

Operating temperature

-10°C to +50°C / 14°F to 122°F
0% to 85% RH at +35°C / 95°F

Storage temperature

-20°C to +70°C / -4°F to 158°F

Jaw opening: 57 mm maximum (2.3 in)
Maximum conductor size: 52 mm (2.1 in)
Insulation: Double insulation
Voltage rating: 600 V CAT III
Current rating: 1200 A for 20 minutes
Ingress protection: IP40

Safety

EN61010-2-032

EMC

EN 50081-1 Class B
EN 50082-2

Dimensions:

111 mm x 216 mm x 45 mm (4.4 in x 8.5 in x 1.8 in)

Weight: 0.5 kg approximately (1.2lb)

VCLAMP SPECIFICATIONS

Insulation: Double insulation
Voltage rating: 600V CAT III
Current rating: 1200A for 20 minutes
Ingress protection: IP40

Operating temperature

-10°C to +50°C / 14°F to 122°F
0% to 85% RH at +35°C / 95°F

Storage temperature

-20°C to +70°C / -4°F to 158°F

Jaw opening: 57mm maximum (2.3in)
Maximum conductor size: 52mm / 2.1in

Electrical safety

EN61010-2-032

EMC

EN 50081-1 Class B
EN 50082-2

Dimensions: 111mm x 216mm x 45mm
(4.4in x 8.5in x 1.8in)

Weight: 0.5 kg approximately (1.2 lb)

CALIBRATION ADAPTOR ELECTRICAL SPECIFICATION

Value: $25 \Omega \pm 0.1\%$

MECHANICAL SPECIFICATION

Operating temperature

-10°C to +50°C / 14°F to 122°F
0% to 85% RH at +35°C / 95°F

Storage temperature

-20°C to +70°C (-4°F to 158°F)

Dimensions: 60mm x 55mm x 25mm (2.5in x 2.25in x 1in)

Weight: 0.1 kg approximately (0.2 lb)

TWO-CLAMP CALIBRATION ADAPTOR ELECTRICAL SPECIFICATION

Value: $25 \Omega \pm 1\%$

MECHANICAL SPECIFICATION

Operating temperature

-10°C to +50°C (14°F to 122°F)
0% to 85% RH at +35°C / 95°F

Storage temperature

-20°C to +70°C (-4°F to 158°F)

Dimensions:

111mm x 216mm x 45mm (4.4in x 8.5in x 1.8in)

Weight:

0.1 kg approximately (0.2 lb)

REPAIR AND WARRANTY

The instrument contains static sensitive devices, and care must be taken in handling the printed circuit board. If an instrument's protection has been impaired it should not be used, but sent for repair by suitably trained and qualified personnel. The protection is likely to be impaired if for example, it shows visible damage, fails to perform the intended measurements, has been subjected to prolonged storage under unfavourable conditions, or has been subjected to severe transport stresses.

NEW INSTRUMENTS ARE GUARANTEED FOR 1 YEAR FROM THE DATE OF PURCHASE BY THE USER.

Note: Any unauthorized prior repair or adjustment will automatically invalidate the Warranty.

CALIBRATION, REPAIR AND SPARE PARTS

For service requirements for Megger Instruments contact:

Megger Limited	or	Megger
Archcliffe Road		Valley Forge Corporate Centre
Dover		2621 Van Buren Avenue
Kent CT17 9EN		Norristown PA 19403
England.		U.S.A.
Tel: +44 (0) 1304 502 243		Tel: +1 610 676 8579
Fax: +44 (0) 1304 207 342		Fax: +1 610 676 8625

Megger operate fully traceable calibration and repair facilities, ensuring your instrument continues to provide the high standard of performance and workmanship you expect. These facilities are complemented by a worldwide network of approved repair and calibration companies, which offer excellent in-service care for your Megger products.

Returning your product to Megger - UK and USA service centres

1. When an instrument requires recalibration, or in the event of a repair being necessary, a Returns Authorisation (RA) number must first be obtained from one of the addresses shown above. You will be asked to provide the following information to enable the Service Department to prepare in advance for receipt of your instrument, and to provide the best possible service to you.
 - Model, e.g. DET4TC.
 - Serial number, to be found on the underside of the case or on the calibration certificate.
 - Reason for return, e.g. calibration required, or repair.
 - Details of the fault if the instrument is to be repaired.
2. Make a note of the RA number. A returns label can be emailed or faxed to you if you wish.
3. Pack the instrument carefully to prevent damage in transit.
4. Ensure the returns label is attached, or that the RA number is clearly marked on the outside of the package and on any correspondence, before sending the instrument, freight paid, to Megger. Copies of the original purchase invoice and packing note should be sent simultaneously by airmail to expedite clearance through customs. In the case of instruments requiring repair outside the warranty period, an immediate quotation can be provided when obtaining the RA number.
5. You may track the progress of your return on line at www.megger.com

Approved Service Centres

A list of Approved Service Centres may be obtained from the UK address above, or from Megger's website at www.megger.com



Megger Limited
Archcliffe Road, Dover
Kent CT17 9EN England
T +44 (0)1 304 502101
F +44 (0)1 304 207342
E uksales@megger.com

Megger
4271 Bronze Way, Dallas,
Texas 75237-1019 USA
T +1 800 723 2861 (USA ONLY)
T +1 214 333 3201
F +1 214 331 7399
E ussales@megger.com

Megger
Z.A. Du Buisson de la Couldre
23 rue Eugène Henaff
78190 TRAPPES France
T +33 (0)1 30.16.08.90
F +33 (0)1 34.61.23.77
E infos@megger.com

Megger Pty Limited
Unit 26 9 Hudson Avenue
Castle Hill
Sydney NSW 2125 Australia
T +61 (0)2 9659 2005
F +61 (0)2 9659 2201
E ausales@megger.com

Megger Limited
110 Milner Avenue Unit 1
Scarborough Ontario M1S 3R2
Canada
T +1 416 298 9688 (Canada only)
T +1 416 298 6770
F +1 416 298 0848
E casales@megger.com

Megger products are distributed in 146 countries worldwide.

**This instrument is manufactured in the United Kingdom.
The company reserves the right to change the specification or design without prior notice.**

Megger is a registered trademark

Part No. DET4TC_UG_en_V02 0207

www.megger.com