



## **digiPHONE+2** **digiPHONE+2 NT** **digiPHONE+2 NTRX**

### **USER GUIDE**

Issue: E (06/2025) - EN  
Article number: 87047





## Consultation with Megger

The present system manual has been designed as an operating guide and for reference. It is meant to answer your questions and solve your problems in as fast and easy a way as possible. Please start with referring to this manual should any trouble occur.

In doing so, make use of the table of contents and read the relevant paragraph with great attention. Furthermore, check all terminals and connections of the instruments involved.

Should any question remain unanswered or should you need the help of an authorized service station, please contact:

Megger Limited  
Archcliffe Road  
Kent CT17 9EN  
T: +44 1304 502100  
F: +44 1304 207342  
E: [uksales@megger.com](mailto:uksales@megger.com)

Megger Germany GmbH (Baunach)  
Dr.-Herbert-lann-Str. 6  
D - 96148 Baunach  
T: +49 9544 68 – 0  
F: +49 9544 22 73  
E: [team.dach@megger.com](mailto:team.dach@megger.com)

Megger Germany GmbH (Radeburg)  
Röderau 41  
D - 01471 Radeburg / Dresden  
T: +49 35208 84 – 0  
F: +49 35208 84 249  
E: [team.dach@megger.com](mailto:team.dach@megger.com)

Megger USA  
Valley Forge Corporate Centre  
2621 Van Buren Avenue  
Norristown, PA 19403 USA  
T: +1 610 676 8500  
F: +1 610 676 8610

© Megger

All rights reserved. No part of this handbook may be copied by photographic or other means unless Megger have before-hand declared their consent in writing. The information in this document is subject to change without notice and should not be construed as a commitment by Megger. Megger cannot be made liable for technical or printing errors or shortcomings of this handbook. Megger also disclaims all responsibility for damage resulting directly or indirectly from the delivery, supply, or use of this matter.

## **Terms of Warranty**

Megger accept responsibility for a claim under warranty brought forward by a customer for a product sold by Megger under the terms stated below.

Megger warrant that at the time of delivery Megger products are free from manufacturing or material defects which might considerably reduce their value or usability. This warranty does not apply to faults in the software supplied. During the period of warranty, Megger agree to repair faulty parts or replace them with new parts or parts as new (with the same usability and life as new parts) according to their choice.

This warranty does not cover wear parts, lamps, fuses, batteries and accumulators.

Megger reject all further claims under warranty, in particular those from consequential damage. Each component and product replaced in accordance with this warranty becomes the property of Megger.

All warranty claims versus Megger are hereby limited to a period of 12 months from the date of delivery. Each component supplied by Megger within the context of warranty will also be covered by this warranty for the remaining period of time but for 90 days at least.

Each measure to remedy a claim under warranty shall exclusively be carried out by Megger or an authorized service station.

This warranty does not apply to any fault or damage caused by exposing a product to conditions not in accordance with this specification, by storing, transporting, or using it improperly, or having it serviced or installed by a workshop not authorized by Megger. All responsibility is disclaimed for damage due to wear, will of God, or connection to foreign components.

For damage resulting from a violation of their duty to repair or re-supply items, Megger can be made liable only in case of severe negligence or intention. Any liability for slight negligence is disclaimed.

Since some states do not allow the exclusion or limitation of an implied warranty or of consequential damage, the limitations of liability described above perhaps may not apply to you.

**Contents**

**Consultation with Megger .....3**

**Terms of Warranty .....4**

**Contents .....5**

**1 Basic notes .....7**

**2 Technical description .....9**

2.1 System description .....9

2.2 Technical data .....13

2.3 Connections and controls on the indicator unit .....16

**3 Basic operation of the indicator unit.....17**

**4 Pinpointing Cable Faults in “Digiphone” Mode  .....19**

4.1 Preparatory Measures .....19

4.1.1 Starting Up the Surge Wave Generator .....19

4.1.2 Preparing the Sensor .....20

4.1.3 Connecting the Sensor and Headphones to the Indicator Unit.....22

4.2 General information on operation .....23

4.2.1 Adjusting the Settings.....24

4.2.1.1 Adjusting the Basic Settings.....25

4.2.1.2 Adjusting the Measurement Settings .....27

4.3 General information on locating faults with the device.....29

4.3.1 Interpreting the measured value and direction data .....29

4.3.2 Volume Settings .....31

4.3.3 Switching between automatic and manual trigger sensitivity setting .....33

4.4 Procedure for fault detection .....35

4.4.1 Tracing the Line.....35

4.4.2 Approaching the Fault .....36

4.5 Completing the Work.....39

**5 Line and probe location in “Ferrolux” mode  .....40**

5.1 Connecting the sensor and headphones to the display unit .....40

5.2 General information about operation.....41

5.2.1 Entering settings.....43

5.2.1.1 Entering basic settings .....44

5.2.1.2 Entering measurement settings .....46

5.2.2 Controlling sensitivity.....49

5.2.3 Recording and managing measurement series .....50

5.3 Line location and tracing using the iFS receiver .....52

5.3.1 Basics for using the iFS receiver.....52

5.3.2 Preparation .....53

5.3.3 Locating the line .....55



5.3.4	Clear identification of the line on the basis of the current flow direction (only possible with SignalSelect-modulated signal) .....	57
5.3.5	Depth measurement.....	59
5.3.6	Line tracing.....	62
5.3.7	Terrain examination.....	64
5.4	Locating probes .....	65
5.5	Locating faults and sleeves .....	68
5.5.1	Locating faults and sleeves using the minimum turbidity method.....	68
5.5.2	Locating faults and sleeves using the “Twisted-Field” method .....	69
5.6	Cable identification using the reader coil IFA (optional).....	71
5.7	Switching off the indicator unit .....	73
<b>6</b>	<b>Pinpointing Sheath Faults in „ESG“ Mode </b> .....	<b>74</b>
6.1	Preparatory Measures.....	74
6.1.1	Tracing the Line.....	74
6.1.2	Starting Up the DC Impulse Generator .....	74
6.1.3	Connecting the Earth Spikes.....	75
6.1.4	Turning On the Indicator Unit .....	77
6.1.5	Adjusting the Settings.....	79
6.1.5.1	Adjusting the Basic Settings.....	80
6.1.5.2	Adjusting the Measurement Settings .....	81
6.2	Approaching the Fault .....	83
6.2.1	General Notes .....	83
6.2.2	Procedure .....	85
6.3	Completing the Work.....	87
<b>7</b>	<b>Pairing with Bluetooth accessories .....</b>	<b>88</b>
<b>8</b>	<b>GPS data export and firmware update .....</b>	<b>91</b>
8.1	Exporting and deleting measurement series from the indicator unit.....	92
8.2	Updating the firmware .....	93
<b>9</b>	<b>Storage and Transport.....</b>	<b>94</b>
<b>10</b>	<b>Maintenance and Care .....</b>	<b>95</b>

# 1 Basic notes

**Safety precautions** This manual contains basic instructions for the initial use and operation of the device. For this reason, it is important to ensure that the manual is always available to authorised and trained operating personnel. Operating personnel should read the manual thoroughly. The manufacturer will not be held liable for any injury or damage to personnel or property through failure to observe the safety precautions contained in this manual.

The specific standards and regulations in each country must also be observed!

**Labelling of safety instructions** The following signal words and symbols are used in this manual and on the product itself:

Signal word / symbol	Description
<b>DANGER</b>	Indicates a potential hazard which <b>will result</b> in death or serious injury if not avoided.
<b>WARNING</b>	Indicates a potential hazard which <b>may result</b> in death or serious injury if not avoided.
<b>CAUTION</b>	Indicates a potential hazard which may result in moderate or minor injury if not avoided.
<b>NOTICE</b>	Indicates a potential hazard which may result in material damage if not avoided.
	Serves to highlight warnings and safety instructions. As a warning label on the product it is used to draw attention to potential hazards which have to be avoided by reading the manual.
	Serves to highlight warnings and safety instructions that explicitly indicate the risk of an electric shock.
	Serves to highlight important information and useful tips on the operation of the device/system. Failure to observe may lead to unusable measurement results.

**Working with products from Megger** It is important to observe the generally applicable electrical regulations of the country in which the device will be installed and operated, as well as the current national accident prevention regulations and internal company directives (work, operating and safety regulations).

Use genuine accessories to ensure system safety and reliable operation. The use of other parts is not permitted and invalidates the warranty.

**Operating staff** This system and its peripheral equipment may only be operated by trained or instructed operating personnel. Anyone else must be kept away.

The system may only be installed by a specialist electrician. DIN VDE 0104 (EN 50191), DIN VDE 0105 (EN 50110) and the German accident prevention regulations (UVV) define a specialist electrician as someone whose knowledge, experience and familiarity with the applicable regulations enables him to recognise potential hazards.

*Repair and maintenance* Repair and maintenance work may only be performed by Megger or authorised service partners. Megger recommends having the system tested and maintained at a Megger service centre once per annum.

Megger also offers its customers on-site service. Please contact your service centre as needed.

*Declaration of conformity (CE)* The system corresponds with the regulations of the following European directives:

**Directives:** EMC Directive (204/108/EC)

**Standards:** EMC

Technical safety

EN 55011, EN 61000-6-4 ,  
EN 61000-4-2, EN 61000-4-3,  
EN 61000-4-4, EN 61000-4-8

EN 61010-1, EN 50249, GPSG

*Use of third party software* This product contains protected software, which is licensed under the General Public License (GPL) and the Lesser General Public License (LGPL). This certifies your right to request the source code for these software components. You can find detailed information on the GPL/LGPL licenses under [www.gnu.org](http://www.gnu.org).

Images from the Icons8 library ([www.icons8.de](http://www.icons8.de)) are also used within the software.

*Used trademarks* The **Bluetooth<sup>®</sup>** word mark and logos are registered trademarks owned by Bluetooth SIG, Inc. and any use of such marks is under license.

*Disposal* Depending on where the device is used, the end user may be obliged by law (e.g. the German Electrical and Electronic Equipment Act (ElektroG)) to dispose of it separately from household waste.

Megger Germany GmbH as the manufacturer of the device undertakes to accept and properly dispose of the old device when a comparable new device is purchased.

If the old device is to be returned directly upon delivery of the new device, Megger Germany GmbH must be informed in advance if possible. Batteries and rechargeable batteries that can be removed from the old device must be handed in separately. The end user is responsible for deleting personal data from the old device.



The above points apply to all electrical and electronic equipment labelled with the adjacent symbol.

## 2 Technical description

### 2.1 System description

*Description* The indicator unit can be used for different measuring tasks depending on the measuring accessories connected. Which of the following sensors and antennas actually belong to the delivery (see page 9) depends on the set purchased:



#### **Surge wave receiver DPP-SU2 for the accurate pinpointing of flashover faults in buried cables**

A discharge generator feeds surge voltage pulses into the end of the faulty wire. These cause voltage arc-overs at the fault location. The resulting flashover noise propagates in the ground and is recorded with the surge wave receiver on the surface. The distance to the fault location can be calculated using either the volume of the flashover noise or the time difference between the arrival of the magnetic pulse and the flashover noise.



#### **Audio frequency receiver iFS for route tracing and fault location on buried metallic lines.**

With the aid of the antennas, the alternating current flowing in metallic lines can be recorded, converted into a signal and transferred to the indicator unit. In this way, as well as metallic lines which are transmitting a signal from a suitable transmitter (491 Hz ... 33 kHz), cables that are operational (50 / 60 Hz) and pipelines carrying a current of 100 Hz / 120 Hz current for protection from corrosion can be located and traced. For lines carrying an active signal generated by an audio frequency generator not only the path but also the laying depth, the current strength and the direction of signal flow (in case of a SignalSelect encoded signal) can be determined.



#### **Earth spikes for accurate pinpointing of sheath faults on plastic insulated PE and VPE medium voltage cables**

Sheath faults are pinpointed using the step voltage method. The measuring current flowing into the ground at the fault location forms a potential gradient forms at the point of escape, which is measured using earth spikes and the downstream indicator unit. The step voltage rises when both earth spikes are situated in front of the fault position. If the fault position is passed by, the step voltage polarity changes, which then subsides again the further away you go.



#### **Reader coil IFA for identifying a cable among several accessible cables (available as optional accessory only)**

As with the iFS receiver, the reader coil is used to detect audio frequency signals within the frequency range of 50 Hz to 33 kHz. In contrast to the receiver, the coil is applied directly onto the accessible cable, thus increasing the measurement accuracy. Thanks to SignalSelect compatibility, this method also ensures the reliable identification of a cable on which a SignalSelect signal is transmitted (e.g. when a cluster of cables is exposed after excavation work).

*Features* Depending on the connected measuring accessories, the indicator unit starts in different modes, which are characterized by the following features:

**Ferrolux mode** - 

- Different locating methods (minimum, maximum, super-maximum)
- Display of the path of the line
- Acoustic signal with TrueAudio
- Coded transmit signal (SignalSelect) for clear line identification
- Automatic depth and current measurement
- Measurement value and GPS data storage
- Locating of faults and joints using minimum turbidity

**Digiphone mode** - 

- Trend indicator
- Cable compass indicates the orientation of the line
- Outstanding acoustic qualities for quick and reliable fault location
- High level of accuracy due to selective recording of magnetic fields
- Very stable sensor
- Trigger thresholds for acoustic and magnetic channels set fully automatically
- Possibility to switch to manual trigger threshold adjustment
- Patented extraneous noise reduction
- Automatic proximity mute
- Volume limiter which can be switched on and off
- Height-adjustable telescopic handle for sensor
- Patented fault direction indicator (fault arrow)

**ESG mode** - 

- Automatic sensitivity adjustment to the voltage
- Patented, automatic zero point reference with elimination of DC voltage interference
- Automatic synchronization to generator speed
- Wide measurement range due to high level of sensitivity
- Suppression of interference (50/60 Hz, 16 $\frac{2}{3}$  Hz, 100/120 Hz)
- Alternative 50/60 Hz mode for pinpointing cable faults on live low-voltage cables.

*Included in delivery* Depending on the set purchased, the scope of delivery of the system includes at least the following components:

Component	digiPHONE+2	digiPHONE+2 NT	digiPHONE+2 NTRX	Item number
Indicator unit	●	●	●	1013268
<b>Digiphone sensor and accessories</b>				
DPP-SU sensor	●	●	●	1012815
Telescopic handle	●	●	●	2012701
Sensor cable	●	●	●	890026548
Base plate with bitumen	●	●	●	2012633
Base plate	●	●	●	899006924
Measuring rod 18 mm	●	●	●	118303027
Measuring rod 75 mm	●	●	●	890026252
3-point foot	●	●	●	118303026
<b>Earth spikes and accessories</b>				
2 earth spikes		●	●	128309680
Connection cable red, 2 m		●	●	128309356
Connection cable black, 2 m		●	●	128309357
Contact sponge		●	●	128308944
<b>Ferrolux receiver and accessories</b>				
iFS receiver			●	1010472
Receiver cable			●	90025743
<b>Headphones</b>				
Wired headphones	●			90026322
Bluetooth headphones		●	●	90044694
<b>Bags</b>				
Bag „Digiphone“	●			1013130
Bag „3in1“		●	●	1013131
<b>Other accessories</b>				
6 x AA batteries, type IEC R6 (alkaline manganese)	●	●	●	892334291
Manual	●	●	●	87047

*Check contents* Check the contents of the package for completeness and visible damage right after receipt. In the case of visible damage, the device must under no circumstances be taken into operation. If something is missing or damaged, please contact your local sales representative.

*Retrofitting of sensors* Missing sensors can be easily re-ordered via the following article numbers for the **digiPHONE+2** and **digiPHONE+2 NT** sets:

Sensor	Description	Item number
Ferrolux receiver unit incl. accessories	Consisting of sensor iFS, connection cable and transport bag.	1013132
ESG earth spikes incl. accessories	Consisting of 2 earth spikes, 2 connecting cables and transport bag. <b>Caution:</b> To retrofit this set, the indicator unit must be sent to the manufacturer.	1011722

*Optional accessories* The following optional accessories can also be ordered from Megger sales:

Accessory	Description	Item number
Identification antenna IFA	Mini antenna for cable identification	1011682
Wired headphones		90026322
Bluetooth headphones		90044694
GPS receiver set	Consisting of a Bluetooth-enabled GPS receiver and a connection cable for transmitting the GPS data	1013171
Connection cable for connection to a PC	Required to perform firmware updates or download GPS data from the indicator unit	118306713
Accumulator pack	Rechargeable battery pack with 2 Li-ion batteries (9V/650 mAh), suitable battery compartment and charger	2013006
Measuring spike for DPP-SU sensor, 130 mm	Measuring spike for use in very loose ground	899006926
Measuring spike for DPP-SU sensor, 300 mm	Measuring spike for use in extremely loose ground (e.g. sand)	890026254

## 2.2 Technical data

*Indicator unit* The indicator unit is defined by the following technical parameters:

Parameter	Value
<b>Power supply</b>	6 x AA batteries, type IEC R6 (alkaline manganese)
<b>Operating time</b>	>15 hours
<b>Voltmeter</b>	(Only with ESG mode enabled)
• Input resistance	650 kΩ
• Sensitivity	<5 μV
<b>Operating temperature</b>	-20 °C – 55 °C
<b>Operating humidity</b>	Max. relative humidity 93% at 30 °C
<b>Storage temperature</b>	-30 °C – 70 °C
<b>Display</b>	TFT colour display with 320 x 240 pixels
<b>Headphone connection</b>	Via 3.5 mm jack socket or Bluetooth interface
<b>Weight</b>	<0.9 kg
<b>Dimensions</b>	225 mm x 65 mm x 100 mm (W x H x D)
<b>IP protection class</b> (in accordance with IEC 60529 (DIN VDE 0470-1))	IP 54

*DPP-SU sensor* The DPP-SU sensor is defined by the following parameters:

Parameter	Value
<b>Acoustic amplification</b>	>120 dB (facility for limiting amplification to 84 dB(A) can be switched on and off)
<b>Dynamic range</b>	
• Acoustic channel	>110 dB
• Magnetic channel	>110 dB
<b>Acoustic frequency range</b>	100 to 1500 Hz
<b>Acoustic filters</b>	Software-activated filters for improving acoustic perception
<b>Noise suppression</b>	Patented noise suppression (BNR) (software-activated)
<b>Automatic mute</b>	Proximity sensor for automatic mute
<b>Trigger threshold setting</b>	Can be switched between automatic and manual setting
<b>Error direction detection</b>	Automatic
<b>Weight</b> (incl. telescopic handle)	<2.2 kg
<b>Dimensions</b>	230 mm x 140 mm (Ø x H)
<b>IP protection class</b> (in accordance with IEC 60529 (DIN VDE 0470-1))	IP 65 (only for plugged-in connector)

*Receiver iFS* The iFS receiver is defined by the following parameters:

Parameter	Value
<b>Reception frequencies</b> <ul style="list-style-type: none"> <li>• Passive</li> <li>• Active</li> </ul>	50 Hz / 60 Hz / 100 Hz / 120 Hz / 15 ... 23 kHz 480 Hz / 491 Hz / 512 Hz / 640 Hz / 982 Hz / 1090 Hz / 1450 Hz / 8192 Hz / 8440 Hz / 9800 Hz / 9820 Hz / 32768 Hz
<b>Detectable current strength</b> <ul style="list-style-type: none"> <li>• 50 Hz</li> <li>• 491 Hz</li> <li>• 982 Hz</li> <li>• 8440 Hz</li> <li>• 32768 Hz</li> </ul>	At 1 m laying depth 10 mA ... 10,000 A 400 µA ... 400 A 180 µA ... 180 A 20 µA ... 20 A 5 µA ... 5 A
<b>Automatic depth measurement</b> <ul style="list-style-type: none"> <li>• Range</li> <li>• Accuracy</li> </ul>	(Except at passive frequencies of 15 ... 23 kHz) 0.1 ... 7 m (line location) 0.1 ... 15 m (probe location) ±5% up to 2 m depth (line) or 5 m depth (probe) resp.
<b>Manual depth measurement</b>	According to the 45° method
<b>Current strength measurement</b> <ul style="list-style-type: none"> <li>• Accuracy</li> </ul>	Only with active frequencies ±10%
<b>SignalSelect (current direction indication)</b>	Possible at all active frequencies (if supported by the transmitter)
<b>Weight</b> (incl. telescopic handle)	1.0 kg
<b>Dimensions</b>	100 mm x 730 mm x 45 mm (W x H x D)
<b>IP protection class</b> (in accordance with IEC 60529 (DIN VDE 0470-1))	IP 54

*ESG earth spikes* The earth spikes are defined by the following parameters:

Parameter	Value
<b>Weight</b>	750 g
<b>Length</b>	1.02 m

*Identification antenna IFA (optional)* The identification antenna is defined by the following parameters:

Parameter	Value
<b>Reception frequencies</b> <ul style="list-style-type: none"> <li>• Passive</li> <li>• Active</li> </ul>	50 Hz / 60 Hz / 100 Hz / 120 Hz / 15 ... 23 kHz 480 Hz / 491 Hz / 512 Hz / 640 Hz / 982 Hz / 1090 Hz / 1450 Hz / 8192 Hz / 8440 Hz / 9800 Hz / 9820 Hz / 32768 Hz
<b>Sensitivity</b> <ul style="list-style-type: none"> <li>• 50 Hz</li> <li>• 491 Hz</li> <li>• 982 Hz</li> <li>• 8440 Hz</li> <li>• 32768 Hz</li> </ul>	15 mA 1.5 mA 500 µA 50 µA 12 µA
<b>Dynamic range</b>	120 dB
<b>Weight</b>	180 g
<b>Dimensions</b> (without connection lead)	54 mm x 75 mm x 22 mm (W x H x D)
<b>IP protection class</b> (in accordance with IEC 60529 (DIN VDE 0470-1))	IP 54

### 2.3 Connections and controls on the indicator unit

The following illustration shows the connections and controls on the indicator unit:



Element	Description
1	Display
2	Knob
3	Function key 2
4	Earth spike connection sockets Maximum input voltage: 60 VDC/42 VAC <sub>peak</sub>
5	Sensor socket / receiver connection
6	Function key 1
7	Indicator unit on/off (when pressed and held), Backlighting on/off (when pressed briefly), LED indicates the device is switched on (green) and low batteries (red)
8	Connection socket for headphones

### 3 Basic operation of the indicator unit

*Switching on the indicator unit* Before switching on, the indicator unit must be connected to the measurement accessory that is required for the intended use. Then the indicator unit can be switched on by briefly pressing the button.

The connected measurement accessory is normally automatically detected and the appropriate software mode started immediately. The device is ready for operation after just a few seconds.

If the connected measurement accessory is not detected, a selection screen appears with the available software modes.

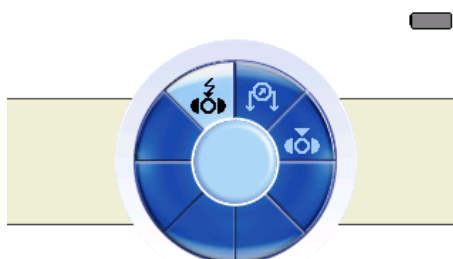

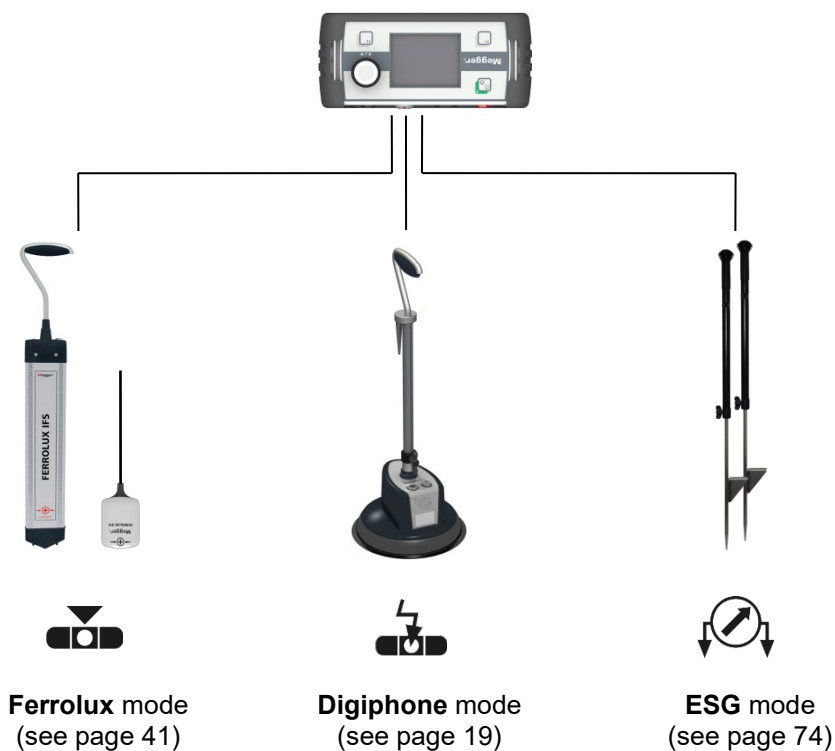

Once proper connection of the measurement accessory has been checked, the appropriate software mode can be selected manually. The displayed selection depends on the software modes that are enabled on the indicator unit:

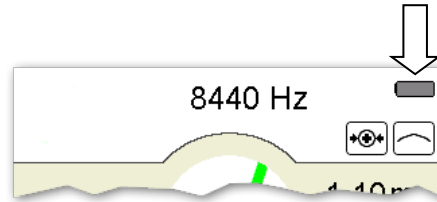

**Battery test** After switching on the device, you should check the battery status immediately using the charging bar in the top right corner of the display.







If the bar is barely filled, it is advisable to carry replacement batteries. As of a residual capacity of about 20%, both the battery status indicator and the LED in the  button illuminate in red.

**Back-light** The display backlighting is automatically activated immediately after the indicator unit is switched on. Because the indicator unit is equipped with a transreflective display, the background illumination must be switched off by **briefly pressing** the  push-button if sufficient strong sunlight is available. This extends the operating time of the indicator unit.

The backlight can be switched back on at any time by briefly pressing the button again.

**Operation using the knob** With the exception of a few functions, the indicator unit is operated exclusively using the knob. The functions available vary according to the respective current view:

Action	Function in the <u>measurement screen</u>	Function in the <u>menu screen</u>
	Opens the <u>menu screen</u>	Opens the currently selected menu item
	Adaptation of the measurement range and/or the volume (depending on the active mode)	Selects the menu item

**Function keys** The indicator unit is equipped with the two  and  function keys, which can be used to call up the important functions directly from the measurement screen without first having to call up the menu screen. The current function key assignments are permanently displayed in the bottom corners of the measurement screen.

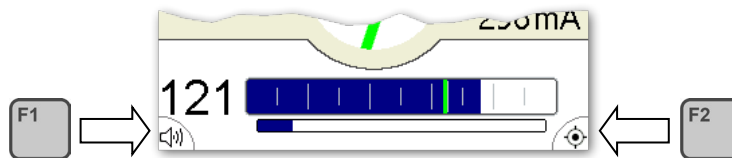

The function key assignments can be adapted in the basic settings of the respective software mode if necessary.

## 4 Pinpointing Cable Faults in "Digiphone" Mode

 <b>CAUTION</b>	If the volume limiter is deactivated, when listening to flashover noise, additional airborne sound and excessive amplification can lead to dangerous sound levels in the headphones!
---	--

### 4.1 Preparatory Measures

#### 4.1.1 Starting Up the Surge Wave Generator

 <b>WARNING</b>	To pinpoint a cable fault, a surge wave generator is needed. When equipment creating such high voltages is used, certain safety regulations must be complied with. It is essential to read the surge wave generator's manual before.
---	--

Connect the generator to the faulty wire and start applying surges with a surge voltage that will cause a flashover at the fault but which is also permitted for the cable type.

For more details about starting up the surge wave generator, please read the accompanying instructions.

---

---

	For effective background noise reduction (see page 37) a stable magnetic pulse is necessary. When the surge voltage is maximised, and with it the magnetic pulse level, this generally improves detection of the flashover noise.
---	---

---

---

## 4.1.2 Preparing the Sensor

*Fitting a suitable probe on the sensor* Three different probes are supplied with the sensor as standard (two sensor rods and one 3-point foot). They can be screwed onto the underside of the sensor to suit the ground conditions.

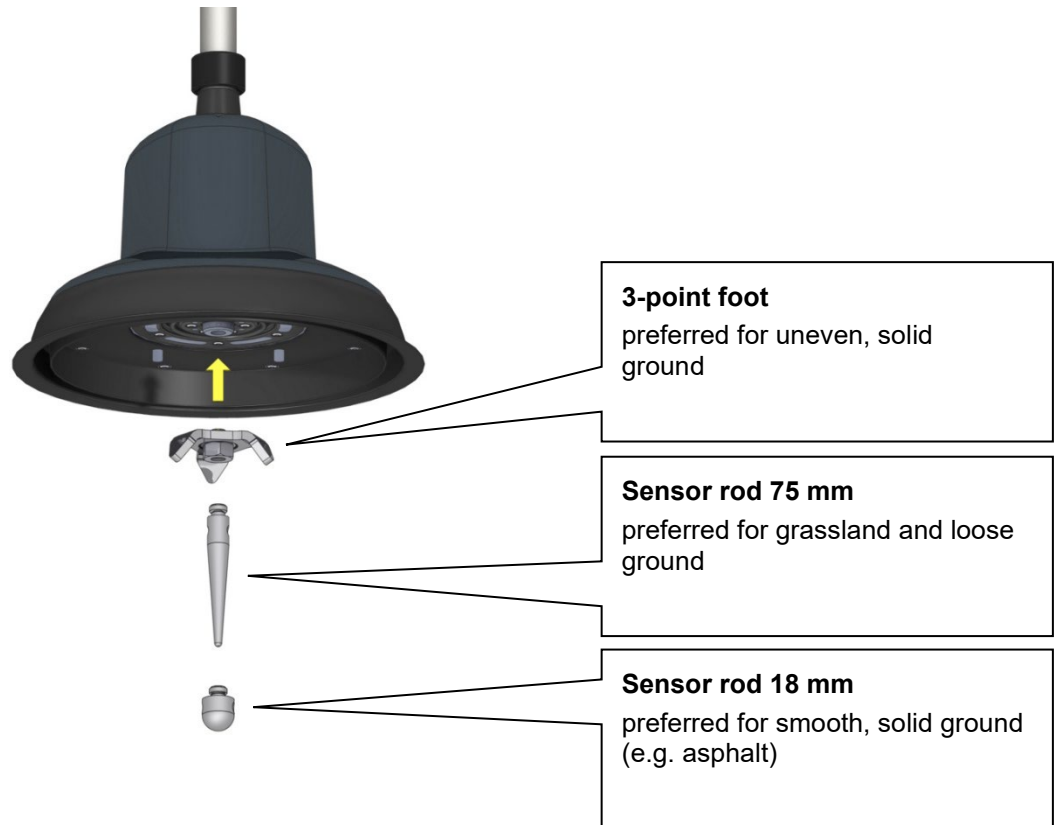

The 18 mm rod and the 3-point foot can both be used on smooth and solid ground. Because their acoustic qualities are different, it is for the operator to decide which probe they prefer to use on such ground.

An advantage of the 3-point foot is that a sensor rod can be fitted on its underside. This means that the foot does not need to be constantly unscrewed when the ground changes.



*Attaching / removing the telescopic handle* This is how to attach / remove the telescopic bar to / from the sensor:

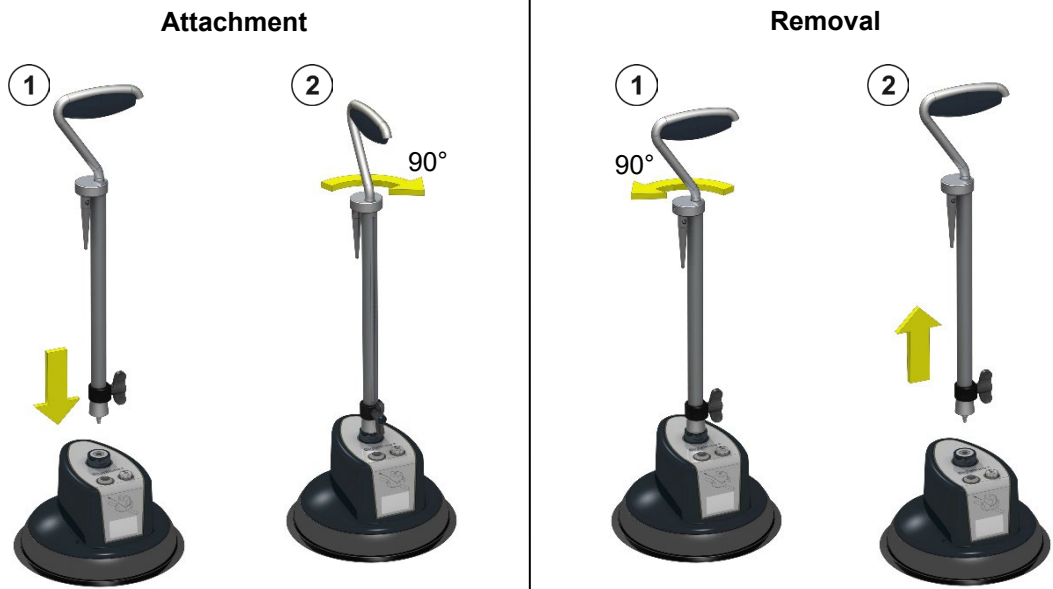

*Adjusting the height of the telescopic handle* This is how to adjust the height of the telescopic handle:

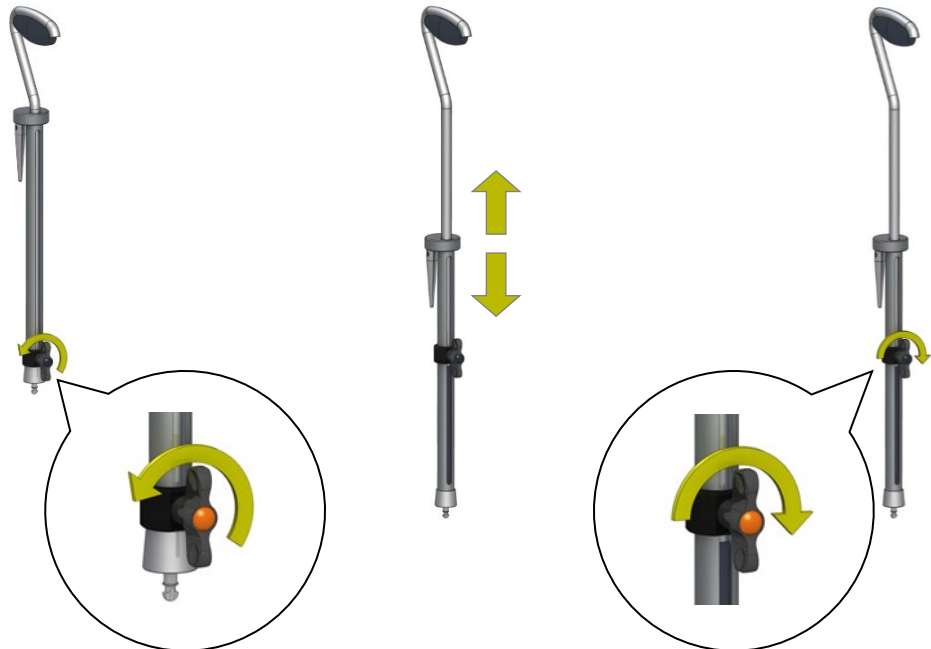

### 4.1.3 Connecting the Sensor and Headphones to the Indicator Unit

The coiled cable supplied is used to connect the sensor. Because the plug type and pin configuration match at both ends of the cable, you can choose any cable alignment. One end of the cable is connected to the socket ⑤ on the indicator unit and the other end to the socket on the top of the sensor (see illustration). The plug is aligned by the guides on the plug and the grooves on the socket. You must hear and feel the plug engage.

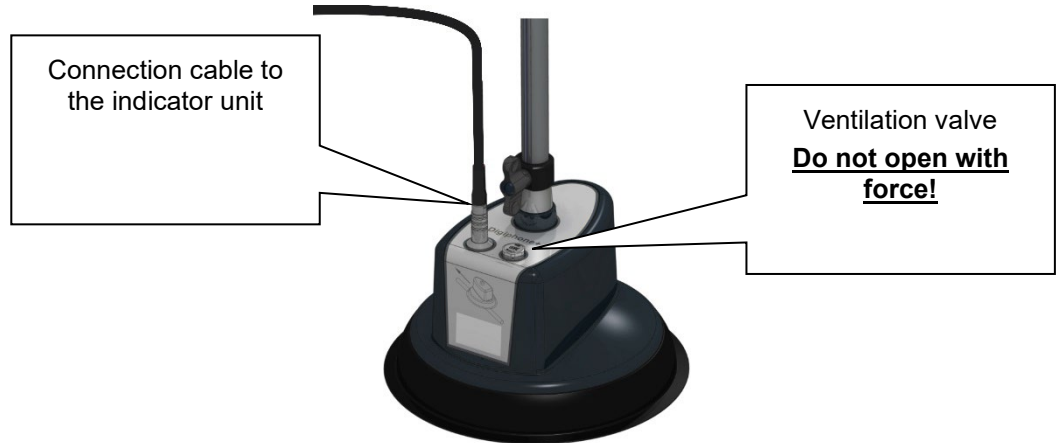

Depending on the headphones used, this is connected to the indicator unit via either a 3.5 mm jack socket ⑧ or Bluetooth (see page 88).

## 4.2 General information on operation

*Layout of the measurement screen* Shortly after switching on, the **measurement screen** appears. The device is now ready to measure.

In addition to the acoustic signal in the headphones, the **measurement screen** shows all relevant information that may be useful when approaching the cable fault during the pinpointing procedure:

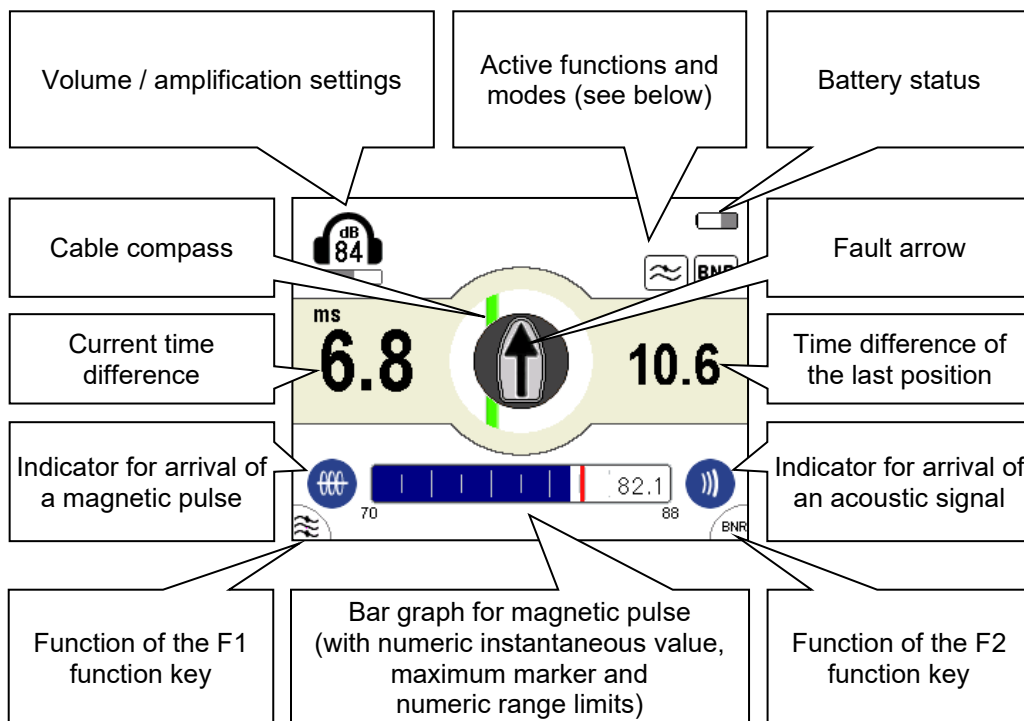

*Active functions and modes* The symbols at the top right of the measurement screen indicate the following functions and measurement modes:

Symbol	Beschreibung
	Noise suppression active (see page 27)
	Active filter setting (see page 27)
	Filter setting for short fault distances
	Filter setting for medium fault distances
	Filter setting for large fault distances
	Bluetooth status messages (see page 88)
	Scanning for visible devices
	Connecting to device
	Headset is connected
	GPS receiver connected

## 4.2.1 Adjusting the Settings

*Menu structure* You can switch from the **measurement screen** to the **menu screen** at any time and change any settings in two steps at most:

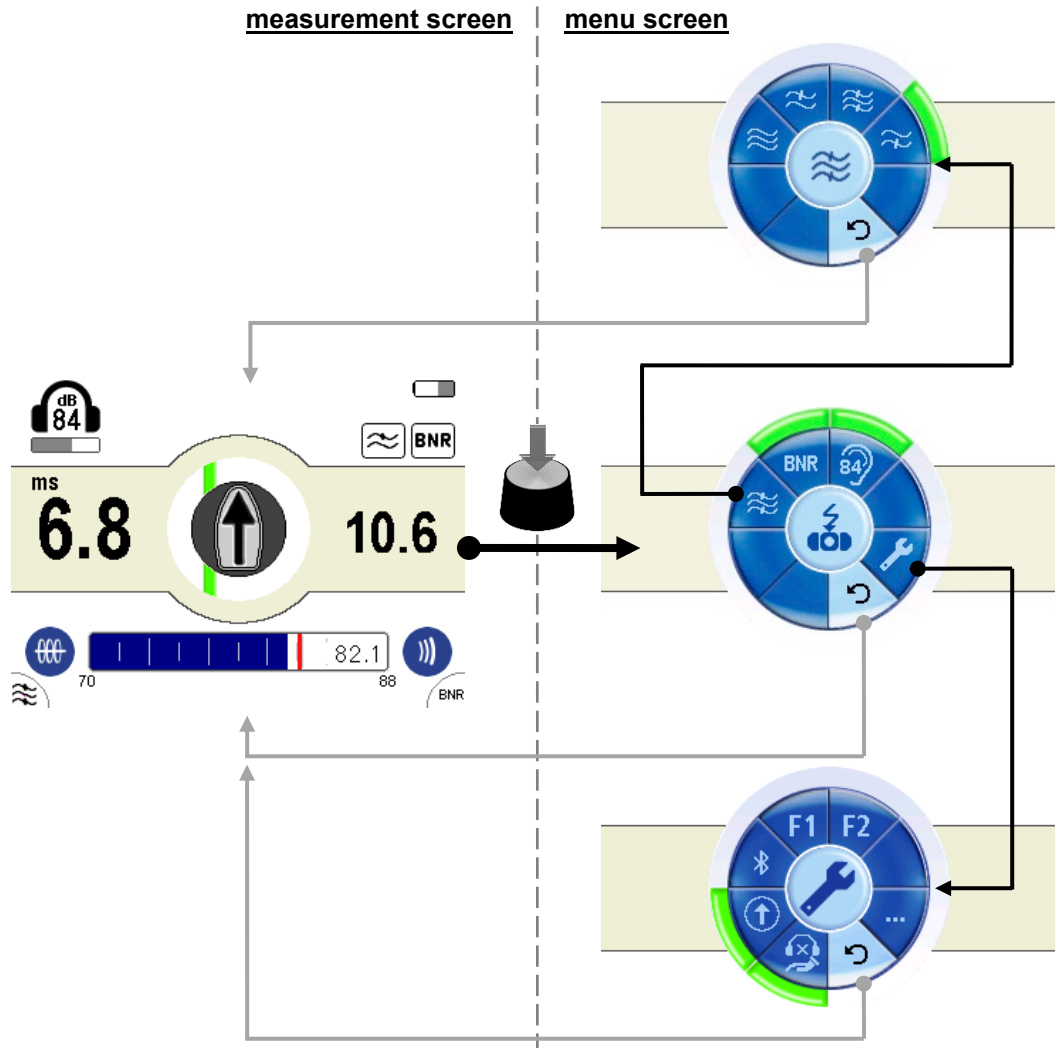

*Layout of the menu screens* Each **menu screen** is made up as follows:

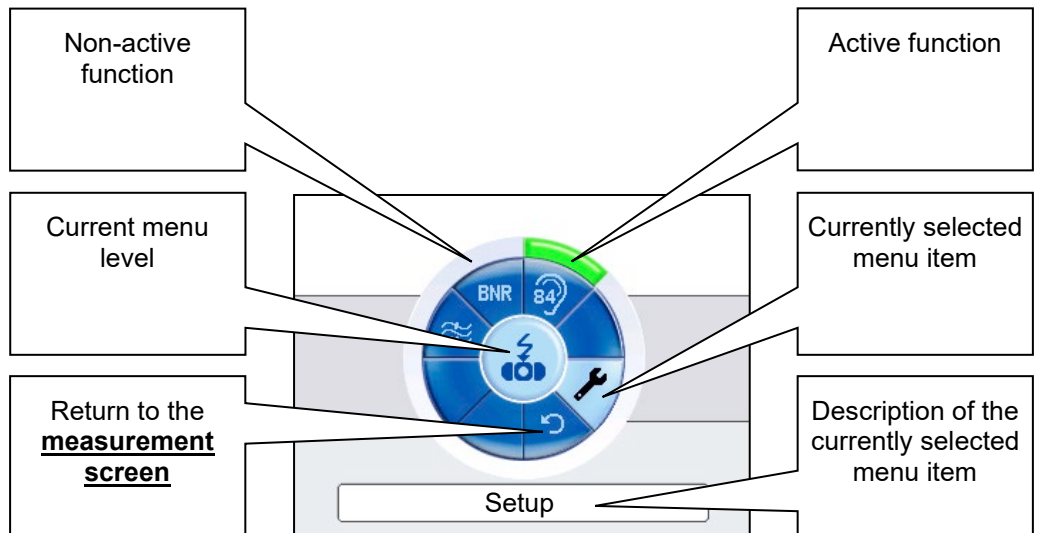









### 4.2.1.1 Adjusting the Basic Settings

After the indicator unit has been switched on, you can adjust the basic settings. To do so, switch to the **menu screen** by pressing the knob and selecting the menu item . The following menu then appears in the display:



You can enter the following basic settings in this menu (the second menu level can be called up via menu item ...):

Menu item	Description
	Activates/deactivates Automatic Proximity Mute (APM). If this function is activated, the headphones are muted as soon as the operator touches the sensor's telescopic handle with their hand. This protects the operator from excessively loud background noise which often occurs when the sensor is moved.
	Activates/deactivates the fault arrow. When the fault direction indicator is activated, an additional direction arrow (see page 30) in the display signals whether the user has moved towards or away from the fault.
	This menu item allows the display unit to be connected to a Bluetooth-enabled headset or GPS receiver (see page 88). When connected to a GPS receiver, the GPS coordinates transmitted by the GPS receiver are permanently displayed on the measurement screen. <div style="text-align: center;"> </div>

Menu item	Description
F1   F2	<p>Using this menu item, the following functions can be assigned to the two function keys of the indicator unit:</p> <ul style="list-style-type: none"> <li data-bbox="576 394 1437 427">  The device can be muted / unmuted by pressing the function key.         </li> <li data-bbox="576 450 1401 517">  Each press of the function key switches between the available filter settings (see page 27).         </li> <li data-bbox="568 533 1326 600"> <p><b>BNR</b> The Background Noise Reduction (see page 27) can be activated/deactivated by pressing the function key.</p> </li> <li data-bbox="568 607 1449 801">  By pressing the function key, the manual setting of the trigger sensitivity <b>for electromagnetic pulses</b> can be activated/deactivated.            Since the electromagnetic triggering indicator is located on the left side of the display, this function can only be assigned to function key <b>F1</b>.         </li> <li data-bbox="576 819 1430 981">  By pressing the function key, the manual setting of the trigger sensitivity <b>for acoustic pulses</b> can be activated/deactivated.            Since the acoustic triggering indicator is located on the right side of the display, this function can only be assigned to function key <b>F2</b>.         </li> </ul>
	Sets the display language.
	<p>Sets the measuring unit.</p> <p>The time difference between the arrival of the magnetic pulse and the flashover noise – i.e. the distance to the fault – can be shown either directly (in milliseconds) or converted into a unit of length (metres or feet).</p> <hr/> <div data-bbox="555 1249 1422 1435" style="border: 1px solid black; padding: 5px;"> <p> To convert time to distance a constant (mean) propagation speed is taken as the basis. However, because the actual ground conditions and hence the sound propagation speed vary greatly, the distances calculated can also differ from the real values to various degrees. The distances displayed can therefore only be considered as guides!</p> </div> <hr/>
	Restores the factory settings.

### 4.2.1.2 Adjusting the Measurement Settings

By pressing the knob, you can at any time switch from the measurement screen to the menu screen with the most important measurement settings:



In this menu you can perform the following measurement settings:

Menu item	Description
BNR	<p>Activates/deactivates Background Noise Reduction (BNR). Background noise reduction is used to make it easier to detect acoustic pulses in environments with a lot of interference. Often it is not possible to distinguish background noise caused by rain or traffic, for example, from the actual signal and this makes acoustic pinpointing more difficult.</p>
84	<p>Activates/deactivates the volume limiter. If this function is activated, the volume is limited to a maximum of 84 dB(A).</p> <hr/> <div style="border: 1px solid black; padding: 5px; margin-bottom: 10px;"> <p><b>i</b> When the volume limiter is being used, acoustic amplification should not be set too high! Excessive amplification, requiring the automatic limiter to constantly intervene, will attenuate the flashover noise. The background noise, on the other hand, would become more dominant as it is also amplified.</p> </div>
Filter icon	Filter settings (see next page)

*Filter settings* Flashover noise has its own varying sound characteristics. The sound propagation is strongly affected by the environment through which the sound travels. The sound propagation speed and the distance to the sound source influence the frequencies received by the sensor. The higher the speed and the smaller the distance, the less the high frequencies are attenuated.





This means, in practice, that on hard surfaces with a high propagation speed (such as stone slabs) a high-pitched flashover noise can be expected. In this case, reducing the less relevant low frequencies using high-pass filtering can therefore have a highly positive effect on the acoustic pinpointing process.

On sandy or soft ground on the other hand, the high frequencies will be greatly attenuated, especially when the sensor is far away from the source of the flashover noise. Accordingly, for this ground conditions, it is advised to suppress the high frequencies using low-pass filtering.

In addition, the sound characteristics can be affected by the type of connection between the sensor and transmission medium.

This frequency behaviour applies of course to the unwanted background noises as well. These are also affected by the composition of the transmission path.

Depending on the situation, you can select one of the filter settings below by pressing the knob when in the **measurement screen** and switching to the **menu screen**:

Setting	Description
	<p><b>Filter off</b></p> <p>This filter setting provides the maximum bandwidth so that the flashover noise can be heard with as little distortion as possible. However, high-level low-frequency interference often occurs which makes time measurement more difficult when filtering is disabled.</p>
	<p><b>Filter setting for long fault distances</b></p> <p>Low-frequency (muffled) flashover noise, for which this filter setting is particularly suitable, mainly occurs when the distance to the fault is large and the ground is soft.</p> <p>Here again, low-frequency interference, not reduced by this setting, usually has a high interference level and makes the time measurement more difficult.</p> <p>However, reducing high frequencies can have a detrimental effect on precisely the sound characteristics of high-pitched flashover noise (hard ground, close to the fault).</p>
	<p><b>Filter setting for short fault distances</b></p> <p>Low-frequency background noise is best reduced with this filter setting. High frequencies are let through completely. The sound characteristics of high-pitched flashover noise in particular (hard ground, close to the fault) are not changed very much by this.</p>
	<p><b>Filter setting for medium fault distances</b></p> <p>A balanced filter setting which suppresses both low and high frequencies. Usually more suitable than the low-pass filter for measuring time.</p> <p>However, reducing high frequencies can have a detrimental effect on precisely the sound characteristics of high-pitched flashover noise (hard ground, close to the fault).</p>

### 4.3 General information on locating faults with the device

#### 4.3.1 Interpreting the measured value and direction data

*Measurement display* The time difference values logged at the current position are always shown on the left-hand side of the display. The values are shown either in grey or black according to the following agreement:

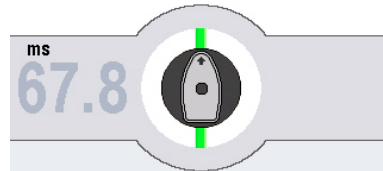

The most recently taken measurement is either the first measurement at a new position or it deviates by more than 10% from the previous measurement

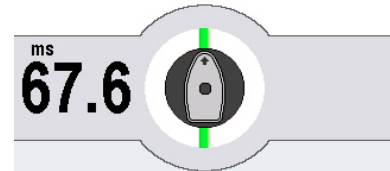

The most recently taken measurement deviates by less than 10% from the previous measurement



If due to constant fluctuations the measurement values are shown only in grey for a longer dwell time, it is recommended to carefully listen to the audio signal. Also, if no periodic acoustic signal can be made out here, it is highly probably that the distance to the fault location is simply too great.

*Position change* A change of position is recognised automatically by the sensor and should, if possible, only be carried out when the current measurement value is shown in black (see above). Only in this case is this last measurement value moved to the right-hand side of the display and regarded as a comparison value at the new position.

The first measurement at a new position is always displayed in grey.

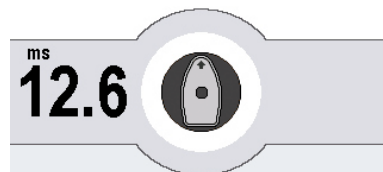

Before position change

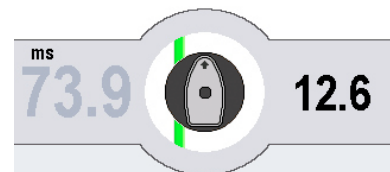

After position change

### How to read the fault arrow

The fault arrow, which can be enabled or disabled through the  menu item in the device settings (see page 25), shows whether the user has moved towards or away from the fault. This message results from a comparison between the last measured time difference of the previous position and the current time difference. The fault arrow can have the following states:

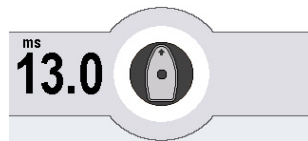

#### no information

In the previous position a transit time difference and therefore a comparative value could not be measured

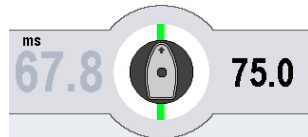

#### no information

The most recently taken measurement deviates by more than 10% from the previous measurement and is not considered for a direction indication



#### closer to the fault

The last change in position decreased the distance to the fault



#### further from the fault

The last change in position increased the distance to the fault

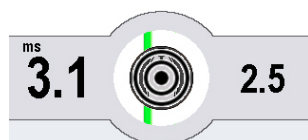

#### in close proximity to the fault

The last two readings indicate that the sensor is placed near the fault position



When pinpointing faults using the fault arrow, you must **always move forwards** with the sensor (in the direction of the arrow on the sensor). If the direction indicator tells you to turn round, you must indeed turn 180° along with the sensor!

### 4.3.2 Volume Settings

*Volume setting* To protect the operator's hearing from excessive sound levels, the volume regulator has a number of protective mechanisms.

The volume is regulated in the **measurement screen** by turning the knob.

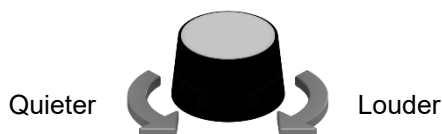

The device settings can limit the maximum sound level to 84 dB(A) through the menu item (see page 27).

*Muting* If one of the two function keys is used as mute button, the headphones can be muted at any time by pressing this key. Muting is switched off by pressing the key again or increasing the volume.



Furthermore, the menu item in the device settings can be used to activate the Automatic Proximity Mute (APM) feature (see page 25). When enabled, muting occurs as soon as your hand touches the telescopic handle. In this mode, manual switching can of course also be performed using the function key. **With APM enabled** the sequence is as follows:

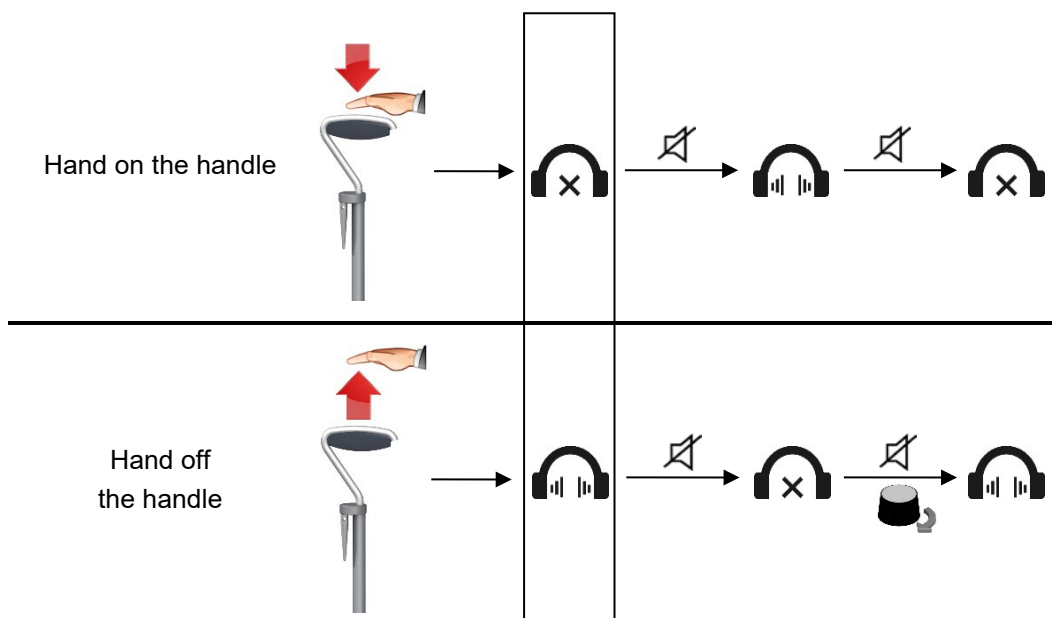

*How staying in one position affects background noise reduction*

When background noise reduction (see page 27) is switched on, the software gathers and analyses information about the interference and signal level. After the first surge pulse from the fault arrives, this information is used to suppress the background noise. Further information is gathered with each additional pulse and the reduction is constantly improved. The longer therefore the operator stays at a position with the sensor receiving pulses, the less audible the interference becomes.

Each time the sensor is moved, the information gained about the background noise is discarded. After each position change, the level analysis starts afresh when the first surge pulse arrives.

The current status is indicated by a symbol on the top of the display (assuming background noise reduction is enabled in the device settings).



After the sensor is moved, there is no information to analyse yet. Background noise reduction is not in operation.



Information collected is being used to reduce background noise.

### 4.3.3 Switching between automatic and manual trigger sensitivity setting

*Introduction* The trigger sensitivity (both for the electromagnetic pulse and the acoustic pulse) is automatically set to the optimal value determined by the software by default. If required, the setting can also be adjusted manually at any time. This is specially designed for experts and allows for fine adjustment, for example if the automatic setting obviously triggers on the wrong pulses or does not react to acoustic pulses that can clearly be heard in the headphones.

In order to be able to switch from automatic to manual trigger sensitivity setting during operation, the function keys of the indicator unit must be assigned the corresponding functions first (see page 25).

*Adjusting the trigger sensitivity manually* By pressing the function key (for the electromagnetic trigger) or (for the acoustic trigger), it is possible to switch from an automatic to a manual sensitivity setting at any time in measuring mode. A circular actual value display now appears around the respective trigger symbol, which symbolises the currently set trigger sensitivity.

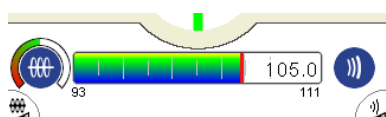

Manual trigger sensitivity setting for **electromagnetic pulses** active

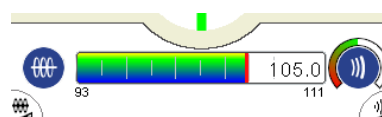

Manual trigger sensitivity setting for **acoustic pulses** active

This reads 50% directly after deactivating automatic mode. The actual value corresponds to the last value that was set by the automatic trigger sensitivity control.

The sensitivity can now be adjusted using the knob on the indicator unit. This means it is not possible to adjust the volume in this mode.

Adjusting the sensitivity has the following effects:

Sensitivity level	Effect
<b>Low sensitivity</b> 	Stronger electromagnetic or acoustic pulses are required before triggering occurs.
<b>High sensitivity</b> 	Triggering occurs even with very weak electromagnetic or acoustic pulses.

**Locking the trigger sensitivity at a specified value** If you would like to adjust the volume in the meantime or just don't want to lose the sensitivity level that is currently set by accidentally turning the knob, you can lock the current setting by pressing the relevant function key a second time. The sensitivity level that is currently set is then marked in grey.

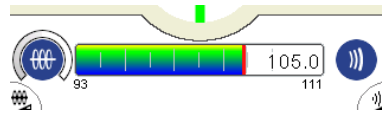

This also happens if both manual sensitivity settings are activated. In this case, the trigger sensitivity level that was activated first is locked while the other sensitivity level can be adjusted manually.

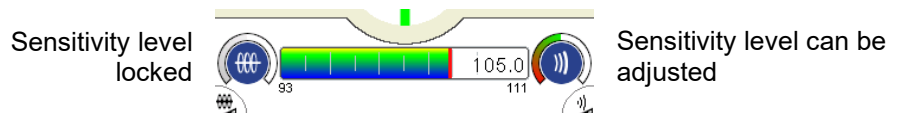

To adjust a sensitivity setting that is locked, briefly press the relevant function key again.

**Deactivating the manual setting** To return to the automatic trigger sensitivity setting, press and hold the relevant function key for at least 3 seconds.



## 4.4 Procedure for fault detection



### 4.4.1 Tracing the Line

After prelocation, it is usually relatively easy to narrow down where the fault lies in the cable.

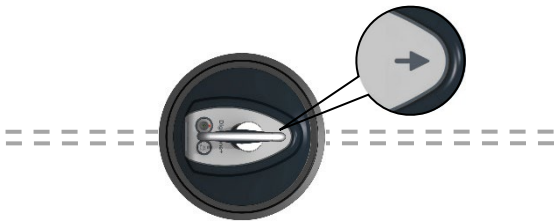
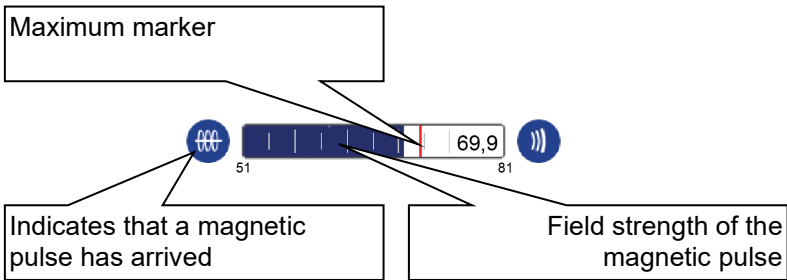
If, however, the area is large because the cable plans are inaccurate, we recommend that you trace the cable with a line location device before pinpointing, and mark its route.

On the other hand, if the area for pinpointing is not too large, all you normally need to do is find a starting position directly over the cable and start pinpointing from here. Please proceed as follows:

Step	Action
1	<p>Place the sensor on the ground with the arrow pointing in the direction where you believe the cable to be running.</p> 
2	<p>Wait until the indicator unit signals the arrival of the magnetic pulse.</p> 
3	<p>If the green cable compass is not displayed at all or jumps back and forth sporadically, the signal strength is not yet sufficiently high to reliably measure the position of the line.</p> <p>In this case, try to improve the signal strength by rotating the sensor around its own axis or moving slowly in different directions. You should do this until the green cable compass is visible and stays in the same position permanently.</p> 

Step	Action
4	<p>Slowly rotate the sensor in the pulse cycle until the green line is shown vertically in the display, i.e. the arrow on the sensor points towards the line routing.</p> 
5	<p>Move the sensor sideways in time with the pulses (crosswise to the cable route) until the indicator shows that it is exactly over the cable. This is the starting position for pinpointing.</p> 

#### 4.4.2 Approaching the Fault

*Technical principles* When pinpointing a cable fault, both the magnetic field created by the surge pulse and the flashover noise are evaluated.

The display on the indicator unit signals when a pulse arrives (the magnetic trigger symbol  light up) which helps to discern the flashover noise from the background noise in the headphones. The "coincidence" of these events enables the user to correctly identify the flashover noise when it occurs at the same time as the magnetic pulse. **The volume of the flashover noise normally continues to rise as you near the fault.**



Another indicator for the distance to the fault is the transit time difference between the magnetic pulse and the acoustic flashover signal which is shown permanently on the display.

The cause of this difference is the varying propagation speed of the two signals in the ground. The magnetic field spreads at about the speed of light, whereas the propagation speed of the flashover noise is considerably less and varies according to the ground conditions. **As you approach the fault the transit time difference decreases.**

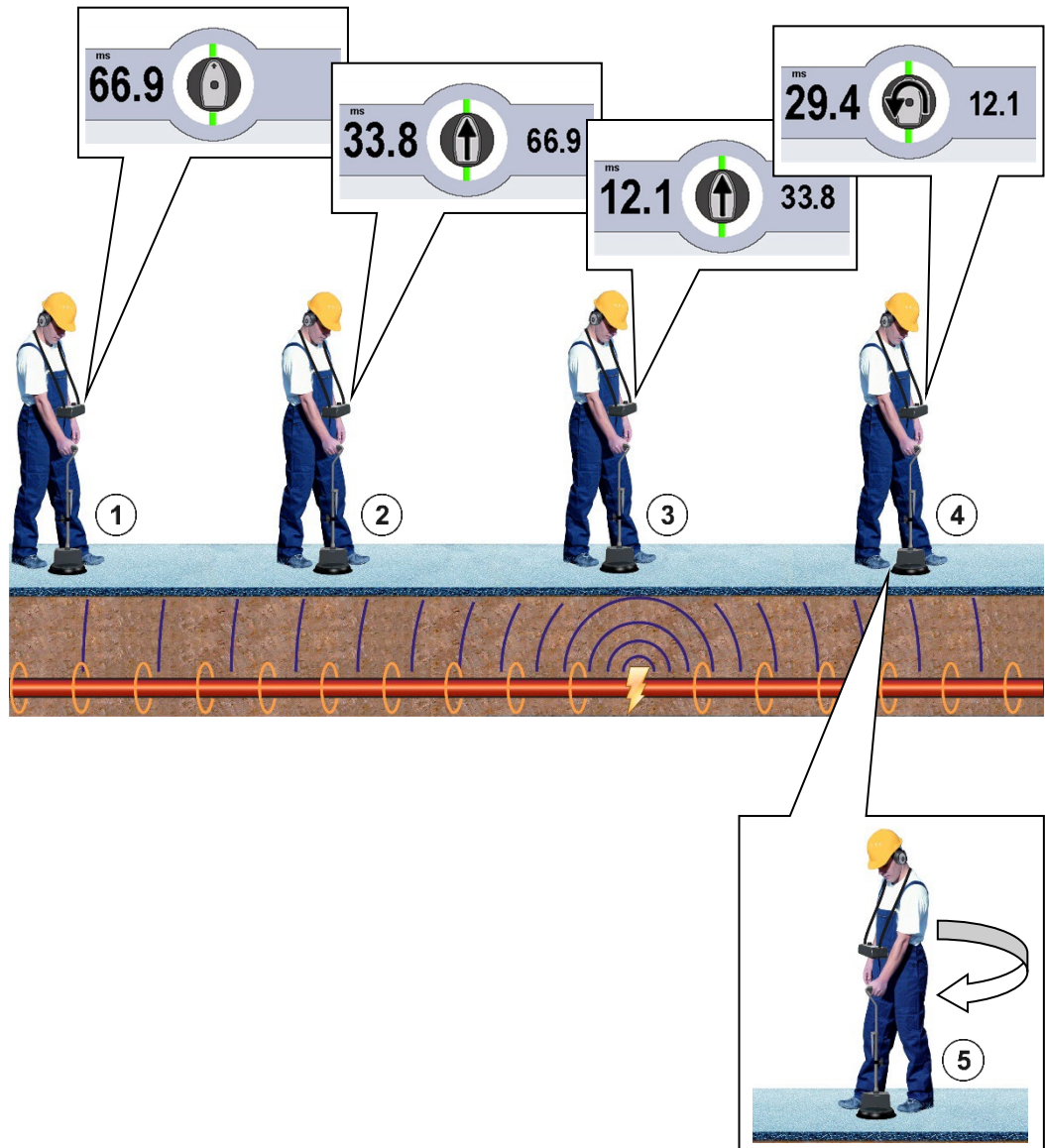
*Diagram* The following is an example of how the indicators (transit time / direction indicator) change as the operator nears and goes past the fault:



*Procedure* This is what to do when approaching the fault:

Step	Action
1	Place the sensor at the starting position (see page 35).
2	<p>If the sensor unit cannot pick up an acoustic signal at this position (the trigger symbol  lights up), follow the route until there is an acoustic trigger.</p> <p>Keep a constant eye on the level of the magnetic pulse and line position shown and, if necessary, correct the alignment (see page 36).</p> <p>When the first useful acoustic signal is detected, the transit time difference (or corresponding distance) is shown on the left of the display (position ① in the example).</p> <p>If no acoustic signal can be picked up using the sensor or the headphones even over a longer section, you should try to continue the search in the other direction (from the starting position).</p>
3	Remain in this position for a few pulses to allow the background noise reduction (see page 37) to improve the accuracy of the measurements and the acoustics.
4	<p>Continue along the cable route one step at a time (correcting the alignment if necessary) and stay for a few pulses in each position.</p> <p>As you near the fault, the transit time difference (distance) shown decreases continually and the direction indicator signals that the change in position is 'positive' ( – positions ② and ③ in the example).</p> <p>When you go past the fault, the transit time difference (distance) suddenly rises again. The fault arrow signals that the measurement has risen ( – position ④ in the example).</p>
5	Turn 180° (position ⑤ in the example) and move towards the fault again <b>taking smaller steps</b> .
6	Establish the position of the minimum absolute reading as accurately as possible and mark it.

*Practical tips*

If you are unsure whether a noise is an acoustic flashover noise or just a repeating background noise, we recommend “resetting” background noise reduction by lifting the sensor briefly and putting it down again. If you then detect a similar noise again during magnetic triggering, it is very likely to be the acoustic flashover noise.



‘Knocking’ can occur inside the installation pipe when the cable strikes the pipe wall or adjacent cable because of the surge energy. This noise spreads from the point where the pipe meets the soil up to the surface, meaning that this could be mistaken for the position of the fault.

You will know that this is a ‘phantom fault’ because the magnetic level (bar deflection) does not – as is usual with a real fault – drop considerably directly after you pass the position. Instead, the magnetic level remains virtually unchanged up to and beyond the fault.



Sometimes, the magnetic signal from the actual target line crosses over to an adjacent line and this adjacent line is displayed by the direction indicator. The operator could then even end up following the wrong line.

We therefore recommend that you trace and mark out the exact route of the cable before pinpointing the fault, especially for areas where there are numerous buried cables. To be completely sure, you should trace the route using a special transmission frequency (e.g. “SignalSelect” mode in the Ferrolux series).

## 4.5 Completing the Work

After the cable fault has been successfully pinpointed, the indicator unit can be turned off by pressing the  button **for 3 seconds**.

Afterwards, the surge wave generator can be switched off and disconnected from the cable under test while making sure that all applicable safety regulations are followed.

## 5 Line and probe location in "Ferrolux" mode

### 5.1 Connecting the sensor and headphones to the display unit

To operate the device in Ferrolux mode, one of the following two sensors must be connected to the socket **5** of the indicator unit:

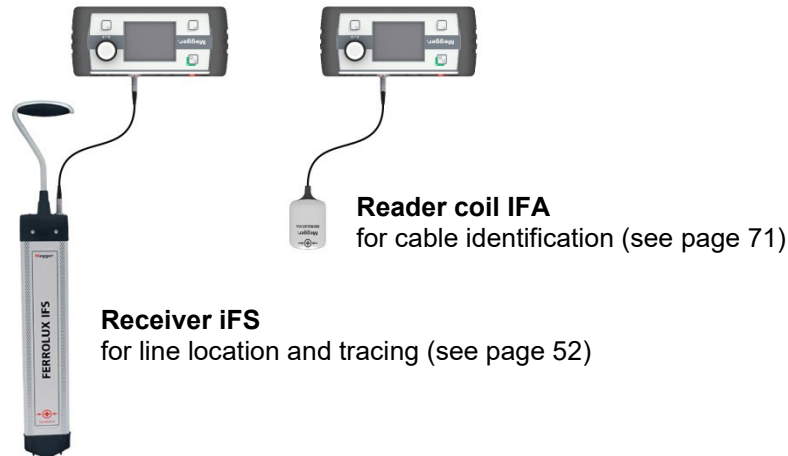

The acoustic signal is emitted during the current positioning in Ferrolux mode via the Pizo loudspeaker integrated into the indicator unit. Use of the headphones is therefore not absolutely necessary in principle, but is recommended especially if the measurement is performed in a particularly noisy environment.

Depending on the headphones used, this is connected to the indicator unit via either a 3.5 mm jack socket **8** or Bluetooth (see page 88).

## 5.2 General information about operation

*Layout of the measurement screen* Immediately after switching on, the **measurement screen** appears. The device is immediately ready to measure.

The **measurement screen** provides all of the relevant information that could be useful for the locating the line or probe as well as the acoustic signal:

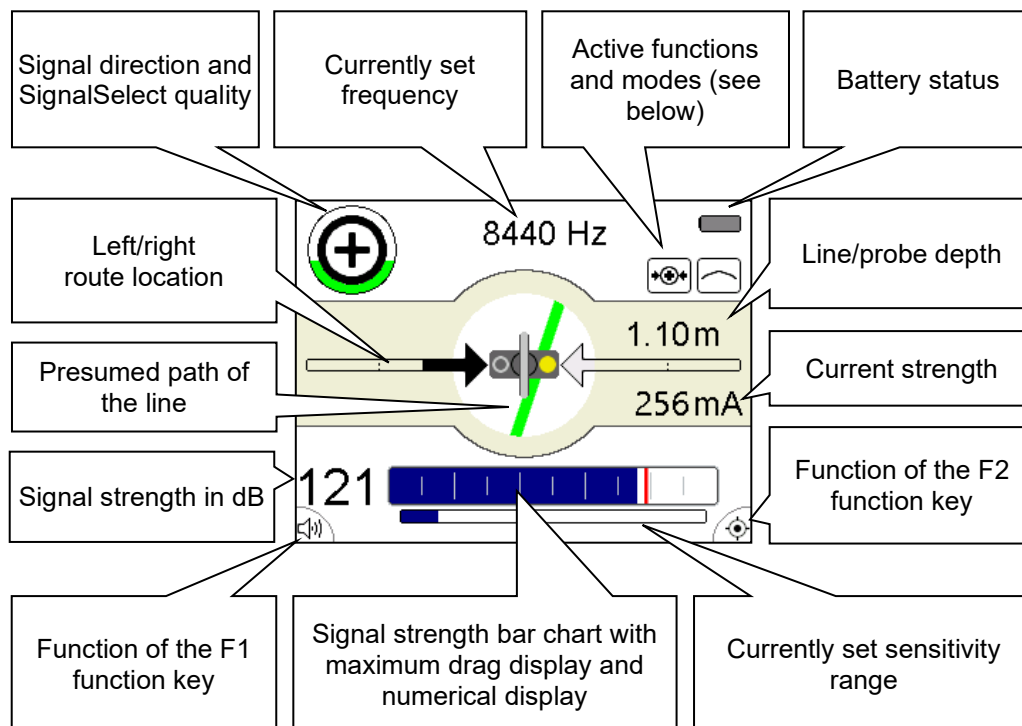

*Active functions and modes* The symbols at the top right of the measurement screen indicate the following functions and measurement modes:

Symbol	Description
	Active measurement method (see page 46)
	Minimum method
	Maximum method
	Super maximum method
	Active frequency selected (see page 46)
	Probe locating mode active (see page 65)
	Bluetooth status messages (see page 88)
	Scanning for visible devices
	Connecting to device
	Headset is connected
	GPS receiver connected



### 5.2.1 Entering settings

*Menu layout* It is possible to switch from the **measurement screen** to the **menu screen** at any time and enter any setting with a maximum of two operating steps:

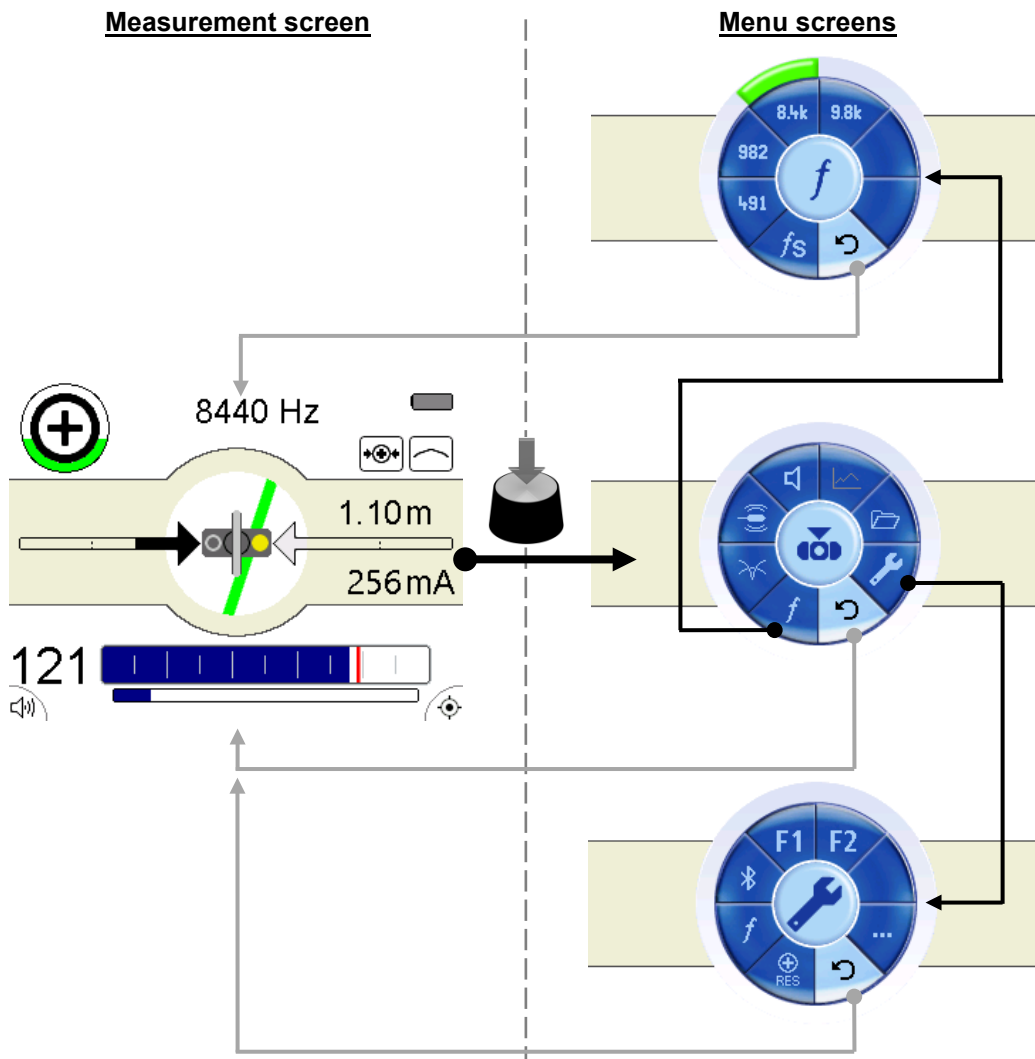

*Elements of the menu screens* By principle, the individual **menu screens** have the following layout:

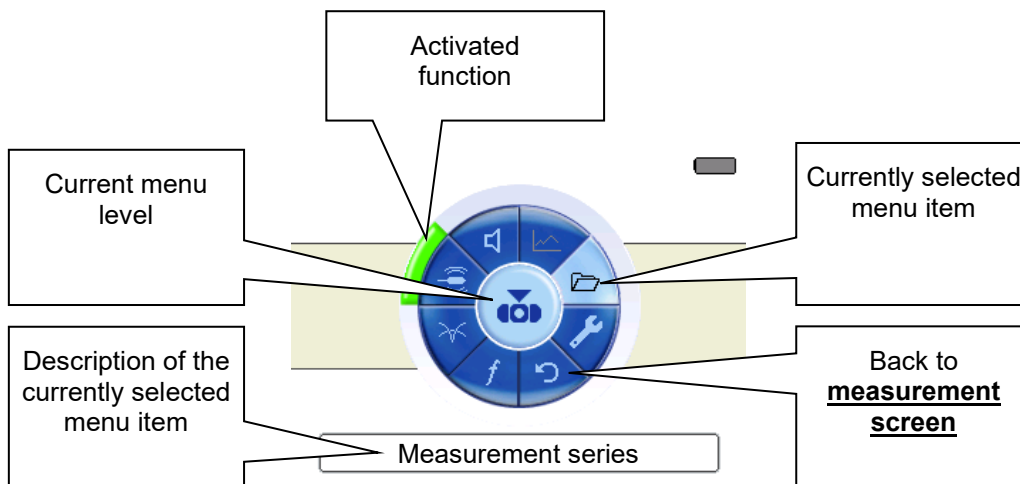











### 5.2.1.1 Entering basic settings

To access the basic settings for Ferrolux mode, the **menu screen** must be opened by pressing the knob and the  menu item selected. The following menu then appears in the display:



You can enter the following basic settings in this menu (the second menu level can be called up via menu item ...):

Menu item	Description
<i>f</i>	<p>Selection of the frequencies that can be activated using the frequency menu. In this way, the selection in the frequency menu can be limited for an improved overview of the frequencies which are actually used on frequent occasions.</p> <p>The second selection list can be called up using the ... menu item.</p>
$\frac{m}{ft}$	<p>Setting the length units (metres or feet).</p>
	<p>This menu item allows the display unit to be connected to a Bluetooth-enabled headset or GPS receiver (see page 88).</p> <p>When connected to a GPS receiver, the GPS coordinates transmitted by the GPS receiver are permanently displayed on the measurement screen. Furthermore, the coordinates are written to the internal memory together with the respective measurement values whenever a new measurement point is saved.</p> <div data-bbox="798 1366 1149 1612" style="text-align: center;"> </div>
	<p>During the locating and tracing of very long wires in SignalSelect mode, so-called capacitive cross talk (i.e. parts of the signal flow into adjacent lines or simply into the ground) causes a phase shift that impedes the unique identification of the line as the distance to the transmitter increases.</p> <p>For this reason, a SignalSelect reset can be carried out with which this phase shift is determined and compensated for using this menu item once directly in the vicinity of the transmitter (see page 53) and, if necessary, also later during the course of tracing.</p>





Menu item	Description
F1   F2	<p>Using this menu item, the following functions can be assigned to the two function keys of the indicator unit:</p> <ul style="list-style-type: none"> <li data-bbox="550 394 1358 456"> Each press of the function key switches between the available measurement methods (see page 46).</li> <li data-bbox="550 472 1434 566"> With each press of the function key, the frequency is changed over. Only the frequencies which have been activated in the basic settings are taken into consideration (see previous page).</li> <li data-bbox="550 584 1441 647"> After pressing the function key, the volume can be adjusted using the selector knob.</li> <li data-bbox="550 663 1355 725"> The mute button can be activated/deactivated by pressing the function key.</li> <li data-bbox="550 741 1441 835"> By pressing the function points, the current measured data and GPS coordinates (only with an existing connection to a Bluetooth receiver) are saved as a new measuring point (see page 50).</li> </ul>
	Current software version
	Sets the display language.
	Reset device to factory settings.

## 5.2.1.2 Entering measurement settings

Pressing the knob allows you to exit the **measurement screen** and directly access the **menu screen** at any time, which contains the most important measurement settings:



The following measurement settings can be entered in this screen:

Menu item	Description
$f$	Select the receive frequency (see page 46)
	Select the measurement method (see page 46)
	Activating / deactivating probe locating mode. This mode is particularly suitable for locating active probes (see page 65), which are characterised by having a different radiating characteristic than a metal conductor.
	Adjusting the speaker or headphone volume In parallel to the bar chart display, the signals recorded by the antennas are also continuously reproduced acoustically via the speakers or the connected headphones in order to give the user an indication of the changes to the signal strength, even when he is not looking at the display. The frequencies which are audible to the human ear are reproduced 1 to 1, whereas all higher and lower frequencies are first converted into audible signals before being played back.
	Using this menu item, the previously recorded measurement series can be displayed in a curve form. The displayed measured quantity can be changed over in the measurement series management (see page 50).
	Menu for measurement series management (see page 50)

**Selecting the frequency** The available receivers support a large quantity of localizable frequencies. These is divided into passive and active frequencies.

Passive frequencies are understood to be those frequencies which are already present on buried lines for operational reasons or are coupled into them inductively. These frequencies can also be located accordingly without using a transmitter. The following passive frequencies are supported:

Passive frequency	Explanation
50 Hz / 60 Hz	Mains voltage frequency
100 Hz / 120 Hz	Frequency of the current that is supplied for the purpose of cathodic corrosion protection in metallic pipeline.
 (15 ... 23 kHz)	Band of radio frequencies that often couple into buried metallic conductors due to their signal strength and characteristics

On the other hand, active frequencies are coupled into the metal conductor with the aid of a suitable transmitter using a direct connection or inductively in order to be able to trace this particular conductor or localize a fault on it. The following active frequencies are supported:

Active frequency	Explanation
480 Hz / 491 Hz / 982 Hz / 1090 Hz / 1450 Hz / 8192 Hz / 8440 Hz / 9800 Hz / 9820 Hz / 32768 Hz	Typical transmission frequencies These frequencies are supported by the majority of the transmitters in the Ferrolux series, and can also be fed in by these as a SignalSelect modulated signal.
512 Hz / 640 Hz	Typical probe frequencies

To change the currently set frequency, the menu screen must be called up by pressing the knob and the *f* menu item selected. In this frequency selection menu, only the frequencies which have been activated in the basic settings are available. If the required frequency cannot be found among them, this must first be activated in the basic settings (see page 44).

If more than 6 frequencies are activated in the basic settings, the selection in the frequency selection menu is divided up into 2 pages. In this case, the second page can be called up using the ... menu item.

A frequency scan can also be activated using the *f<sub>S</sub>* option that is available in the frequency selection menu. In this mode, immediately after confirming the selection all frequencies which have been activated in the basic settings are measured once successively and the frequency at which the highest level was measured is then adjusted automatically. This mode can be particular useful if you are not quite unsure which frequency is set on the transmitter.

**Select locating mode** The iFS receiver can measure in three different locating modes. In each of these modes, the signals picked up by the antenna system are processed in different ways. This means that only the signal received by the vertically arranged antenna is evaluated in minimum mode, whereas the signals from different antennas are combined with each other in super max mode. The signal responses of the indicator unit fail in different ways accordingly. In order to change the currently set method, the menu screen must be called up by pressing the knob and the  menu item selected. The following methods are available:

 - **Maximum method**

 During line tracing with the maximum method, only the signal received by the horizontally arranged antennas of the receiver is evaluated. When a line is approached, the signal level increases slowly and continuously. The maximum signal is found directly above the line.

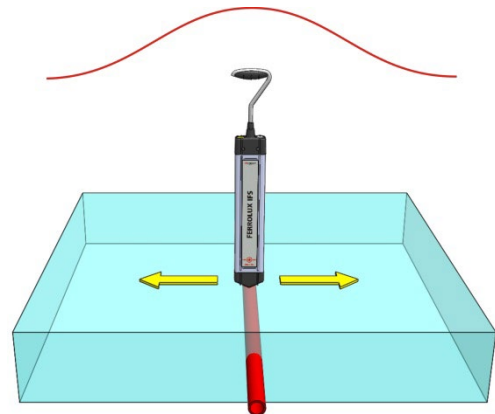

 - **Minimum method**

During line tracing with the minimum method, only the signal received by the vertically arranged antenna is evaluated. The signal display and the pitch are initially greater when a line is approached. A considerable drop in the signal strength must be recorded in close proximity. The signal minimum is located directly vertical above the line.

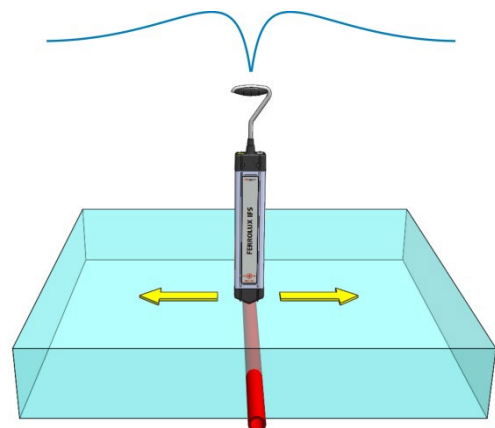

 - **Super maximum method**

During line tracing with the super maximum method, the horizontal component of the received signal and the inverted signal of the vertical component are evaluated. When a line is approached, the signal strength increases suddenly. The strong signal maximum is located directly above the line.

It must be noted that no sidelobe peak is displayed to the right and left next to the super maximum.

The signal maximum is extremely pronounced. In this way, lines lying next to each other are easier to locate and identify.

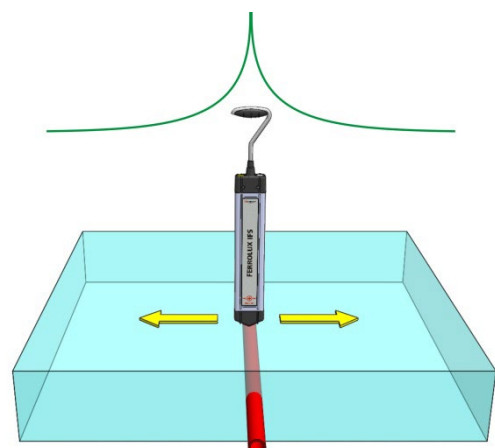

### 5.2.2 Controlling sensitivity

In order to always be able to display the received signals in an optimum way in the bar chart depending on the strength, the receiver can operate in different sensitivity ranges. The currently set sensitivity can be read in a bar directly beneath the bar chart.

**High sensitivity setting** with low signal levels

**Low sensitivity setting** with high signal levels

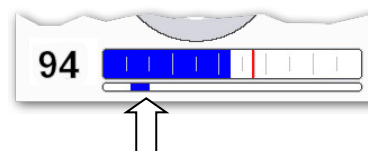
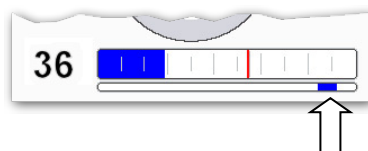

The receiver operates with a high sensitivity setting immediately after switching on. The sensitivity drops automatically in accordance with the recorded signal level so much that the previously measured maximum level corresponds to the maximum deflection of the bar chart.

On the other hand, an automatic sensitivity increase does not take place, so that the levels always remain comparable to the previous maximum level.

However, the user can adjust the sensitivity using the knob at any time while he is in the **measurement screen**.



In this way, the sensitivity can at least be increased again manually if the signal level drops significantly during the course of location / tracing for some reason or other and only extremely weak deflections take place, even at the signal maximum.

Alternatively, a reset of the sensitivity setting can be forced by pressing the knob twice, after which the receiver adapts itself to the currently measured level and then reduces the sensitivity as the level increases.

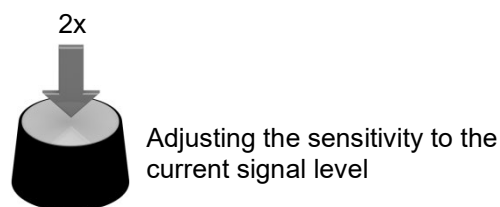

If the sensitivity range under the bar chart is displayed in red, a very high sensitivity is set due to a weak signal level. In this sensitivity range, a reliable location of the searched object may prove difficult.

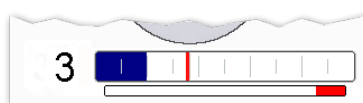

### 5.2.3 Recording and managing measurement series

*Saving measurement points* During the ongoing measurement, the measurement values (signal level, depth, voltage) recorded directly above the line can be stored as measurement points, and entire measurement series formed over the course of the measurement. If the indicator unit is connected to a GPS receiver (see page 88) during the measurement, the associated GPS coordinates for each measurement point are also stored, which makes convenient visualisation of the traced line paths possible on the PC (see page 92).

In order to be able to save a measurement point, this function must be assigned (see page 44) one of the two function keys. If this function key is then pressed during a measurement, the current measurement values and also the GPS coordinates (if possible) are added to the current measurement series as a new measurement point. As a result, the diagram with the measurement values recorded up to this point is displayed for about 3 seconds, before the indicator unit automatically switches back to the measurement screen.

The saving of a measurement point is only possible if the receiver is directly above the line. Otherwise, the function key is inactive.

Saving of measurement point possible

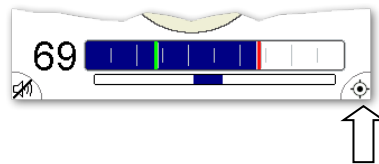

Saving of measurement point not possible

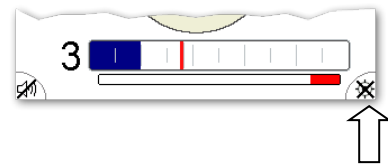





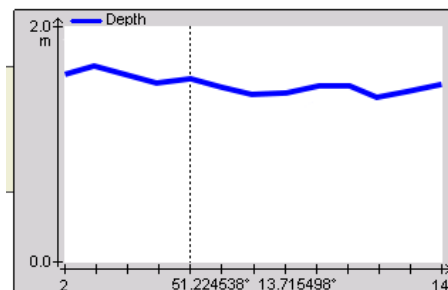







*Displaying the current measuring series* The diagram of the measurement series can be called up at any time using the menu item  $\sqrt{\wedge}$ . However, the prerequisite for this is that at least one measurement point has already been saved.

By turning the rotary knob, you can scroll with a marker through the individual measurement points. If the measurement series was recorded with a GPS receiver connected, the GPS coordinates of the respective measurement point are displayed below the diagram.



The measured quantity shown in the diagram can be changed if required (see below).

*Managing measurement series* The currently recorded measurement series and also saved measurement series can be managed using a menu which has been specially provided for this purpose, which can be called up directly from the menu screen using menu item . This menu provides the following functions:

Menu item	Description
	<p>The measured quantity displayed in the diagram can be changed using this menu item. The following diagram types are available:</p> <ul style="list-style-type: none"> <li> Trend of the recorded current values</li> <li> Trend of the recorded depth values</li> <li> Trend of the signal levels measured with the maximum method</li> <li> Trend of the signal levels measured with the minimum method</li> </ul> <p>The selection that is made here does not apply to the currently recorded diagram, but also for the display of the stored measurement series (see below).</p>
	<p>Using this menu item, the currently recorded measurement series can be put into the internal device memory and called up from this at any time for comparison purposes.</p> <p>Immediately after saving, the current measurement series is reset and a new measurement series started as soon as the next measurement point is saved.</p>
	<p>Using this menu item, the currently recorded measurement series can be reset without the values being placed permanently into the internal memory.</p> <p>A new measurement series is started as soon as the next measurement point is saved.</p>
	<p>Using this menu, the saved measurement series can be selected and displayed again.</p> <p>All recorded measurement series are given a number whereby the numbering starts at 1 with the last stored measurement series and increases with as the storage duration of the measurement series increases. If there are more than 6 measurement series in the memory, the measurement series are distributed over several menu screens. Older measurement series can be called up using the  menu item in this case.</p> <p>If one of the measurement series is selected, it is not only displayed but also marked at the same time. A measurement series marked in this way can then be deleted individually from the internal memory (see below).</p>
	<p>Using this menu item, you can delete measurement series from the internal memory.</p> <ul style="list-style-type: none"> <li> Only the currently marked measurement series (see above) is deleted.</li> <li> All measurement series in the internal memory are deleted.</li> </ul>

### 5.3 Line location and tracing using the iFS receiver

#### 5.3.1 Basics for using the iFS receiver

In order for the orientation aids displayed on the indicator unit (such as path of the line, direction arrows and signal flow direction) to also actually reflect the correct position and alignment with reference to the line or probe to be located, the receiver must be carried laterally in front of or next to the body, and the side marked  must be facing the front. The indicator unit must be worn on the body so that the connections are located at the side furthest away from the body.

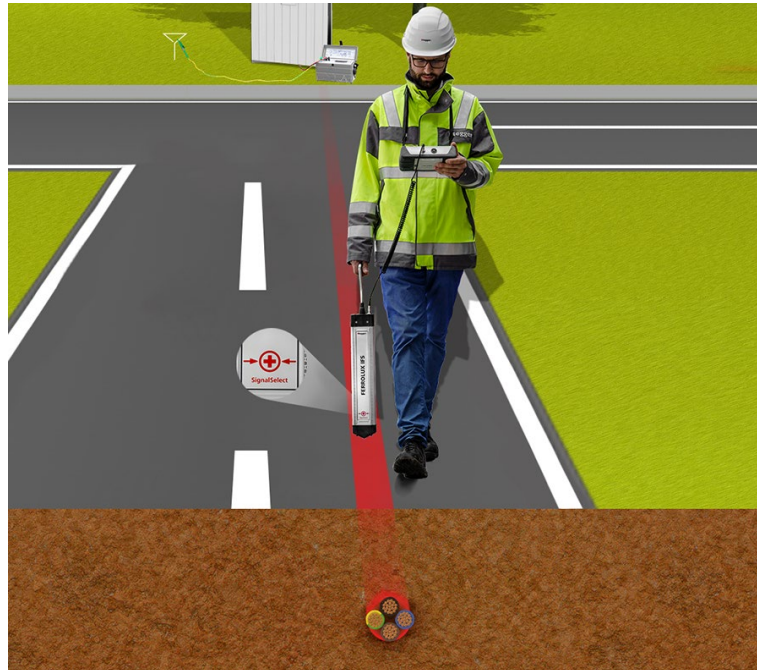

To ensure that the user has the most ergonomic posture possible, the handle of the receiver can be rotated around its axis in steps of 90°. To do this, push the handle downwards a little until it noticeably engages in the required position.



### 5.3.2 Preparation

*transmitting a signal on the line* If not only a basic terrain sounding is being carried out but a particular line is also to be located, a signal with a frequency (see page 46) supported by the iFS receiver must be coupled into this line with the aid of a suitable transmitter.





For information on how to connect and commission the transmitter, please refer to the associated operating manual.

*SignalSelect reset* In order to ensure that the best possible performance is achieved in locating a line on which a SignalSelect signal is transmitted, a SignalSelect reset should be performed in the vicinity of the connecting point after connecting and commissioning the transmitter. The transmitter and receiver are synchronised with each other in this way and a possible phase shift is compensated for. The use of this test also ensures that the connection lines have not been unintentionally connected the wrong way round. If no SignalSelect-coded signal is coupled in by the transmitter that is used, the reset does not need to be carried out, of course.

Proceed as follows to carry out a SignalSelect reset:

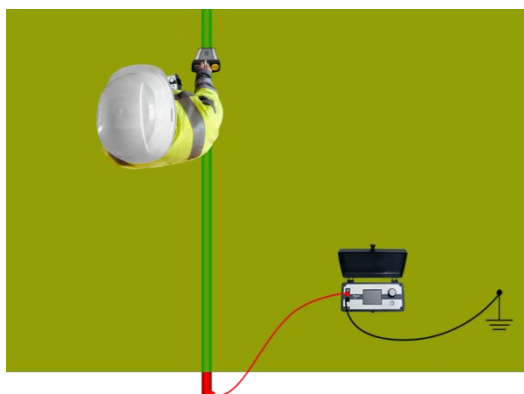
Step	Action
1	Find a position several metres away from the connection point where you are certain that the line runs exactly beneath it.
2	Make the appropriate measurement settings (see page 46) at the indicator unit for the transmitter settings.
3	Hold the receiver above the line in such a way that the side with the printed  is facing away from the transmitter in the direction of the far end of the cable.



Step	Action
4	<p>Ensure that you are exactly above the line using the available direction indicator (see page 55).</p> <p><b>Result:</b> The quality of the SignalSelect detection (see page 58) should be either very high or maximum, and the ⊕ should be indicating the correct signal flow direction.</p> 
5	<p>If the circle around the SignalSelect display is not completely filled in green, call up the ⊕<sub>RES</sub> menu item in the 🔧 menu to carry out a SignalSelect reset and synchronise the receiver with the transmitter signal in an optimum way.</p>

### 5.3.3 Locating the line

*Introduction* If a line does not have to be traced the entire way from the connection point but instead only a certain section of the line needs to be detected, the line must first be located in this area and its orientation determined.

It basically does not matter whether the line that is being searched for is an actively transmitting line or a line with a passive signal frequency (e.g. a live power cable) – the basic locating of the line and the determining of the line direction basically function in the same way.

*Detecting the signal and finding the correct direction* Once the measurement settings have been set (see page 46) in accordance with the signal to be located, the area of the expected line path must first be paced off and examined for a significant level deflection. The maximum method is particularly suitable for this general locating of the line, since this also provides a signal response at quite a distance from the line. However, with very deep lines the super maximum method may be the better option.

A good indication of the fact that a sufficiently strong signal level is being received from the line being searched for is the green line that is shown on the display indicating the supposed path of the line. If this no longer arbitrarily jumps back and forth but remains on one orientation and reacts plausibly to the rotary movements of the receiver, the line path has been reliably measured by the receiver.

In the first step, the receiver should now only be rotated around its own axis until the green line runs vertically in the display, and the receiver is lateral to the expected path of the line accordingly.

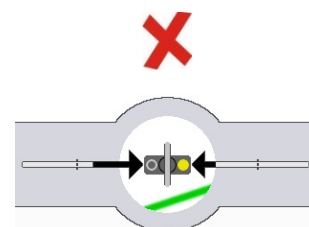
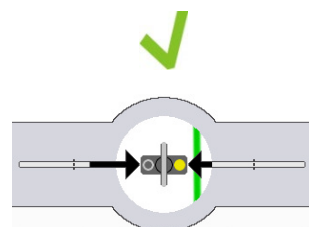
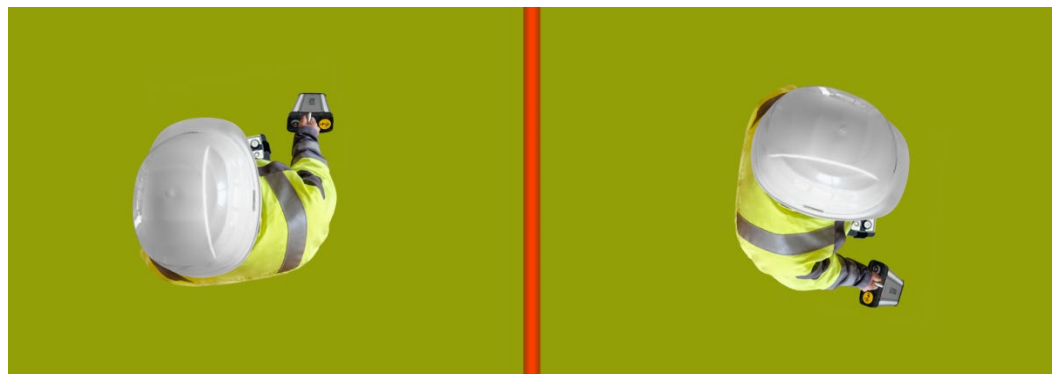

*Locating the signal maximum* Once the receiver has the correct alignment, the signal maximum and therefore the position directly above the cable should now be located by gradually approaching from the side. This work step can also generally be started with the maximum method. When pinpointing in the immediate vicinity of the line, it is advisable to use the super maximum or the minimum method.

The direction of approach is indicated by the black arrows on the left and right next to the receiver icon. The following applies: the more the arrow is filled in, the further away the line is.

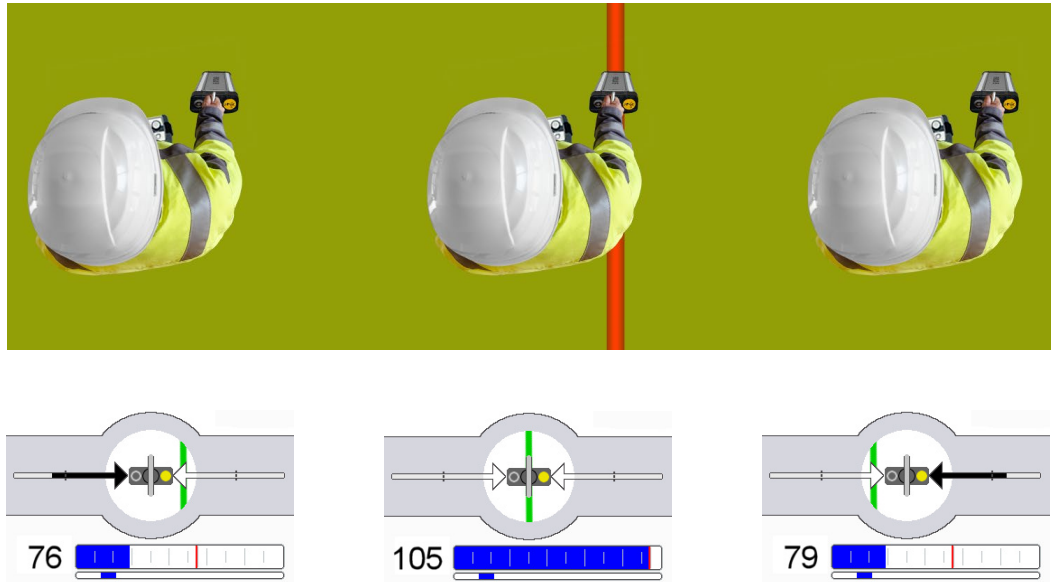

The filling of the arrow should decrease while approaching in the indicated direction, the signal level should increase and the green line should move further toward the centre. At the point of the absolute signal maximum (with minimum method: signal minimum), the receiver is located directly above the line.

In this way the ideal output point is reached for clearly identifying the line, tracing it or carrying out a current and depth measurement, as described in the following sections.

### 5.3.4 Clear identification of the line on the basis of the current flow direction (only possible with SignalSelect-modulated signal)

*Introduction* If the transmitter couples a SignalSelect-modulated signal into the line that is being located, its current flow direction can be identified with the iFS receiver and therefore the line on which a signal is being transmitted can be clearly identified. This is particularly useful, if several lines (cables, pipelines) are running close to each other. In these cases, the return current often couples into the adjacent lines, since these have the least transition resistance. Even if the signal strength is significantly lower on these lines, the signal level received at the surface could adopt similar values in unfavourable cases if the line on which the signal is being transmitted is laid significantly deeper than the adjacent lines, for example.



Please read the associated operating manual for information about how SignalSelect mode is activated at the transmitter.

---

---

*Determining the signal direction* A prerequisite for correct evaluation of the SignalSelect indication is knowledge of your own orientation in relation to the signal injection point. This should generally be located behind the user. If this is the case, the following rules apply:

- A  $\oplus$  is shown in the SignalSelect display above the line on which the signal is being transmitted.
- A  $\ominus$  is displayed on the SignalSelect screen above all adjacent lines on which the signal is flowing back in the direction of the connection point.

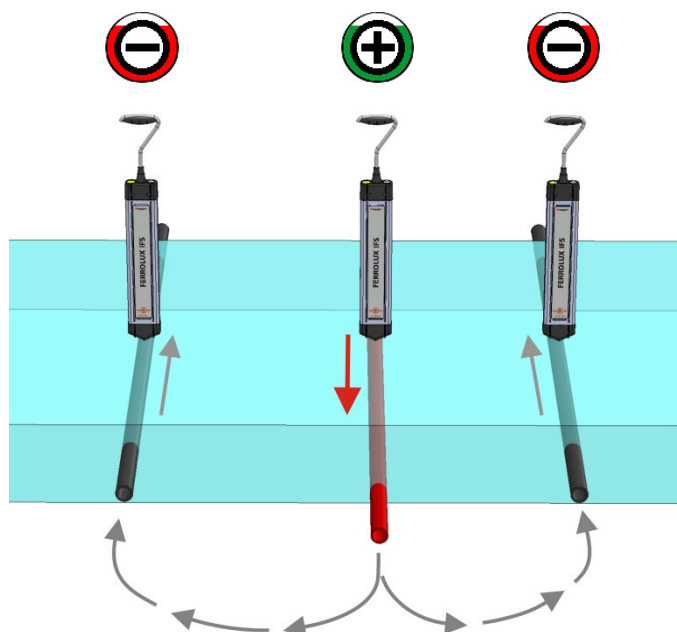

*Quality of the SignalSelect detection* The filling of the outer ring reflects the quality of the SignalSelect detection. The following applies: **The clearer the SignalSelect detection, the higher the fill level.**



The SignalSelect signal can be very easily identified, and there is only very little distortion (forward phase shift).



Though the SignalSelect signal can be identified, the determination of the current flow direction is less reliable due to the high level of distortion (phase shift). The causes of this can be a distance-related phase shift or even a significant capacitive coupling in a line that is laid shallower (see below).



The located line is either not carrying a SignalSelect signal, or the signal-to-noise ratio is too low to clearly identify the signal and the current flow direction.

As the distance to the connection point increases, the phase shift against the injected signal can very slowly but steadily increase due to the capacitive outflow, which is reflected in a reduction in the quality fill level. To counteract this and compensate for the phase shift internally, another SignalSelect reset should be carried out, provided that the line and the current flow direction can still be clearly determined. The procedure is the same as the one for carrying out an initial reset at the connection point (see page 53). However, another adjustment should normally only be necessary a few kilometres away from the fault location.

The quality fill level can also drop relatively abruptly regardless of the distance to the connection point if a strong coupling takes place in another line which is running parallel to the line carrying the signal at a shallower laying depth or crosses it, for example. In this case, the current direction is the same in both lines, which results in a high level of distortion directly above the lines. As shown in the following example, this can lead to the quality being very low at this location, but increasing significantly to the left and right of the lines.

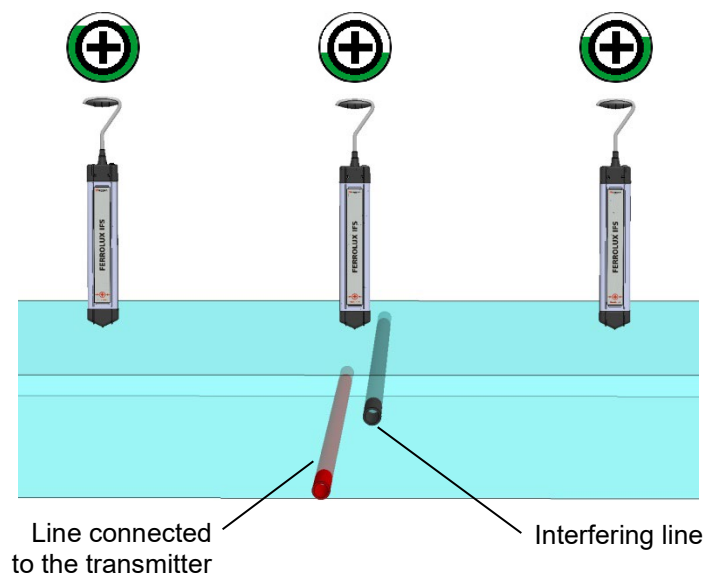

This is due to the fact that the influence of the weaker, overcoupled signal decreases as the lateral distance increases, and the actual signal on the line on which it is being transmitted can be clearly determined again accordingly.

### 5.3.5 Depth measurement

*Introduction* The iFS receiver makes it possible to determine the depth both on actively signal-carrying lines and passive lines which are carrying a current with a frequency of 50, 60, 100 or 120 Hz. No depth measurement is possible in passive radio frequency mode. Insofar as the signal strength allows the laying depth to be calculated, this is permanently displayed at the right-hand edge of the screen.

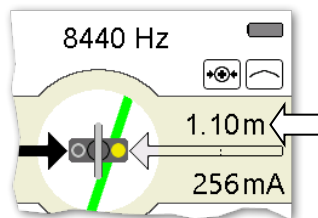

The measurement results on lines which are carrying a transmitter signal must be regarded as more reliable, since the likelihood of interference from adjacent supply lines with the same mains frequency is greater with passive frequencies.

	<p><b>NOTE</b>  <b>Risk of damage to buried lines</b>                  The measured depth value should not be regarded as assured, since a range of outside influences can affect the accuracy of the depth measurement. Proceed with appropriate caution during excavation work!</p>
--	---

*Suitable position for a depth measurement* The prerequisite for the most accurate depth measurement possible is that the receiver should be in as exact a position as possible and in the right orientation above the line (see page 55) or the probe (see page 65).

Furthermore, when determining the depth on lines it must be ensured that the measurement is not carried out in the immediate vicinity of a bend / junction or the transmitter (with inductive signal coupling), and that the measurement is not influenced by any adjacent lines.

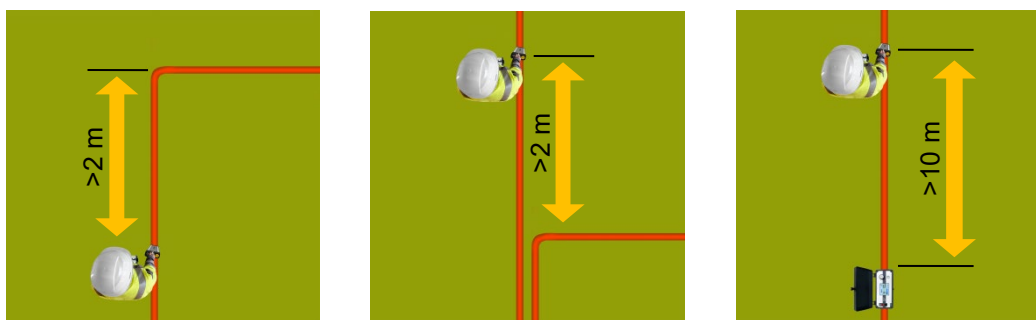

*Verifying the measuring results*

If there is any doubt about the accuracy of the measured values or knowledge of the exact laying depth is extremely important due to forthcoming excavation work, the receiver can be raised about 20 cm above the ground to check whether the displayed depth increases by exactly this value. Also, the carrying out more depth measurements several metres along the path of the line can be used to verify the measurements.

If you are certain that the measurement value is not being influenced by a parallel-running line, checking using the 45° method is recommended. This means that if the receiver is offset to the side at an angle of 45° to the path of the line, the lateral distance to the line corresponds to the depth of the line.

Proceed as follows to check this for the current target line.

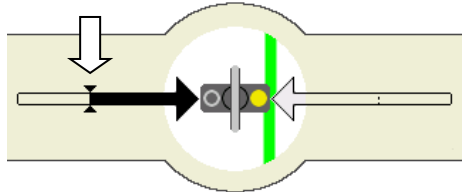
Step	Action
1	Select the maximum method in the measurement settings (see page 46). The 45° method only works in this mode as described.
2	Hold the receiver exactly above the line in the location where you have taken the depth measurement. If possible, mark this position.
3	Move away at side of the line until the direction arrow is filled to the 45° mark in the display, and two small arrows appear. 
	Note the distance between the receiver and the marked line position.
4	Go back to the marked position above the line and repeat step 3 in the other direction.

If the distance from the marked line position in relation to the two 45° positions approximately correspond to the depth measured above the line, it can be assumed that

the measurement result has not been influenced by adjacent lines, or only slightly influenced.

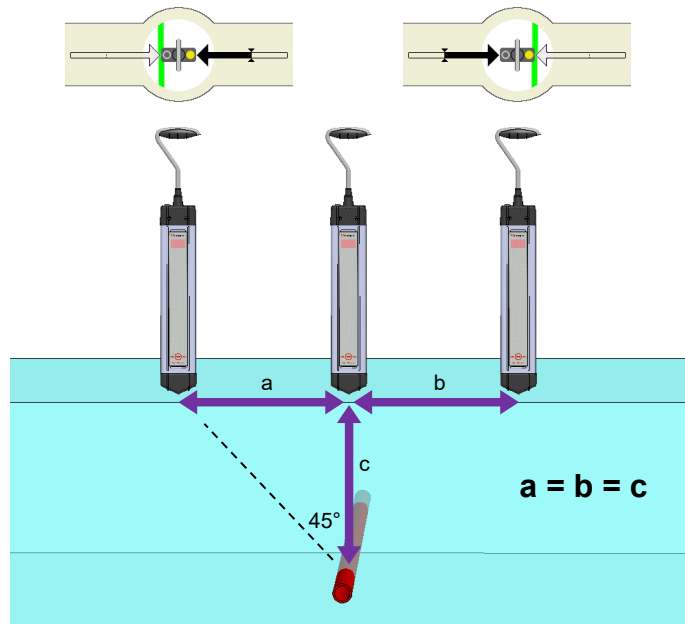

The situation is different if the transmitter signal is coupled into an adjacent line or a second supply line with the same mains frequency is running directly parallel to the line. A significantly less homogeneous field therefore forms around the lines, which leads to a significant difference between the measured distances.

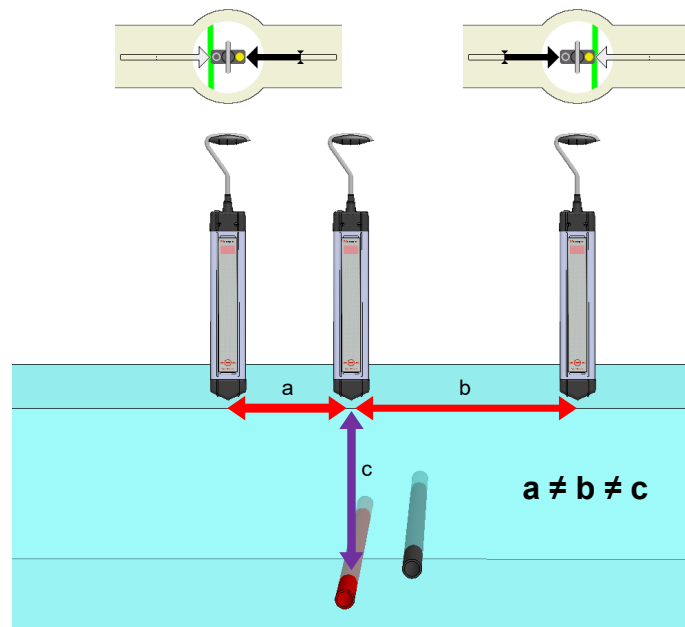

### 5.3.6 Line tracing

**Introduction** If the entire course of a line needs to be traced (e.g. for the purpose of mapping), it is advisable to connect the transmitter directly to the line and start tracing at the connection point. As low a signal frequency as possible is recommended for this application. Provided that it is supported by the transmitter, a SignalSelect-coded signal should be coupled in. This makes it much easier to identify lines that run in parallel during tracing.

Basically, current-carrying lines that cannot be disconnected from the mains can also be traced. To prevent mix-ups with other supply lines, a suitable transmitter should be placed directly above the line to be traced, and a high-frequency signal (e.g. 9.8 kHz or 33 kHz) coupled in inductively.

If only part of the line needs to be traced (e.g. for terrain examination as preparation for excavation work), the first step is to find the line in the affected area and determine its alignment. If a direct connection to the line is not possible, inductive signal coupling should also be carried out in this case if possible using a transmitter placed directly above the line. The optimal positioning of the transmitter depends on the type of transmitter that is used and its antenna arrangement.

**Procedure** The receiver should be operated in super maximum mode during line tracing. In this mode, a small offset to the line that is being searched for is reflected in a considerable level drop.

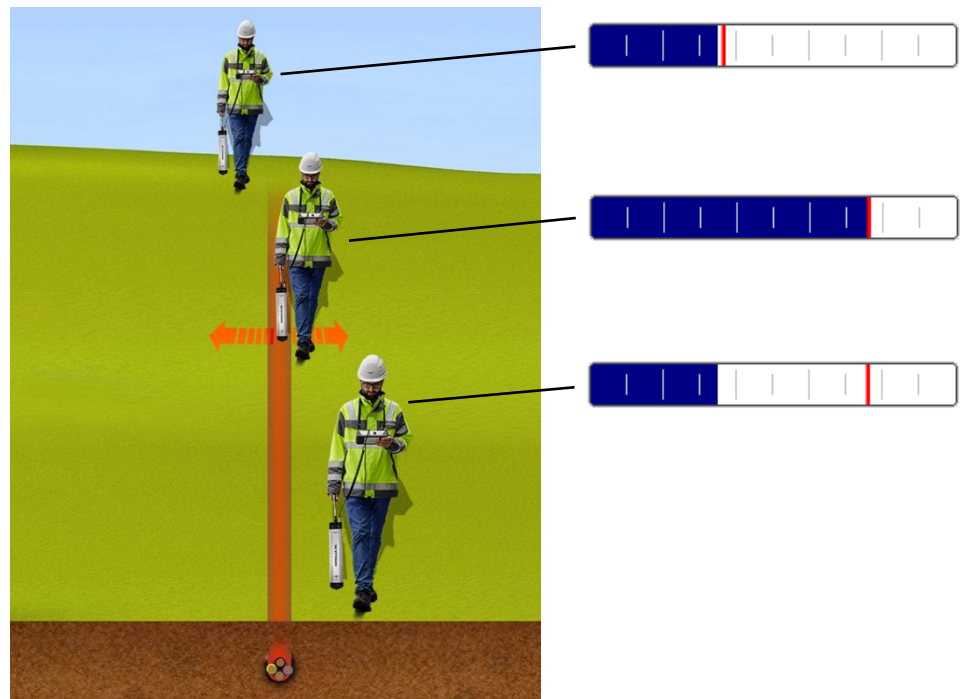

To keep track of the signal level, current and depth measurements during line tracing, a measurement point should be saved (see page 50) at short intervals. If the indicator unit is coupled with a GPS receiver (see page 44), the GPS coordinates of the individual measurement points are also stored. A map display of the path of the line can be created in the office later using this data.

Branches in the path of the line can be recognised from the fact that the current is divided between both lines. The ratio depends on the length of the respective branches and the earthing conditions.

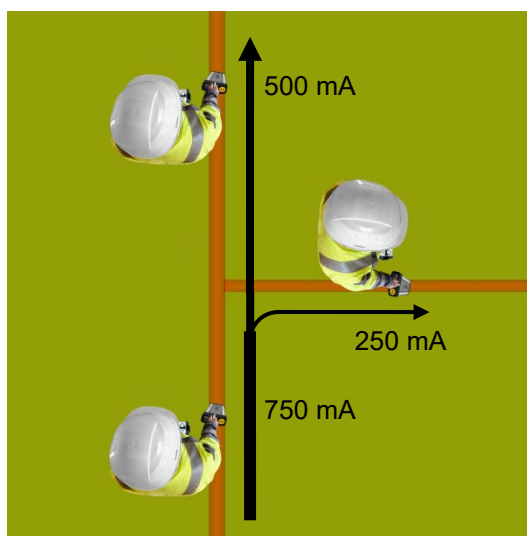

### 5.3.7 Terrain examination

The iFS receiver is also ideally suitable for searching a certain area for buried metallic lines, which may be necessary particularly before excavation work.

Examination can be carried out in the passive frequency ranges (mains frequency, radio frequencies) as well as with the aid of a transmitter with inductive signal coupling.

In order to really be able to detect each metallic line, the area should be traversed laterally and longitudinally as shown in the following example pattern.

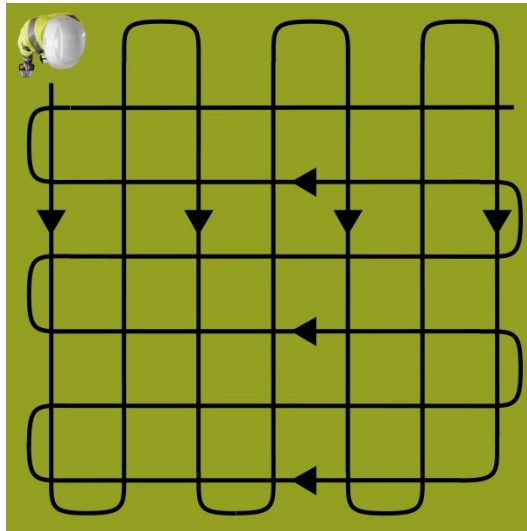

The sensitivity must be set to maximum at the beginning of the terrain examination. It is automatically reduced as soon as a signal response is detected. Each detected line should be routed and marked in both directions as far as the location at which it leaves the area that is being examined. Terrain examination should then continue.

The following notes must be taken into consideration during terrain examination:

- Examination must take place in **maximum mode**.
- When a transmitter is being used, it must be set to the **highest possible frequency** (e.g. 9.8 kHz or 33 kHz), since these frequencies are particularly suitable for inductive signal coupling.
- When a transmitter is being used, it must also be placed in other locations during the course of the examination, and the alignment thereof varied. A **distance of >5 m between the transmitter and receiver** must also be maintained during the entire examination.

## 5.4 Locating probes

*Introduction* Probes are the preferred means used to identify the routing of non-metallic lines or the position of a camera probe. There are active probes, which generate the transmitted signal themselves, and passive probes, which are connected to an appropriate transmitter via a cable. Depending on the field of application, the probes also differ in design, transmission power and frequency. For example, camera probes typically transmit at a low frequency (512 Hz/640 Hz) so that the signal can extend even beyond metallic lines.



If the receiver is positioned directly above the probe and the two are aligned, the maximum signal is measured.

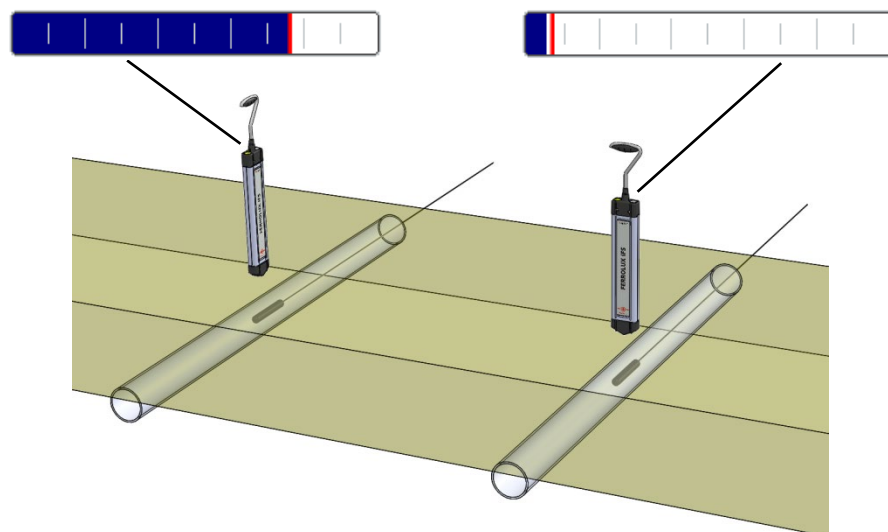

The typical emission characteristic of a probe causes, at the surface, the waveform shown in the following figure, which is characterized by two minimum positions.

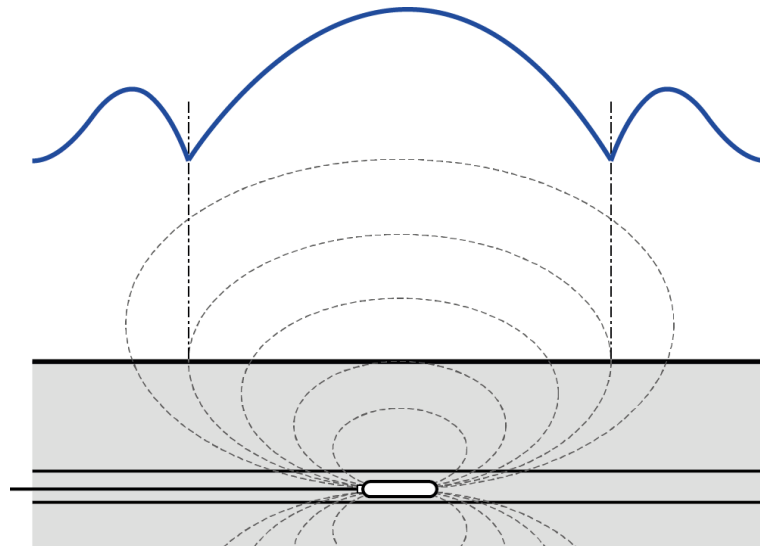

*Procedure* Use the following procedure to locate the position of a probe.

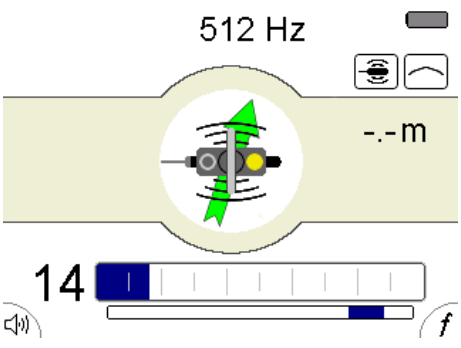
Step	Action
1	<p>Activate probe location mode (see page 46).</p> <p><b>Result:</b> The  symbol indicates that probe location mode is activated. A compass needle appears in the centre of the display, which --f the receiver is correctly aligned --ndicates the direction of the probe.</p> 
2	<p>Select the frequency of the probe or the transmitter to which the probe is connected (see page 46).</p> <p>The locating mode cannot be changed. Probe location is always conducted in maximum mode.</p>
3	<p>If possible, push the probe only a few metres into the line initially; this will allow you to assess its position with reasonable accuracy.</p>

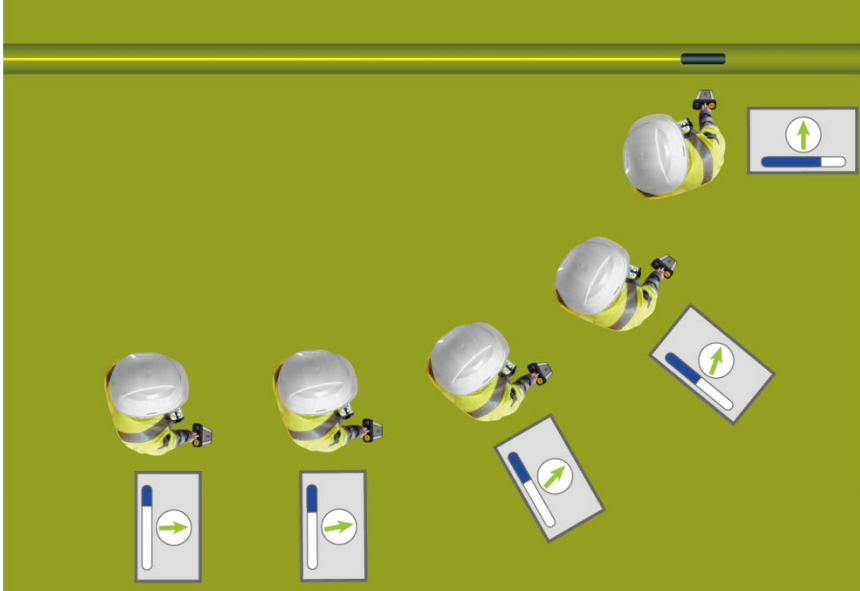
Step	Action
4	<p>Use the receiver to detect the signal from the probe and then follow the compass arrow in the centre of the display — this will take you to the location of the probe. Depending on your initial position, however, <b><u>you may not approach the probe via the shortest possible path</u></b>. Ensure that the receiver is aligned correctly.</p>  <p>As you move toward the location of the probe, the signal level will increase steadily. As soon as you move beyond the location of the probe, the signal level will decrease again.</p>
5	<p>Determine the position at which you receive the maximum signal strength and verify this by moving the receiver approximately half a metre to the left, right, front and rear.</p> <p>If the purpose of locating the probe is to trace a line, it is advisable to mark the position or save it as a measuring point (see page 50). Saving the position as a measuring point and using a connected GPS receiver (see page 44) will enable the routing of the conduit to subsequently be depicted on a PC.</p>
6	<p>Push the probe a few meters further into the line so that you can still detect its signal and locate it again. If necessary, repeat the process along the remainder of the line's route.</p>

## 5.5 Locating faults and sleeves

### 5.5.1 Locating faults and sleeves using the minimum turbidity method

*Introduction* The minimum turbidity method is suitable for locating the following special features along the cable routing:

- Connecting sleeves
- Junction sleeves
- Wire-to-wire faults
- Wire-to-shield faults
- Sheath faults

This method makes use of the fact that the extremely homogenous electromagnetic field of a live wire generates a very narrow minimum signal directly above the line. If a fault or sleeve is present, this homogenous field is distorted to such an extent that the minimum signal appears wider.

*Procedure* In principle, the iFS receiver is used in much the same way when locating faults and sleeves using the minimum turbidity method as when carrying out a standard line location procedure. It is recommended that you work in either super maximum or minimum mode. In addition, the section of the line in which the fault or sleeve is suspected to be located should be traced as accurately as possible before the actual location procedure. During the actual fault/sleeve location procedure, this section must then be retraced. Whilst doing so, measuring points at suitable intervals must be saved and marked directly above the line (e.g. using paint spray).

As soon as the algorithm identifies a change in the minimum signal strength, indicating a cable fault or a sleeve, the corresponding position is indicated in the measurement series diagram by a significant increase in the thickness of the line.

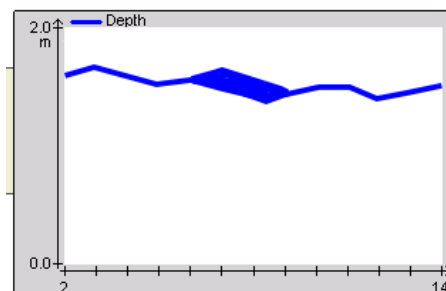

Since the identification of such a change requires comparative values, it is common for the minimum turbidity to only be displayed in the diagram once several additional measuring points have been recorded. In this case, the position of the affected measuring point must be determined using the markings along the route of the line.

### 5.5.2 Locating faults and sleeves using the "Twisted-Field" method

*Introduction* The iFS receiver can be used to measure a longitudinal twist in twisted multicore cables from the surface. The twist is detected due to a constant fluctuation of the signal level when travelling at the same speed along the cable route.

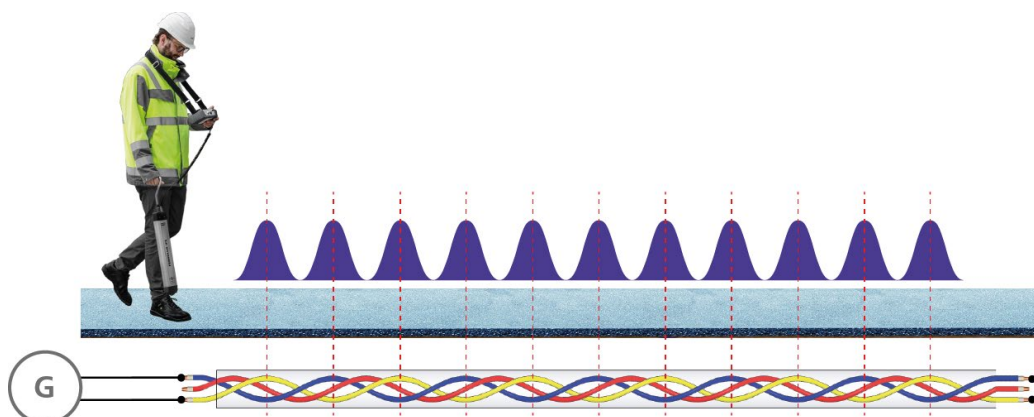

To perform this measurement, the audio frequency signal must be applied to a short-circuited pair of wires and the highest possible current must be set at the generator. For twist measurements, **the depth at which the cable is routed should not be greater than the length of a twist.**

In principle, the longitudinal twist can be measured in maximum or minimum mode. However, since the minimum mode is more susceptible to overlapping from single-core cables routed parallel to the multicore cable, it is preferable to carry out the measurement using maximum mode. The relevant cable section should be traced and marked before the actual fault or sleeve location procedure takes place, as this will allow the route to be retraced more quickly at a later stage.

*Locating low-impedance wire-to-wire faults*

In the case of low-impedance wire-to-wire faults (<10 Ω), the signal must be applied to both of the faulty wires. In such cases, do not short circuit the end of the cable. This is to allow the current to flow directly over the fault. Depending on the location of the fault, there will be either a particularly high or particularly low signal level directly above the fault. The signal is abruptly interrupted once the location of the fault has been passed.

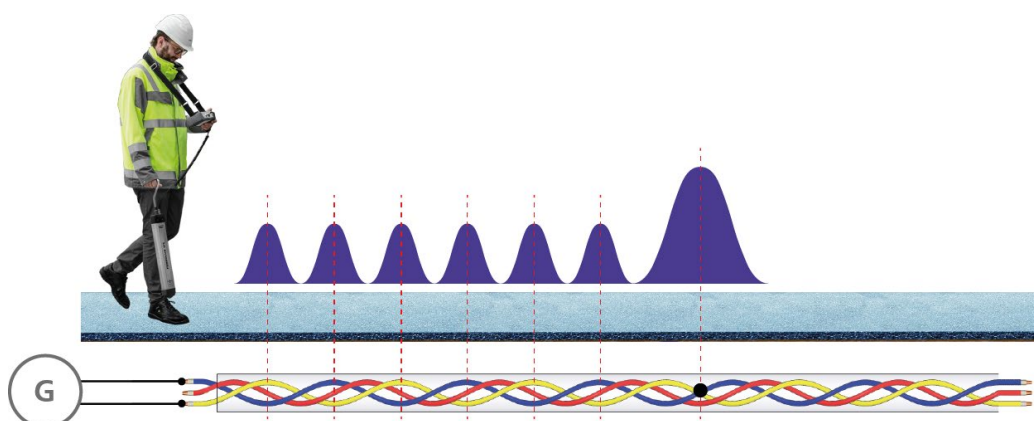

*Locating low-impedance wire-to-shield faults*

In the case of low-impedance wire-to-shield faults (<10 Ω), the signal is applied between the cable shield and a non-faulty wire. At the end of the cable, a low-impedance connection must be established between this non-faulty wire and the faulty wire. The current flows along the shield and the non-faulty wire between the connection point and the location of the fault, which is why a longitudinal twist cannot be measured in this area. This changes as soon as you move beyond the location of the fault. From this position, the current flows along the non-faulty and the faulty wires and a typical longitudinal twist can be measured.

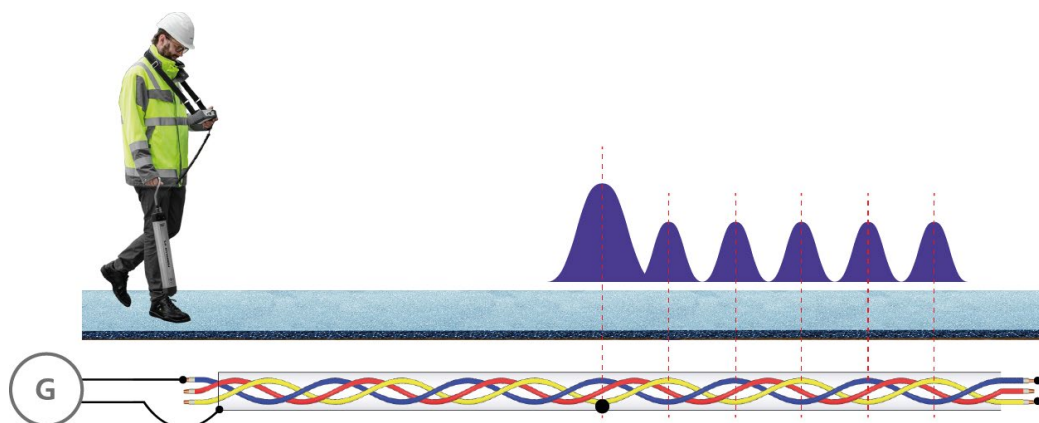

*Locating sleeves*

Since sleeves represent an interruption to the consistent longitudinal twist, the "Twisted-Field" method may be particularly useful for locating longer sleeves. To perform the location procedure, trace the section of cable in which the sleeve is suspected to be located and watch for a short but significant deviation from the usual "level rhythm". The level pattern directly above the sleeve depends on various factors, such as the position of the wires within the sleeve, and does not necessarily correspond to the curve shown below.

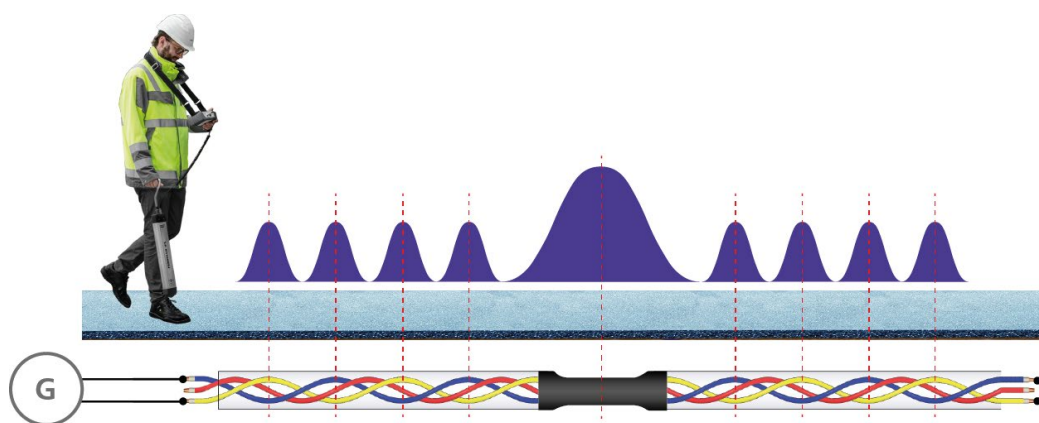

If the sleeve is very small, if the twist is continued inside the sleeve or if the cable is routed deeply, this method is not suitable for reliable positioning.

### 5.6 Cable identification using the reader coil IFA (optional)

*Introduction* Reader coil IFA is used to identify a cable carrying the signal of a connected audio frequency generator within a cluster of several accessible cables (which were exposed due to excavation work, for example).

When the reader coil is connected, the display unit starts in Ferrolux mode. However, the screen display differs from the actual cable location mode (see page 41) in that the elements relevant for finding the line (direction arrows, line orientation) are not displayed. The strength of current and the depth are also not displayed when measuring using the reader coil.

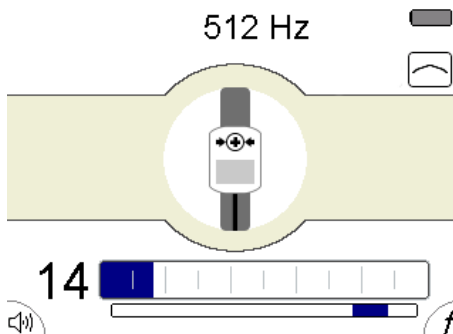

*Basic use* The reader coil is applied directly on the cable for the purposes of measurement, with the curved base of the reader coil in contact with the cable. To ensure that the SignalSelect display (see page 57) clearly identifies the target line with ⊕, it must be ensured that the →⊕← symbol on the top side of the coil and the arrow on the bottom side is pointing in the direction of the current flow (i.e. away from the transmitter).

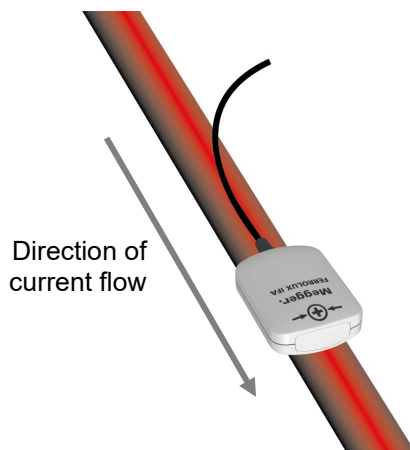

**Reading methods** In order to reliably read the target cable among a cluster of lines in close proximity to each other, a SignalSelect-coded signal should be applied to the cable.

A good method for coupling signals is to use a transmitter clamp, which must also be compatible with SignalSelect. One advantage of using a transmitter clamp is that the connected consumers do not have to be isolated. Ensure that the transmitter clamp is placed around the shield and the inner conductors of the cable to be read out. This cable can then be reliably identified using the SignalSelect display during the actual reading process, as either a return signal or no signal at all will be measured from all other cables.

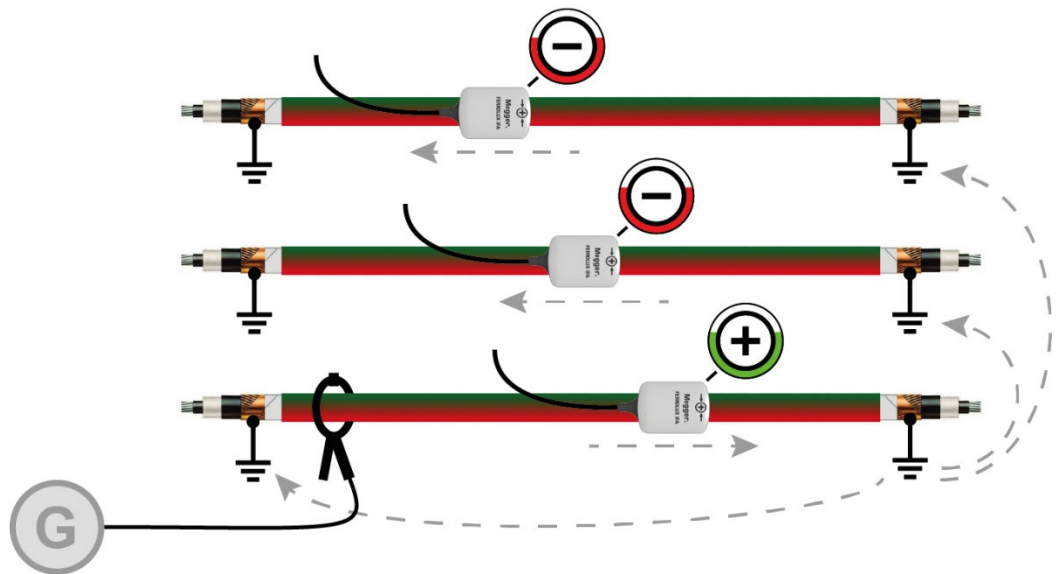

If it is not possible to couple the signals using a clamp, it is recommended to connect the transmitter directly to the cable shield. For this method, the cable shield must not be earthed on the connection side.

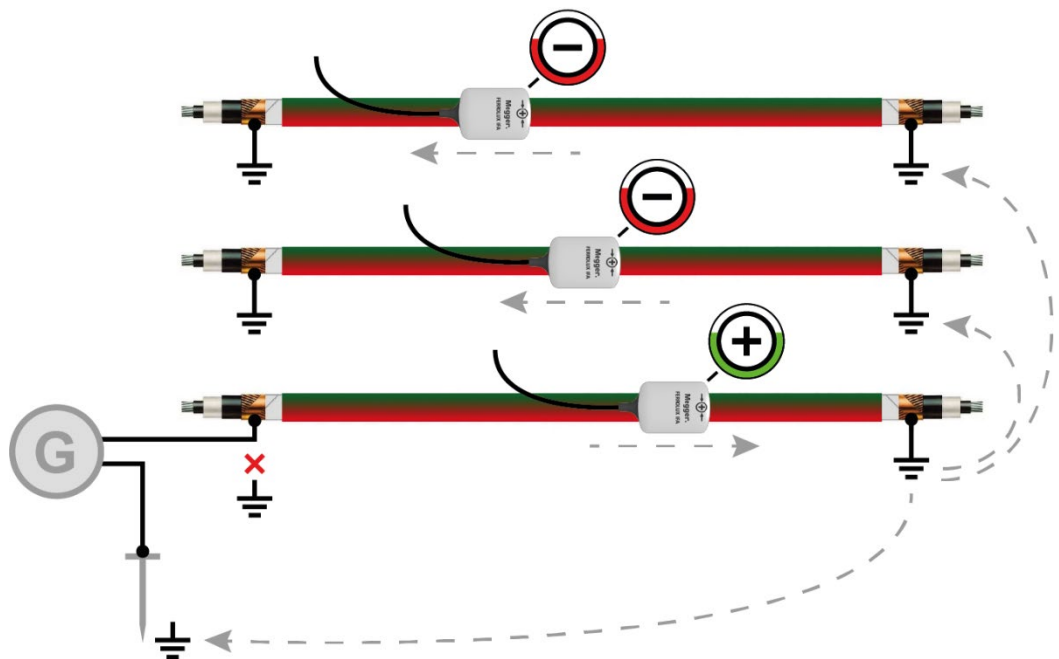

If it is not possible to couple a SignalSelect-coded signal, use the “Twisted-Field” method described previously for twisted multicore cables. To do this, the audio frequency signal must be applied to a short-circuited pair of wires.

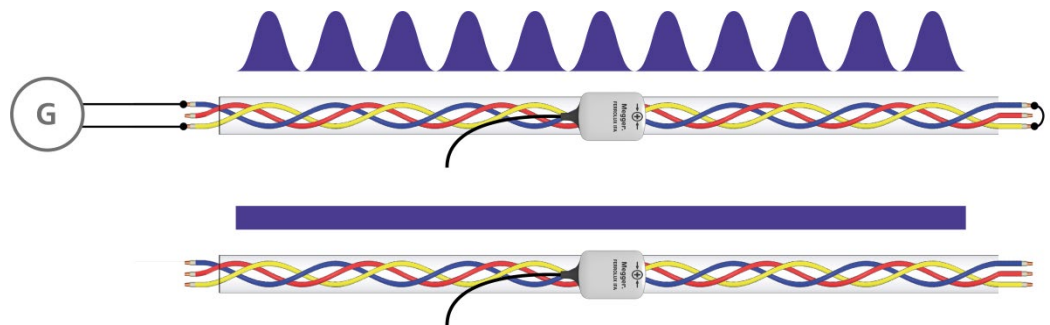

A consistent change in signal level will be measured from the inductively coupled cable, whereas the signal response from the neighbouring lines will remain relatively constant.

## 5.7 Switching off the indicator unit

After successful location of the cable or fault, the indicator unit can be switched off with a **long press** of the  button.

## 6 Pinpointing Sheath Faults in „ESG“ Mode

### 6.1 Preparatory Measures

#### 6.1.1 Tracing the Line

Trace the route of the faulty cable as exactly as possible in the pre-located area using a line location device. Knowledge of the exact cable route makes it far easier to pinpoint the sheath fault.

#### 6.1.2 Starting Up the DC Impulse Generator



To pinpoint a sheath fault, a DC impulse generator is needed. When equipment creating such high voltages is used, certain safety regulations must be complied with. It is essential to read the manual for the DC impulse generator!

For a DC impulse generator, any equipment and system can be used which can be prepared for pulsed DC voltage to locate sheath faults. This particularly includes equipment from the MFM series, but also various other testing and fault location systems.

Connect the DC impulse generator to the screen of the faulty cable and generate a pulsed DC voltage permissible for the type of sheath.

For more details about starting up the device, please read the accompanying instructions.

### 6.1.3 Connecting the Earth Spikes

 <b>CAUTION</b>	The cables supplied with the unit may only be used in accordance with their intended purpose, which is to connect the earth spikes to the indicator unit!
---	---

 <b>CAUTION</b>	<b>Hold the earth spikes by the insulated handles only</b> In the immediate vicinity of the potential gradient dangerous voltages may occur at the surface. The displayed voltage values are not suitable to draw a conclusion about the actual risk.
---	--

When connecting the earth spikes, observe the designated colours of the connection cable and connection socket!

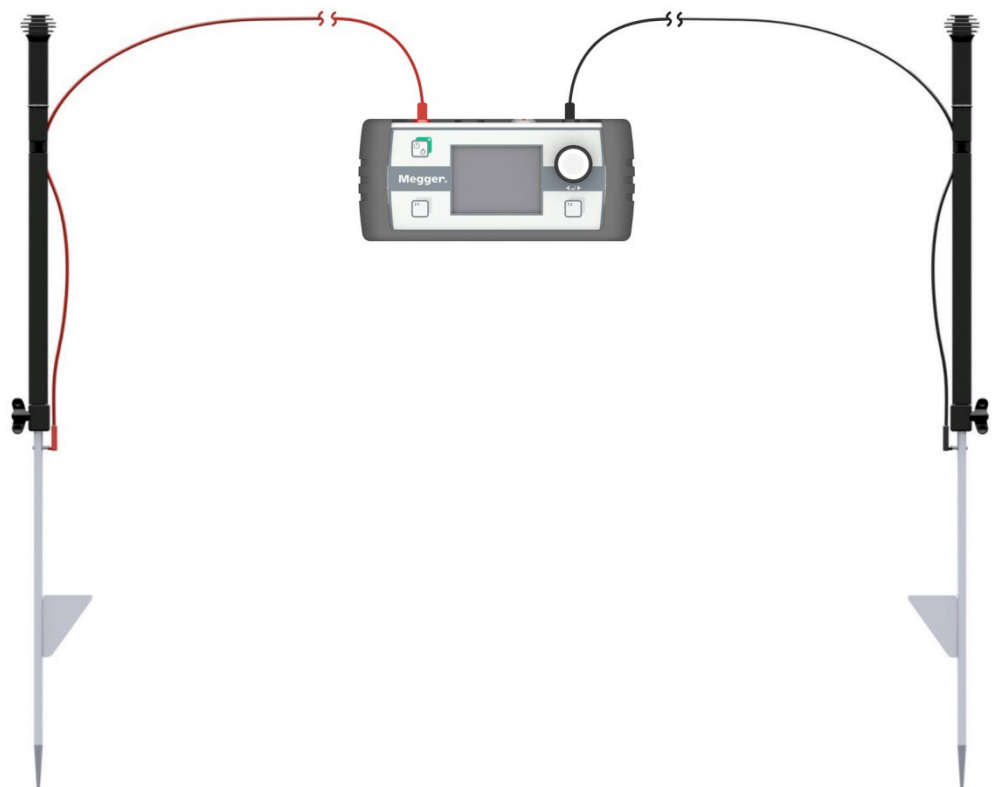

To avoid switching back and forth or even accidentally pulling out the cable while operating, it is advisable to attach the cable to the earth spike as shown in the diagram:

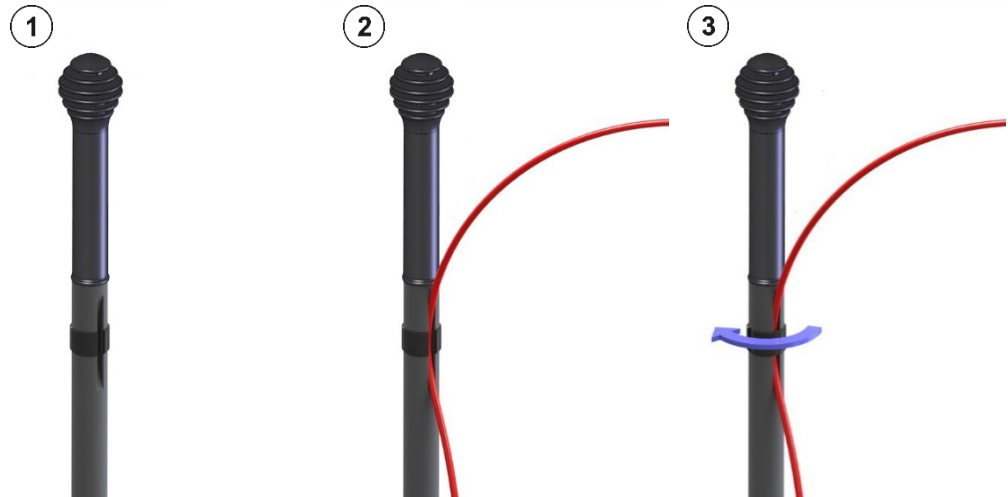

In applications in which it was only possible to pre-locate the fault position very vaguely, or even where it was not possible at all, you will have to approach the position from a greater distance. However, to be able to measure the smaller step voltage, the earth spikes need to be placed at larger intervals from one another (see page 84). For this purpose, customised connection cables of 15 metres in length are available as accessories.

### 6.1.4 Turning On the Indicator Unit

*Turning on* Once the earth spikes are connected to the indicator unit, press the button briefly to switch on. The software automatically detects the connected earth spikes and starts the correct operation mode.

Shortly after switching on, the **measurement screen** appears. The device is now ready to measure.

*Layout of the measurement screen* While you are pinpointing, the **measurement screen** displays all the relevant information which could be useful when approaching the sheath fault:

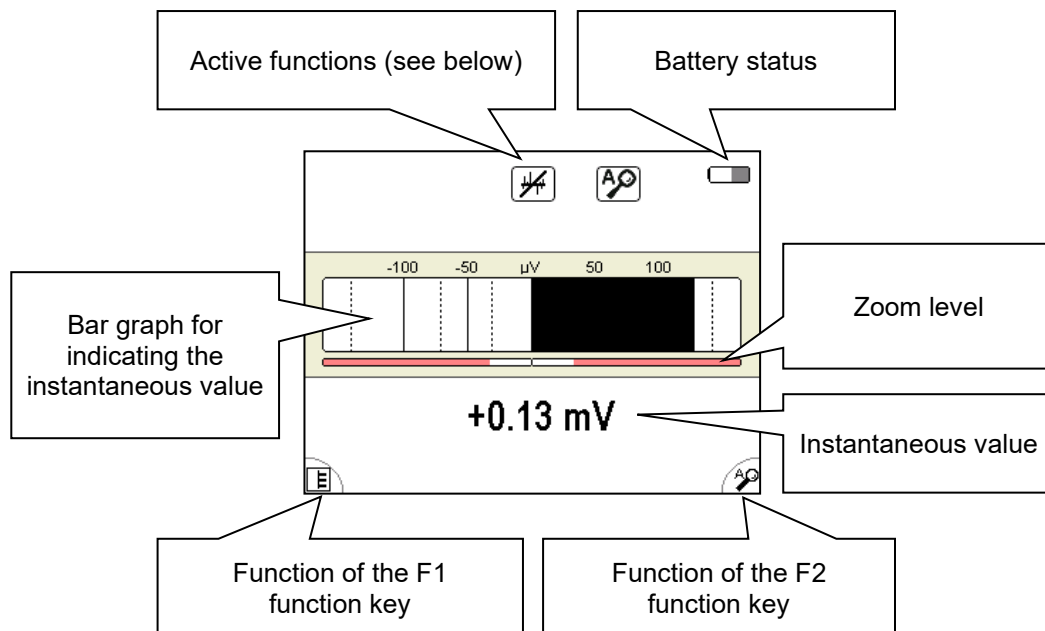

*Active functions and modes* The symbols at the top right of the measurement screen indicate the following functions and measurement modes:

Symbol	Description
	High pass filtering is active (see page 81)
	Smoothing filter is active (see page 81)
	Automatic zoom is active (see page 81)
	50/60 Hz location mode is active (see page 81)

*Alternative view* In addition to the standard view, the device offers an alternative view for showing the time progress of the step voltage over 16 seconds.

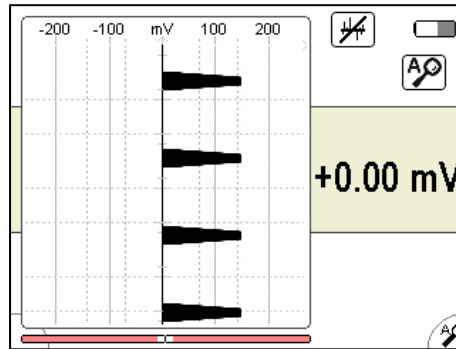

This alternative display can be activated or deactivated at any time via the **E** menu item (see page 81).

### 6.1.5 Adjusting the Settings

*Menu structure* You can switch from the **measurement screen** to the **menu screen** at any time and change any settings in two steps at most:

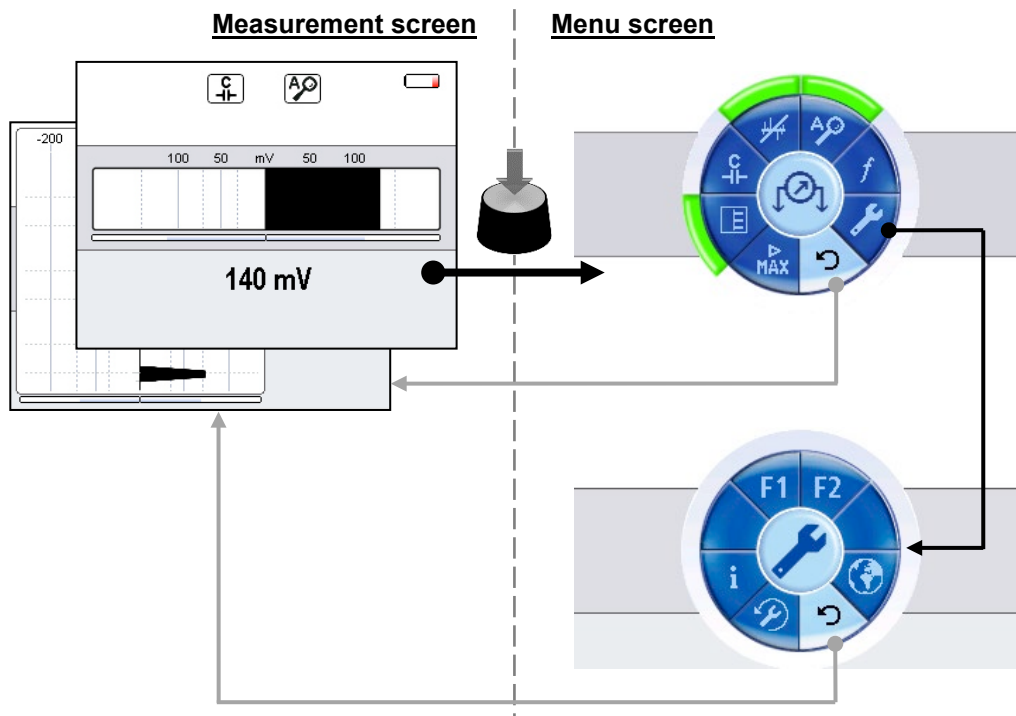

*Layout of the menu screens* Each **menu screen** is made up as follows:

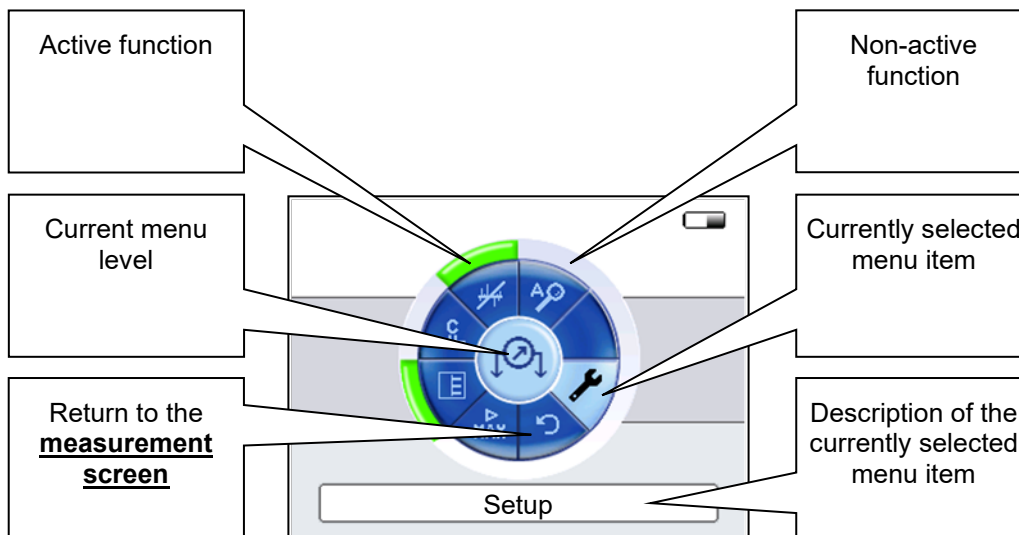







### 6.1.5.1 Adjusting the Basic Settings

After the indicator unit has been switched on, you can adjust the basic settings. To do so, switch to the **menu screen** by pressing the knob and selecting the menu item . The following menu then appears in the display:



In this menu you can perform the following basic settings:

Menu item	Description
F1   F2	Using this menu item, the following functions can be assigned to the two function keys of the indicator unit: <ul style="list-style-type: none"> <li> Each press of the function key switches between the two measurement screens.</li> <li> The high pass filtering (see next section) can be activated/deactivated by pressing the function key.</li> <li> The smoothing filter (see next section) can be activated/deactivated by pressing the function key.</li> <li> The automatic zoom (see next section) can be activated/deactivated by pressing the function key.</li> </ul>
	Sets the display language.
	Restores the factory settings.
<b>i</b>	Shows the current software version of the indicator unit.

### 6.1.5.2 Adjusting the Measurement Settings

By pressing the knob, you can at any time switch from the measurement screen to the menu screen with the most important measurement settings:



In this menu you can perform the following measurement settings:

Menu item	Description
	Activating/deactivating the alternative measurement screen (see page 77) with a display for the time progress of the voltage.
	<p>Activating/deactivating the automatic zoom.</p> <p>If this function is active, the scale of the voltage display automatically adapts to the current measurements all the time. The knob does not have a function in this case.</p> <p>If the function is deactivated, the scale needs to be adjusted manually by turning the knob.</p> <p>The currently set zoom level is permanently displayed in a small bar below the bar graph or diagram (see page 77).</p>
	<p>Switch between the available measurement modes.</p> <p> Pre-set and preferred mode for pinpointing sheath faults in combination with a DC voltage generator that feeds a pulsed DC voltage into the faulty cable.</p> <p><b>50/60</b> Alternative mode for pinpointing cable faults on live low-voltage cables.</p> <p>Depending on the mains frequency, the appropriate setting must be selected.</p> <p>This mode can be particularly useful, for example, when the building junction boxes are inaccessible and the consumers cannot be easily disconnected from the mains.</p>

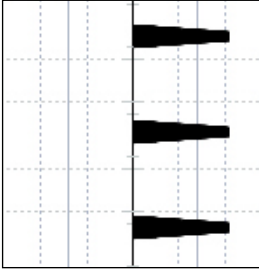
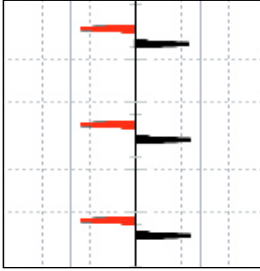
Menu item	Description
<p style="text-align: center;">C - +</p>	<p>Activating/deactivating the high pass filtering.</p> <p>Select this function if severe interference affects the measurements (such as in the vicinity of tram installations).</p> <p>The high pass filter suppresses any constant components, whereby only the edges are displayed but not the impulse itself.</p> <p>This is why the device has different indications with active high pass filtering. Each DC pulse causes two deflections at different polarity, where the first indicates the start of the impulse and the second indicates the end. The first deflection indicates the direction of the fault position.</p> <div style="display: flex; justify-content: space-around; align-items: flex-start;"> <div style="text-align: center;"> <p><b>without high pass filtering</b></p>  </div> <div style="text-align: center;"> <p><b>with high pass filtering</b></p>  </div> </div>
<p style="text-align: center;"><del>≡</del></p>	<p>Activates/deactivates the smoothing filter.</p> <p>When the smoothing filter is activated, sudden signal peaks which are not part of the actual signal are suppressed.</p>
<p style="text-align: center;">▷ MAX</p>	<p>Activates/deactivates the maximum sensitivity.</p> <p>By default, the sensitivity of the volt meter is limited to measurement values &gt;1 mV. In this way, low interference signals are ignored by the system and unnecessary adjustments of scaling are avoided.</p> <p>If it becomes necessary to begin fault location at a greater distance from the sheath fault, the useful signal in certain circumstances is barely above noise level. In these situations the maximum sensitivity should be activated and the measurement range be expanded downwards to 5 μV.</p>

## 6.2 Approaching the Fault

### 6.2.1 General Notes

*Technical principles* With each coupled DC pulse, current flows into the ground at the position of the fault, which forms voltage gradients around the fault position.

The step voltage, which can be measured on the surface, increases at the fault position and changes polarity directly above the location.

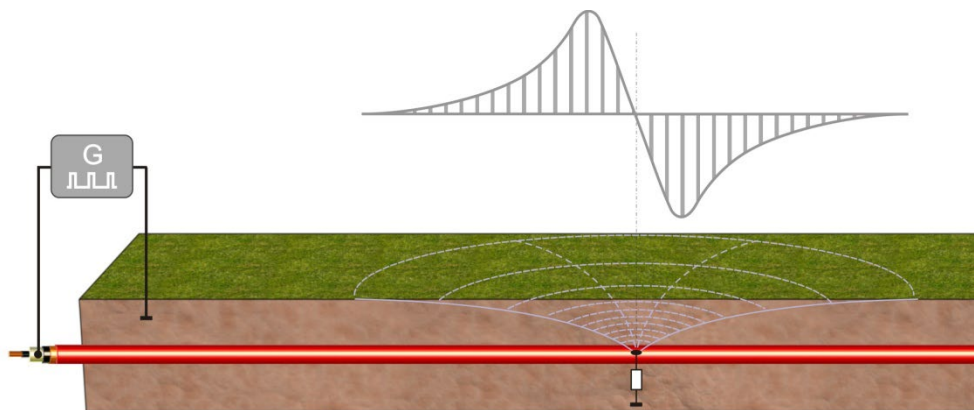

This particular effect is most beneficial for pinpointing sheath faults, by measuring the value as well as the polarity of the step voltage using two earth spikes and approaching the deflection direction following the fault position.



- The sheath fault is located in the direction of the earth spike which is connected with the black measuring lead
- The sheath fault is located in the direction of the earth spike which is connected with the red measuring lead

*Orientation* To ensure a reliable indication of the direction, note the following guidelines for basic handling:

- The earth spikes should be placed along the suspected cable route if possible.
- The indicator unit must be kept in a horizontal position along the cable run.
- While approaching the fault location, the earth spikes must not get mixed up and the alignment of the indicator unit must not change.**

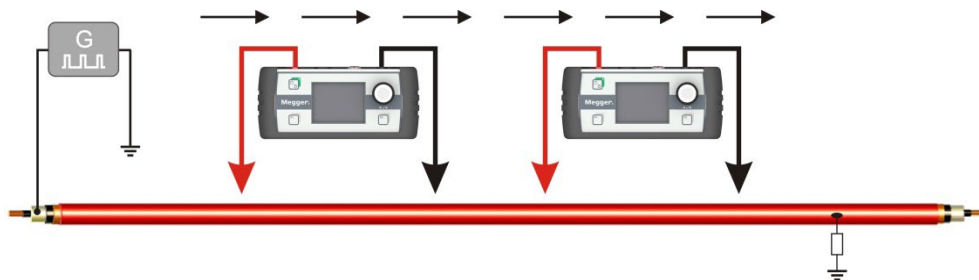

**Distance between the earth spikes** The distance between the earth spikes directly affects the step voltage reading. If the distance increases, the potential difference between the two earth spikes rises and therefore the voltage reading shown on the indicator unit as well.

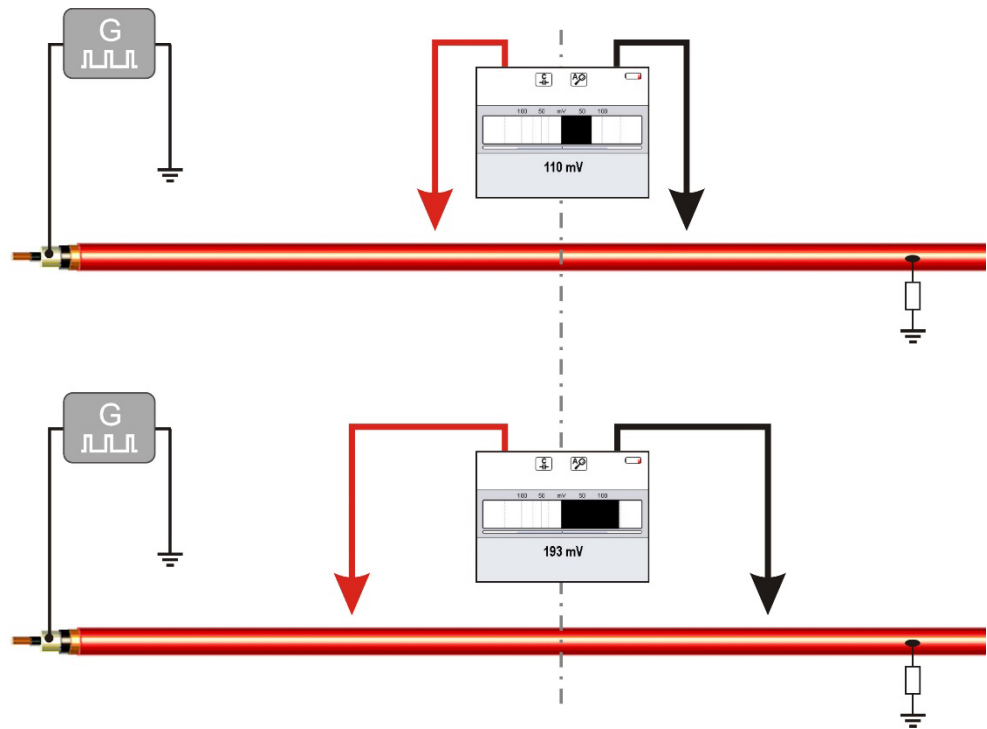

Particularly when you start pinpointing, it is advisable to place the earth spikes at larger distances from each other so that the generator impulse can be identified as clearly as possible, even at greater distances to the fault location.

---



---

**i** If, for example, precise pre-location was not possible due to multiple faults, the maximum possible distance is sometimes not enough to measure the impulses due to the connection cables. In this case, a connection cable (or both, in extreme cases) can be replaced with a longer one. This would require a second person to speed up the work!

---



---

**Impact of ground conditions** The ground conditions have a huge effect on the electrical coupling and the precision of the system.

Changing coupling behaviour while pinpointing can, for instance, cause the measured voltage to drop even when approaching the fault position.

Dry asphalt ground acts as an insulator and does not provide sufficient earth contact for the earth spikes. In this case pinpointing can also be performed in parallel to the cable route on more suitable ground, as the voltage gradients do also spread to the side.

In densely built-up urban areas, the gaps between the ground and paving stones can also be used to attach the earth spikes.

If none of the above alternatives is feasible, the earth contact may be improved by means of the included sponge. For this, the sponge have to be moistened first and then stuck to the pointy end of the earth spikes.

### 6.2.2 Procedure

*Diagram* In the following picture you can see several points of an ideal signal route from the feeding point to the fault position and beyond:

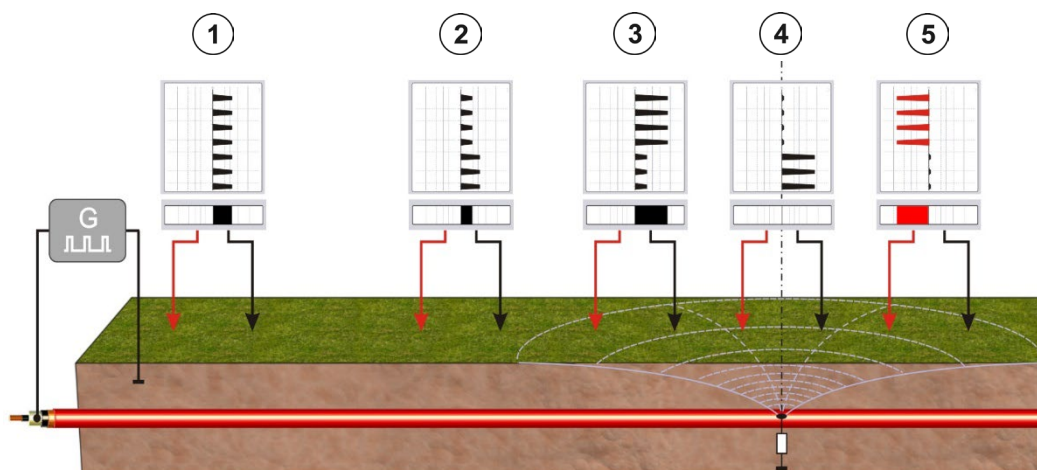

As voltage gradients induced by the current flowing back from the fault position exist around the earthing point of the generator, the measurement values near this point might be elevated (position ①). However, the deflection direction (polarity) also indicates the direction of the fault position at this point.

At half-way point between the generator and the fault position, the signal strength reaches a minimum (position ②). On moving nearer to the fault (position ③), the signal strength increases again. The maximum signal strength is measured when one of the earth spikes is directly above the fault.

If the fault is exactly between the two earth spikes or exactly to the side (position ④), the indicator unit does not display a reading.

If the fault position is passed by, the polarity changes (position ⑤). The signal on the indicator unit points to the other direction.

*Procedure* This is what to do when approaching the fault:

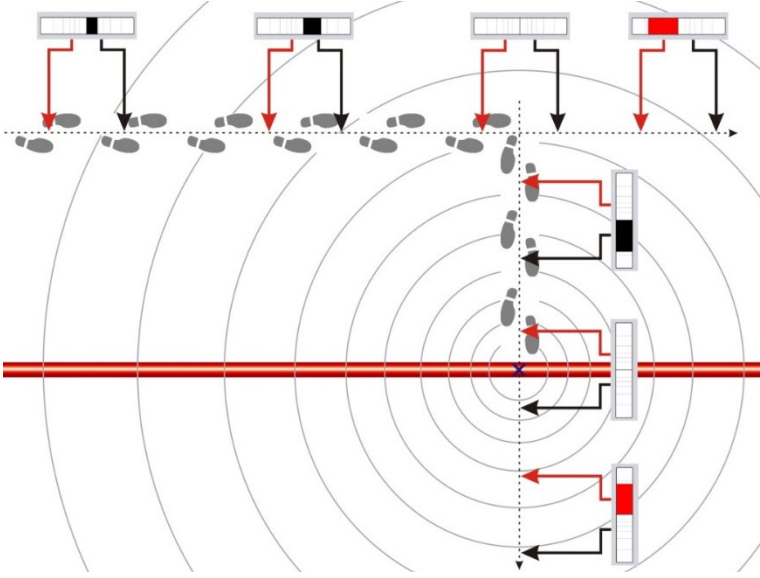
Step	Action
1	Find a suitable place to start on the ground directly above the traced cable route or to the side. Insert the two earth spikes in the correct alignment positions (see page 83) into the ground.
2	<p>Observe the signals on the indicator unit and try to identify the impulse signal of the generator.</p> <ul style="list-style-type: none"> <li>Adjust the scale of the display to the signal level by turning the knob or activate the automatic scaling (see page 81).</li> <li>If necessary, increase the distance between the earth spikes to receive a stronger signal level.</li> <li>If the DC impulse of the generator is masked by interference, try to counter the interference by using some of the available filter functions (see page 82).</li> <li>Switching to the alternative view which shows the voltage curve over the last 16 seconds (see page 81) could make identifying the periodical DC voltage impulses easier.</li> </ul>
3	<p>Follow the cable route in the direction of the signal without changing your orientation. Take some more measurements every few metres.</p> <p>When approaching the fault position, the distance between the earth spikes can be gradually decreased by up to about one metre with increasing signal levels. Continue approaching until the signal suddenly changes its polarity and indicates the opposite direction.</p>
4	Go back slightly and measure the signal level at smaller intervals. Determine the position at which the opposing currents compensate each other and at which there is no signal level indicated.
5	<p>To correct any possible lateral offset, insert the two earth spikes at an angle of 90° to the cable route and determine the zero point for the second coordinate by further measurements.</p> 

Step	Action
6	<p>Place the black earth spike on the suspected position of the fault and the red earth spike about one metre away. The signal must now point in the direction of the black earth spike. Repeat this control measurement at several other positions in a circle around the black earth spike.</p> <div data-bbox="715 439 1251 808" data-label="Diagram"> </div> <p>If the signal level indicates towards the black earth spike at each control measurement, the fault position has been successfully verified.</p>
7	Repair the damaged section and test the sheath again for any further damage.

### 6.3 Completing the Work

After the sheath fault has been successfully pinpointed, the indicator unit can be turned off by pressing the  button **for 3 seconds**.

Afterwards, the DC impulse generator can be switched off and disconnected from the cable under test while making sure that all applicable safety regulations are followed.

## 7 Pairing with Bluetooth accessories

*Introduction* The indicator unit has a built-in Bluetooth module and can be paired with the following Bluetooth accessories:

**Headphones** Bluetooth headphones that support at least Bluetooth 3.0 and AD2P. A suitable model can be ordered as an accessory (see page 12).





**GPS receiver** With the help of a coupled GPS receiver, the current GPS coordinates can be shown in the display during the ongoing measurement. In Ferrolux mode, the GPS coordinates are also stored in the measurement series so that the line route can be tracked later on the PC. A suitable GPS receiver can be ordered as an accessory (see page 12). Other models are not supported.

Only one Bluetooth connection can be established at any one time. It is therefore not possible to pair headphones and the GPS receiver at the same time.

To activate/deactivate the Bluetooth module, to connect a known device or to pair new devices, it is only necessary to call up the menu screen and select the menu item  (not available in ESG mode):



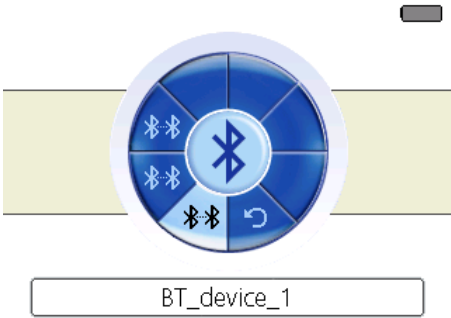





*Perform initial pairing* To pair a device with the display unit for the first time, follow these steps:

Step	Action
1	Ensure that the Bluetooth device you are pairing is switched on and visible to other Bluetooth devices. Headphones usually have to be switched to pairing mode.
2	Activate the Bluetooth module of the display unit via menu item  .
3	<p>Use menu item  to start the search for available devices.</p> <p><b>Result:</b> The indicator unit returns to the measurement screen and searches for visible Bluetooth devices for about 30 seconds. The current search is indicated by the flashing  symbol.</p> <p>When the search is complete, the list of devices found is displayed.</p> <div data-bbox="762 745 1214 1061" style="text-align: center;">  </div>
4	<p>Use the rotary knob to find the correct device based on the identifier and press the rotary knob to pair.</p> <p><b>Result:</b> After successful pairing, the existing Bluetooth connection is indicated in the measurement screen with the symbol  (if headphones are connected) or  (if a GPS receiver is connected).</p>

*Establishing a Bluetooth connection to a known device*

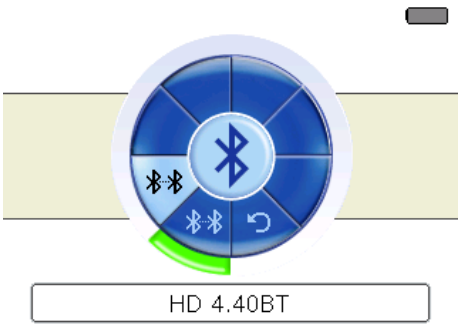
If the headset or GPS receiver is switched on and the internal Bluetooth module is active, the connection to a known Bluetooth device is normally established automatically within a few seconds after the display unit is switched on.

If this does not work or if the display unit is connected to the wrong device, proceed as follows:

Step	Action
1	Ensure the Bluetooth device is switched on.
2	Activate the Bluetooth module of the display unit via menu item  .
3	Use menu item  to call up the list of known devices.  <b>Result:</b> The list of known devices is displayed. If one of the devices is currently connected to the display unit, it is highlighted in green.  
4	Use the rotary knob to find the correct device based on the identifier and press the rotary knob to establish a connection.  <b>Result:</b> The display unit switches to the measurement screen and attempts to connect to the selected device. This is indicated by the flashing  symbol. After successful pairing, the existing Bluetooth connection is indicated in the measurement screen with the symbol  (if the headphones are connected) or  (if the GPS receiver is connected).

## 8 GPS data export and firmware update

*Introduction* Multi-functional PC software is available with the Ferrolux/Digiphone management software that can be used for the following application purposes:

- Exporting of the tracing measurement series
- Firmware upgrade for the indicator unit
- Firmware upgrade at various sensors (IFS, DPP-SU)

The latest version of the software can be downloaded from the product page on the Megger website.

In order to install and use the software, your system must fulfil the following requirements:

- Operating system: 64 Bit, Windows 7 or later
- Processor: Intel i5 or higher
- RAM: min. 4 GB
- Interfaces: USB 2.0

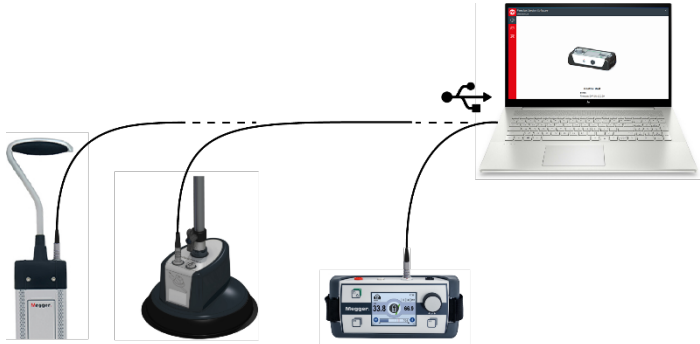
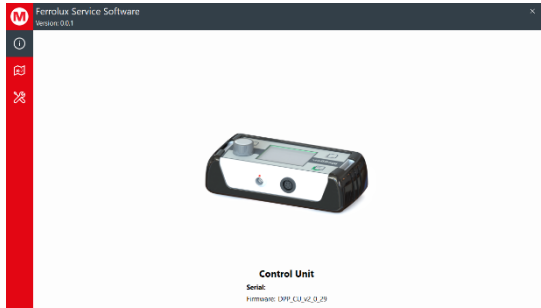

*Making a connection* Proceed as follows to establish a connection between the indicator unit / the sensor and the software:

Step	Action
1	<p>Connect the indicator unit or the sensor via the connection cable available as a special accessory (see page 12) to the USB interface of the PC.</p> 
2	Switch on the indicator unit (not necessary with a sensor).
3	<p>Start the software.</p> <p><b>Result:</b> The software should detect the connected device shortly after starting, and display it on the main screen as confirmation.</p> 

## 8.1 Exporting and deleting measurement series from the indicator unit

*Exporting measurement series*

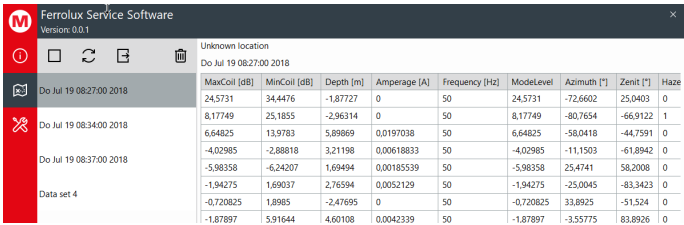
Proceed as follows to export measurement series from the indicator unit to the PC:

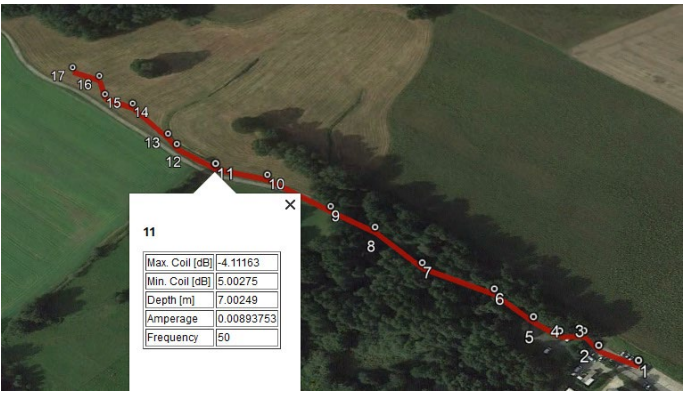
Step	Action																																																																																		
1	<p>Click on the  icon in menu bar on the left.</p> <p><b>Result:</b> The measurement series stored on the device are displayed.</p>  <table border="1"> <thead> <tr> <th>Do Jul 19 08:27:00 2018</th> <th>MaxCoil [dB]</th> <th>MinCoil [dB]</th> <th>Depth [m]</th> <th>Amperage [A]</th> <th>Frequency [Hz]</th> <th>ModelLevel</th> <th>Azimuth [°]</th> <th>Zenit [°]</th> <th>Haze</th> </tr> </thead> <tbody> <tr><td>24.5731</td><td>34.4476</td><td>-1.87727</td><td>0</td><td>50</td><td>24.5731</td><td>-72.6602</td><td>25.0403</td><td>0</td></tr> <tr><td>8.17749</td><td>25.1855</td><td>-2.96314</td><td>0</td><td>50</td><td>8.17749</td><td>-80.7654</td><td>-66.9122</td><td>1</td></tr> <tr><td>6.64825</td><td>13.9783</td><td>5.89869</td><td>0.0197038</td><td>50</td><td>6.64825</td><td>-58.0418</td><td>-44.7591</td><td>0</td></tr> <tr><td>-4.02985</td><td>-2.88818</td><td>3.21198</td><td>0.00618833</td><td>50</td><td>-4.02985</td><td>-11.1503</td><td>-61.8942</td><td>0</td></tr> <tr><td>-5.98358</td><td>-6.24207</td><td>1.69494</td><td>0.00185539</td><td>50</td><td>-5.98358</td><td>25.4741</td><td>58.2008</td><td>0</td></tr> <tr><td>-1.94275</td><td>1.69037</td><td>2.76594</td><td>0.0052129</td><td>50</td><td>-1.94275</td><td>-25.0045</td><td>-83.3423</td><td>0</td></tr> <tr><td>-0.720825</td><td>1.8985</td><td>-2.47695</td><td>0</td><td>50</td><td>-0.720825</td><td>33.8925</td><td>-51.524</td><td>0</td></tr> <tr><td>-1.87897</td><td>5.91644</td><td>4.60108</td><td>0.0042339</td><td>50</td><td>-1.87897</td><td>-3.55775</td><td>83.8926</td><td>0</td></tr> </tbody> </table>	Do Jul 19 08:27:00 2018	MaxCoil [dB]	MinCoil [dB]	Depth [m]	Amperage [A]	Frequency [Hz]	ModelLevel	Azimuth [°]	Zenit [°]	Haze	24.5731	34.4476	-1.87727	0	50	24.5731	-72.6602	25.0403	0	8.17749	25.1855	-2.96314	0	50	8.17749	-80.7654	-66.9122	1	6.64825	13.9783	5.89869	0.0197038	50	6.64825	-58.0418	-44.7591	0	-4.02985	-2.88818	3.21198	0.00618833	50	-4.02985	-11.1503	-61.8942	0	-5.98358	-6.24207	1.69494	0.00185539	50	-5.98358	25.4741	58.2008	0	-1.94275	1.69037	2.76594	0.0052129	50	-1.94275	-25.0045	-83.3423	0	-0.720825	1.8985	-2.47695	0	50	-0.720825	33.8925	-51.524	0	-1.87897	5.91644	4.60108	0.0042339	50	-1.87897	-3.55775	83.8926	0
Do Jul 19 08:27:00 2018	MaxCoil [dB]	MinCoil [dB]	Depth [m]	Amperage [A]	Frequency [Hz]	ModelLevel	Azimuth [°]	Zenit [°]	Haze																																																																										
24.5731	34.4476	-1.87727	0	50	24.5731	-72.6602	25.0403	0																																																																											
8.17749	25.1855	-2.96314	0	50	8.17749	-80.7654	-66.9122	1																																																																											
6.64825	13.9783	5.89869	0.0197038	50	6.64825	-58.0418	-44.7591	0																																																																											
-4.02985	-2.88818	3.21198	0.00618833	50	-4.02985	-11.1503	-61.8942	0																																																																											
-5.98358	-6.24207	1.69494	0.00185539	50	-5.98358	25.4741	58.2008	0																																																																											
-1.94275	1.69037	2.76594	0.0052129	50	-1.94275	-25.0045	-83.3423	0																																																																											
-0.720825	1.8985	-2.47695	0	50	-0.720825	33.8925	-51.524	0																																																																											
-1.87897	5.91644	4.60108	0.0042339	50	-1.87897	-3.55775	83.8926	0																																																																											
2	<p>Click the measurement series you want to export in order to select them. To mark multiple measurement series, hold down the Ctrl key.</p> <p>Or you can mark all the measurement series displayed with a single click using the <input type="checkbox"/> button above the measurement series list.</p>																																																																																		
3	Click on  to export the marked measurement series.																																																																																		
4	Save the file in the required folder and under the required name.																																																																																		
5	<p>The exported measurement series can be imported in a suitable application for displaying KML files and displayed there. The measurements recorded at the individual measurement points also can be reproduced in this way if this is supported by the application that is used (example image from Google Earth).</p>  <table border="1"> <thead> <tr> <th>Max. Coil [dB]</th> <th>Min. Coil [dB]</th> <th>Depth [m]</th> <th>Amperage</th> <th>Frequency</th> </tr> </thead> <tbody> <tr> <td>-4.11163</td> <td>5.00275</td> <td>7.00249</td> <td>0.00893753</td> <td>50</td> </tr> </tbody> </table>	Max. Coil [dB]	Min. Coil [dB]	Depth [m]	Amperage	Frequency	-4.11163	5.00275	7.00249	0.00893753	50																																																																								
Max. Coil [dB]	Min. Coil [dB]	Depth [m]	Amperage	Frequency																																																																															
-4.11163	5.00275	7.00249	0.00893753	50																																																																															

*Delete measurement series* This is how to delete measurement series from the internal memory of the indicator unit:

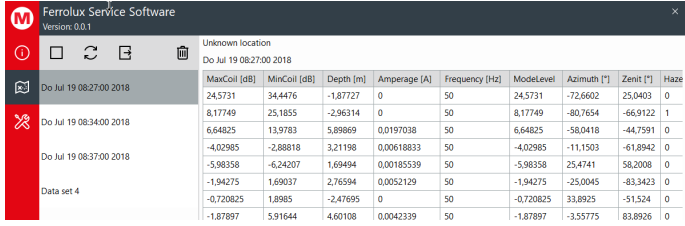
Step	Action
1	<p>Click on the  icon in menu bar on the left.</p> <p><b>Result:</b> The measurement series stored on the device are displayed.</p> 
2	<p>Click on  to delete all of the displayed measurement series from the indicator unit.</p> <p>The deletion of individual measurement series is not possible.</p>
3	<p>Confirm the confirmation prompt.</p>

## 8.2 Updating the firmware

Proceed as follows to update the firmware of the indicator unit or a sensor:

Step	Action
1	<p>Click on the  icon in menu bar on the left.</p>
2	<p>Click on  and select the relevant firmware file.</p> <p><b>Result:</b> The software automatically checks whether the firmware file is appropriate for the connected hardware, and only enables the button for starting the firmware update, if this is the case.</p>
3	<p>Click on <b>Update Firmware</b> to start the firmware update.</p> <p>Do not switch off or disconnect the device during the updating procedure!</p>

## **9 Storage and Transport**

*Long periods out of use and storage* If you do not expect to use the unit for over a month, you must remove the batteries and store them separately.

You should store the device in a dry and sheltered environment which provides adequate protection against mechanical damage and dirt. The storage temperatures shown in the technical data must be adhered to.

*Transport* Only use the carry-bag supplied to transport the device. Please note that the ambient conditions along the entire transport route must comply with the technical data.

During transport, never hold the device by the connection cables only!

## 10 Maintenance and Care

**Changing the batteries** To change the 6 x 1.5 V AA batteries, you must undo the two screws on the underside of the indicator unit by a quarter of a turn (e.g. using a coin) and then take off the battery compartment cover.

NiMH rechargeable batteries (AA type) can also be placed in the battery compartment. However, they must be charged using an external charger.

**Caring for the display** Do not clean the display with aggressive products such as solvents or spirits.

Instead, use lukewarm water and a soft, lint-free cloth for wet wiping, or a microfibre cloth for dry wiping.

**Lock of the DPP-SU telescopic handle** After a few years of intensive use, the quarter turn lock of the DPP-SU telescopic handle can show signs of wear and tear which will lead to a worsening of the support for the sensor.

If this is the case, you can either send the telescopic handle to an authorised service centre, or you could order a quarter turn lock as a replacement part (article number: 128309580) and carry out the replacement yourself.

If you choose to carry out the repair independently, you must first loosen the union nut **1** at the lower end of the handle by using a spanner with a rim width of 22 mm. A hot air blower may have to be used to loosen the hardened screw locking agent. After that has been done, the quarter turn lock **2** may be removed and replaced.

Before being re-assembled, the thread **3** of the telescopic handle should be moistened with a liquid thread locker (medium strength; e.g. Loctite 243). To align the lock correctly and to secure it against rotation, the slit at the head of the quarter turn lock must engage with the guide link **4**.

