

User Manual



English

CONTENTS

GENERAL INFORMATION

New, continue and save	7
Finalize	8
Filter	8
File manager	9
Report Overview	14
Settings	16
Update System	22
Easy-Laser PLUS	23
Cleaning of optical windows	26

DISPLAY UNITS

XT12 Startscreen	27
XT12 Battery Status and charging	28
XT11 Startscreen	29
XT11 Info display	30
XT11 Charging	31
XT Display Unit Camera	32
XT Display Unit IR camera	33
XT Display Unit Screenshot	35

MEASURING UNITS

Select measuring units	37
XT40	40
XT50	43
XT60	46
XT70	48

VALUES

Overview	51
Connect	53
Measure	55
Autorecord	60
Result	62
Report	64
Calibration check	65

EASYTREND

Overview EasyTrend	67
DM bracket	68
Prepare	69
Measure	70
Easy Trend Report	71

HORIZONTAL

Overview Horizontal	73
Prepare	75

Measure using EasyTurn™	85
Measure using 9-12-3	87
Measure using Multipoint	89
Measure using Continuous sweep	91
Measure using Uncoupled sweep	93
Softfoot	95
Result	96
Adjust	104
Adjustment Guide	107
Horizontal Report	108

MACHINE TRAIN

Overview Machine Train	109
Prepare	110
Measure using EasyTurn™	119
Measure using 9-12-3	121
Measure using Multipoint	123
Measure using Continuous sweep	125
Measure using Uncoupled sweep	127
Manual entry	129
Softfoot	130
Result	131
Adjust Machine Train	138
Machine train Report	141

VERTICAL

Overview Vertical	143
Prepare	144
Measure	148
Result	149
Adjust	151
Vertical Report	153

CARDAN

Overview Cardan	155
Prepare	156
Measure using EasyTurn™	162
Measure using 9-12-3	164
Measure using Multipoint	166
Result	168
Adjust Cardan	170
Cardan Report	172

TWIST

Overview Twist	173
Prepare	174
Measure	176

Result	178
Twist Report	179
BASIC FLATNESS	
Overview Basic Flatness	181
Prepare	182
Measure	184
Result	186
Basic Flatness Report	188
STRAIGHTNESS	
Overview	189
Prepare	190
Connect	191
Measure	194
Result	200
Report	202
BORE CENTER	
Overview	203
Prepare	204
Connect	206
Measure	207
Result	215
Adjust	218
Report	220
BELT	
Overview Belt	223
Prepare	225
Measure with Display unit	228
Measure without Display unit	230
Belt report	232
VIBRATION	
Overview Vibration	233
Configuration	235
Measure with Display unit	238
Vibration Report	239
Measure without Display unit	240
Result	241
Vibration analysis	243
Frequency spectrum	244
Asset management	245
PRECISION LEVEL	
Overview XT290	247
Measure	254

Measure with Display unit	257
---------------------------------	-----

LASER TRANSMITTERS

Laser transmitter XT20/XT22	259
Using the XT20/XT22	263
Calibrate XT20/XT22 electronic levels horizontally	266
Calibrate XT22 electronic level vertically	269
Laser transmitter D22	271
Level D22 horizontally	273
Level D22 vertically	275

TECHNICAL DATA

Display Unit XT12	277
Display unit XT11	279
XT40 Technical data	281
XT50 Technical data	284
XT60 Technical data	288
XT70 Technical data	291
XT20/XT22 Technical data	294
XT21 Technical data	297
XT23 Technical data	299
D22 Technical data	301
XT24 Technical data	303
XT7 Technical data	304
XT9 Technical data	306
XT290 Technical data	308
XT440 Shaft	310
XT550 Shaft	311
XT660 Shaft	316
XT770 Shaft	317
XT980 Sawmill	319
XT190 BTA	321
XT280 VIB	324
Chargers for XT series	326

LEGAL NOTICE

Quality certificate	329
IP code and classification	330
Safety precautions	331
Service and calibration	333
Disposal of old electrical and electronic equipment	333
Copyright	333
Software licenses	334
FCC/IC Warning	337
Privacy Policy and Terms of Use	338

GENERAL INFORMATION

NEW, CONTINUE AND SAVE

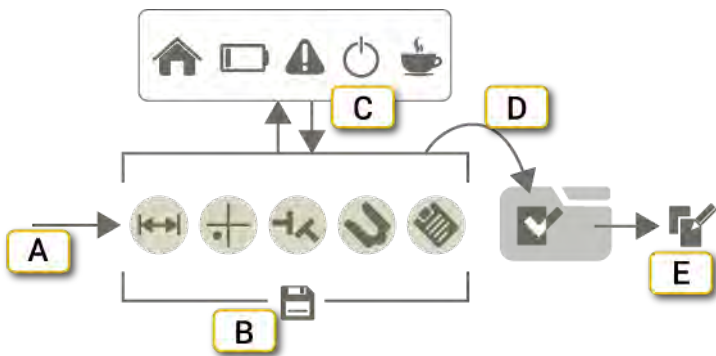

- A. Start a program.
- B. The measurement is saved automatically through the entire workflow.
- C. You can go to the home screen, have a coffee break, charge the batteries or even use another program. Even if you are interrupted, you are able to continue the same measurement session later on.
- D. When you select Finalize, the measurement file is added to the File manager. See "Finalize" on the next page.
- E. It is possible to create a editable copy of the finalized measurement. See "File manager" on page 9.

New or Continue session

Tap the program icon to start a new measurement.

If you leave an ongoing measurement session, the next time you will start the same program you are asked if you want to start a new measurement or continue on the previous session.

●●●	Tap to continue the previous session.
+	Tap to start a new measurement. The ongoing session will be deleted.

Save





The measurement is saved automatically through the entire workflow. When you select Finalize, the measurement file is added to the File manager. See "Finalize" on the next page.

FINALIZE

The measurement is saved automatically through the entire workflow. When you have finished the measurement, you finalize it. When a measurement has been finalized, it is no longer editable. It is however possible to open a copy and continue working were the last session was ended. For information regarding copy and edit: See "File manager" on the facing page.

Finalize a measurement

Usually, you select finalize when you have finished your measurement.

1. Tap  and .
2. Enter a new name, or leave the default name.
3. Tap  if you want to link a code to the measurement. See "QR and barcode" on page 13.
4. Tap . The file is finalized and no longer editable. The measurement file is added to the File manager.

It is possible to create a template of a measurement. See "Templates for measurements" on page 12.

View a finalized measurement

1. Tap  to open the File Manager.
2. Tap the measurement you want to view. The distances are visible but not editable.

If you want to create a editable copy of the open measurement, tap  and  to open a copy of it.

FILTER

If the laser beam passes through air with varying temperature, this may influence the direction of the laser beam. If measurement values fluctuate, this could mean unstable readings. Try to reduce air movements between laser and detector by, for instance, moving heat sources or closing doors. If the readings remain unstable, increase the filter value (more samples will become available to the statistical filter).

Filter is **not** available when you measure with the method Continuous Sweep.

Select filter

Tap  to expand the filter tab. Use as low filter value as possible that still produces acceptable stability during the measurement. Default is set to 0. The filter value you choose, will be default next time you start the program. Select filter on the tab.

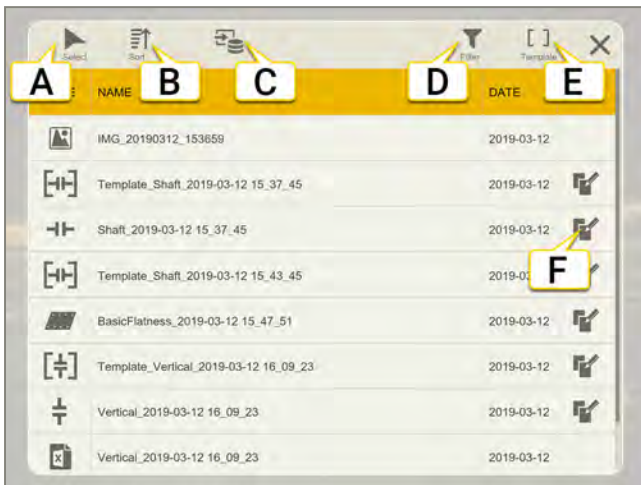

FILE MANAGER

On the Start view, tap  to open the File Manager.





- A. Select files.
- B. Sort files.
- C. Source. Tap to show local files or files on a USB.
- D. Filter view. Use filters to easily find the files you are looking for. See "Filter files" on page 11.
- E. Templates. Quick access to your measurement templates. Tap to open the filter view displaying all your templates.
- F. Create a editable copy of the file. The file will be saved with a new name.

Delete files

1. Tap  to activate check boxes.
2. Select one or many files.
3. Tap . You will be asked to confirm the deletion.

Share files

1. Tap  to activate check boxes.
2. Select one or many files.
3. Tap . On the XT Display Unit it is possible to share to email or USB. Send email to multiple recipients by separating with space, comma or semicolon.



Sort files

By default, the files are sorted by date.

1. Tap .
2. Select Type, Name or Date. It is possible to have rising or falling order.

Copy and edit file





When a measurement has been finalized, it is no longer editable. It is however possible to open a copy and continue working were the last session was ended.

- Tap  to open a editable copy of the selected measurement. This measurement will be saved with a new name when you finalize it.
- If you have a finalized measurement open, tap  and  to open a copy of it.





GENERAL INFORMATION

Import files from USB

By default, the files saved in the Display unit are shown. If you want to import files from a USB, follow these steps:



1. Tap  to select source.
2. Tap  to show the files on the USB memory stick.
3. Tap  to activate check boxes. Select one or many files.
4. Tap  to import the selected files to the Display unit.

File types

	Measurements. All finalized measurements are stored in File Manager and represented by the corresponding program icon. Tap a file to view it. See "Finalize" on page 8.
	Measurement icons with brackets are templates. Tap a file to open it. See "Templates for measurements" on page 12.
	Pdf-report. Tap a file to open it. Reports are stored as pdf-files. See " Report Overview" on page 14.
	Excel file. It is not possible to view Excel files in the XT11 Display unit. To view it, share it to a USB memory stick.
	Photos, IR-photos and screenshots. Images are stored as .png-files. The files are named with the date and time they were created. Tap a file to open it. See "XT Display Unit Camera" on page 32, See "XT Display Unit Screenshot" on page 35.

Filter files

Use filter to easily find the files you are looking for.





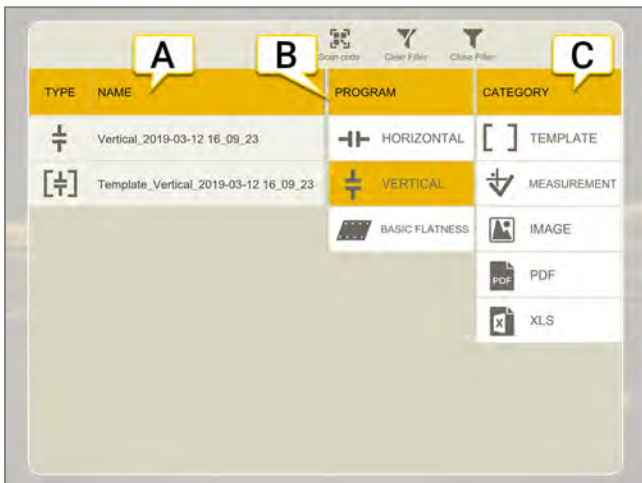



1. Tap  on the start view to open the File Manager.
2. Tap  to open the filter view.
3. Tap a Program and/or Category filter to filter out what you want to see. Tap again to deselect.
4. Select a file from the list to open it.

The filter you have selected will be active until you either close the File manager or tap  to clear the filter.



- A. Filtered file list with type and name. Tap a file to open it.
- B. Program filters. The example above show all files regarding the program Vertical.
- C. Category filters.

Icons

	Clear all filters. Available when you have selected a Program and/or a Category filter.
	Close the filter view.
	Scan a QR code or barcode.
Category icons:	
	Show all templates.
	Show all measurement files.
	Show all images.
	Show all pdf reports.
	Show all excel reports.
	Show all files with a scanned code.





Templates for measurements

Save a measurement as a template to easily reuse the information you enter. A template does not include any measurement data. What kind of information that is saved in the template depends on which program you are using.

Examples of saved information:

- Tolerances
- RPM
- Machine images
- Coupling type
- Locked feet
- Number of feet
- Name of the machines
- Distances
- Thermal compensation
- Report template

Create a template





1. Tap  and .
2. Enter a new name or keep the default name.
3. Tap  if you want to link a code to the measurement. See "QR and barcode" on the facing page.
4. Tap  to create the template. The template is saved in the File manager.

In the File Manager, tap  to quickly access all your measurement templates.





QR and barcode

A code can be linked to measurements and templates. Use our new QR codes, or our older barcodes. Stick a QR (or barcode) on the machine and save the measurement together with the scanned code. Next time, all you need to do is scan the code and all machine data is read.

Save a measurement with QR code

1. Tap  and .
2. Enter a new name, or leave the default name.
3. Tap  to open the scanner. The code is automatically scanned.
4. Tap . The file is finalized and no longer editable. The measurement file is added to the File manager.

Save a template with QR code

1. Tap  and .
2. Enter a new name or keep the default name.
3. Tap  to open the scanner. The code is automatically scanned.
4. Tap  to create the template. The template is added to the File manager.

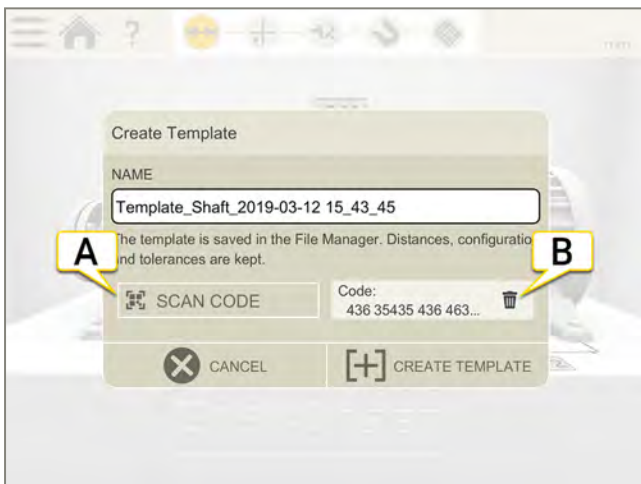

- A. Tap to scan a code.
- B. Tap to delete the code.

Open a file with QR code





- From the Start view: Tap  to open the scanner. If only **one** template is linked to the scanned code, this template is opened directly. If several files are linked to the code, the File manager is opened.
- You can also open scanned files from the filter view in the File manager. See "Filter files" on page 11.

REPORT OVERVIEW

The report covers all details from the measurement. The report is constantly being filled out while the session is carried out. To see the report at its current state, tap  in the workflow.



Save a report

To save a report, you need to **finalize** the measurement. You can choose to save the report as a Pdf or an Excel file. The Excel file is not possible to view in the XT Display unit. To view it, share it to a USB memory stick.



1. Tap  and .
2. Enter a new name, or leave the default name.
3. Go to Report view.
4. Tap  or .

When saving as pdf, it is possible to select a file name. It is also possible to sign the report. The signature is visible in the report.

Select a report template



1. Tap  to open the report.
2. Tap . A sidebar is displayed.
3. Select a template. Which templates that are available depends on which program you are using.

Add a note

1. Tap  and .
2. Write a note and tap OK.



The note is visible in the report.

Add photos

1. Tap  and . The camera is also available from the start view.
2. Tap  to take a photo. Add your photos to the report.



If you have an ongoing measurement and take photos, they can all be added manually in the report view and selected in the File Manager. If you are using a template that does not include photos, the photos you take are only visible in the File Manager.

Add several photos to a report

1. Tap  to open the report.
2. Tap .
3. Select the images you want to add.
4. Tap .



Add user information

The information you enter will be visible in the reports that is using the template "Detailed".

1. Tap  on the startscreen to open the Settings menu.
2. Tap  and enter user information.

See "User information" on page 17

Share a report to USB

1. Tap  in the workflow to open the Report view.
2. Insert a USB memory stick.
3. Tap  to share the file.



You can also share files from the File manager.

SETTINGS

Tap  on the startscreen to open the Settings menu.



Units

You can choose between metric or imperial units for your measurements. The selected unit is shown in the upper right corner of your screen during your measurements.

1. Tap  on the startscreen to open the Settings menu.
2. Tap  and select unit and resolution. Default is set to 0.01 mm.
3. Tap  to close the Settings view. Your new settings are saved.





Language

1. Tap  on the startscreen to open the Settings menu.
2. Tap  and select a language.
3. Tap  to close the Settings view. Your new setting is saved.



User information

The information you enter will be visible in the coming reports. The logo is not visible in the report using the template "Basic".

1. Tap  on the startscreen to open the Settings menu.
2. Tap  and enter user information.

Select logo

1. Insert a USB memory stick to the XT Display Unit.
2. Tap  and select an image. (If you are not using the XT Display Unit, the file manager of your device will be opened.)
3. Tap "Use selected logotype".



Reset logo

Tap  to reset the logotype to standard Easy-Laser. The default logo is 600x124 px.

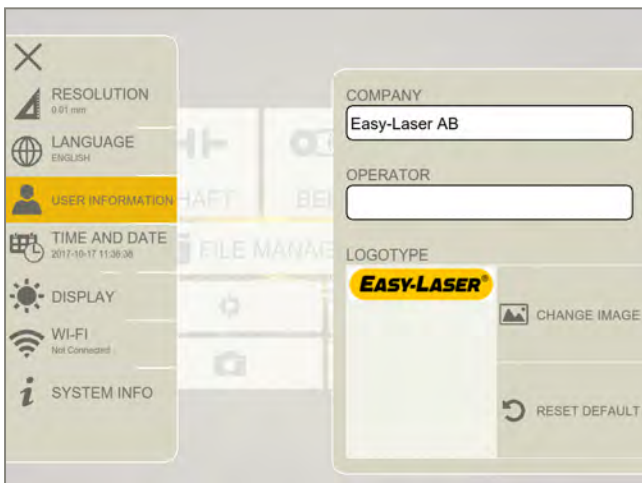
If you reset the logotype, you have to insert the USB memory stick if you want to select your logotype again.



Time and date



1. Tap  on the startscreen to open the Settings menu.
2. Tap  to set the time and date.
3. Set date format and time format.
4. Tap  to close the Settings view. Your new settings are saved.



Device



Adjust the brightness to make it easier to read in bright sunlight for example. Remember however that a high contrast consumes more battery power. Default is set to 40%.

Keyboard sound effects and haptic feedback are active by default. Tick the boxes if you like to turn them off.

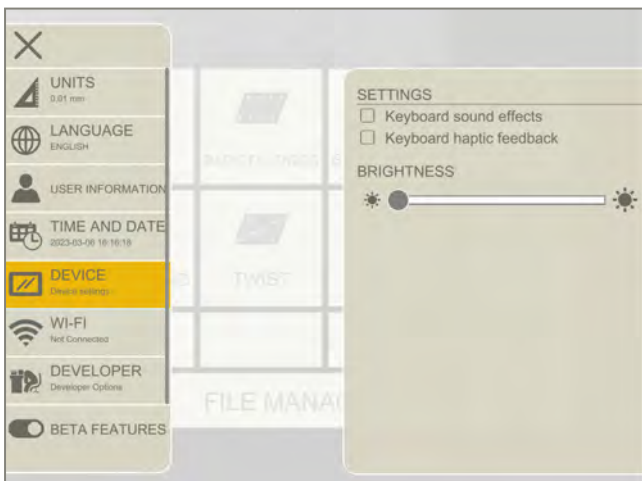
1. Tap  on the startscreen to open the Settings menu.
2. Tap  and adjust the brightness.
3. Tick boxes to turn off Keyboard sound effects or Haptic feedback.
4. Tap  to close the Settings view. Your new settings are saved.







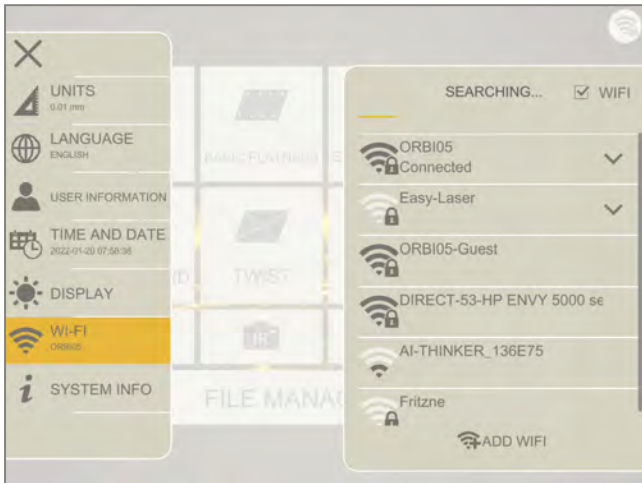

Wi-Fi

1. Tap  on the startscreen to open the Settings menu.
2. Tap  to open Wi-Fi settings.
3. Tap  to close the Settings view. Your new settings are saved.



Icons

	Connected to a Wi-Fi network.
	A locked Wi-Fi. A password is requested.
	Could not connect to Wi-Fi.
	Remove the Wi-Fi network from the list.
	Connected to Wi-Fi, but no Internet connection is detected.
	Tap to display more information regarding the Wi-Fi network and connection.



Select Wi-Fi

Enter the password for the network.

Security options: Open, WEP, WPA/WPA2



System information

1. Tap  on the startscreen to open the Settings menu.
2. Tap  to show system information.



UPDATE: Update Software. See "Update System" on page 22

DETECTOR UPDATE: Update Detector. See "Update System" on page 22



SEND FEEDBACK: If you have any issues or improvement suggestions concerning the XT Measurement System, write and send your feedback to the Easy-Laser app development team. A log file is automatically attached, which is helpful for us in order to test reported issues. By default, the feedback is anonymous, if you want to be contacted, please fill in your contact details.

For Support, see easylaser.com

Data collection

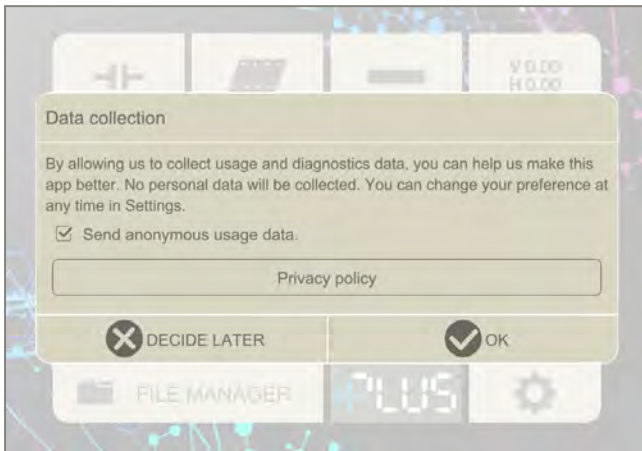
When tapping "OK", you allow Easy-Laser to collect anonymous usage and diagnostics data, for example what measurement programs are being used. This helps us make this app better. No personal data, for example actual measurement data, results or reports, will be collected. You can change your choice at any time in System information, see *below*. For more information See "Privacy Policy and Terms of Use" on page 338



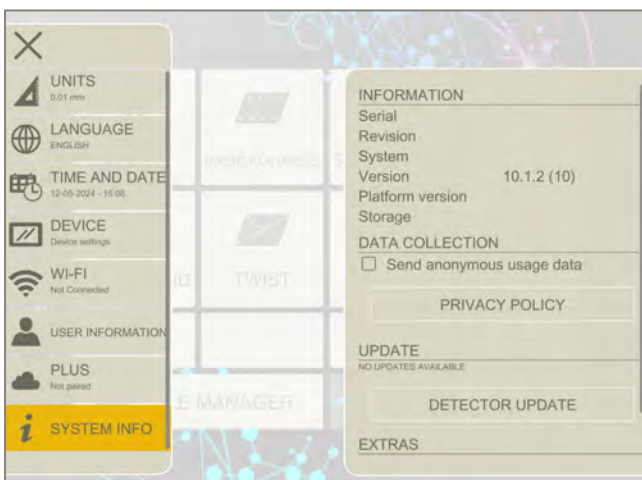

1. Tap  on the startscreen to open the Settings menu.
2. Tap  to show System information.
3. Data collection: Tick box to allow data collection. You can disallow at any time by unticking the box.



UPDATE SYSTEM

Update software



1. Go to our website to check for software updates.
2. Download the updates to a USB (formatted as FAT32).
3. Insert the USB stick.
4. Tap  on the startscreen to open the Settings menu.
5. Tap  to show system information.
6. Tap the file name to install it.



Update detector

If you decide to update your detectors, please update both S- and M-unit.

The file for updating the detectors is downloaded automatically together with the latest software update.

1. Plug your detector and Display unit into power.
2. Tap  on the startscreen to open the Settings menu.
3. Tap  to show system information.
4. Tap "detector update".
5. Select a detector in the list. The Update-button is active if the selected detector is compatible with the update.
6. Tap Update. The update can take up to 15 minutes.
7. Follow the instructions on screen.

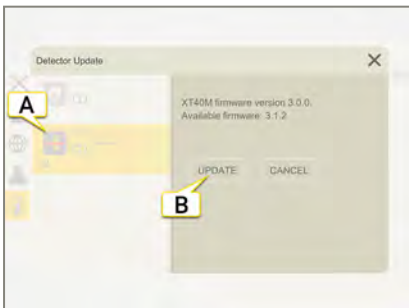

- A. Tap to select a detector
- B. Tap to update the selected detector

EASY-LASER PLUS

Easy-Laser PLUS™ is our cloud solution where you can:

- collect all your measurement files in one place for quick overview and analysis.
- restore deleted files.
- receive the latest news and updates.

Pair your XT app to Easy-Laser PLUS™

1. Tap **PLUS** on the startscreen > select PLUS in the Settings menu.
2. Your code is displayed.

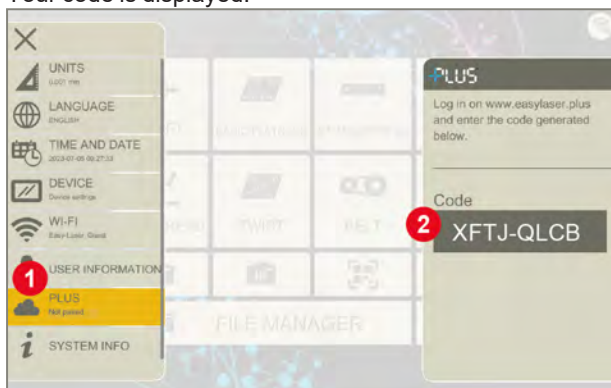

3. Go to <https://easylaser.plus>.
4. Register an Account.
5. Create an Organization (if you are not already member of an organization).

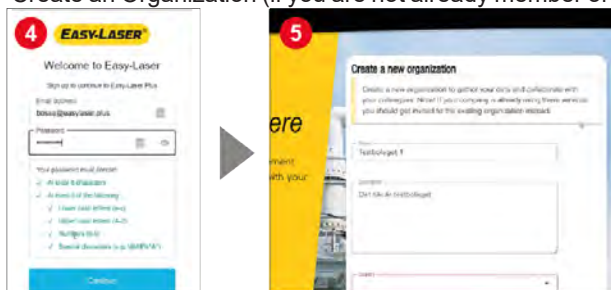

6. Tap "XT apps" > "Pair app".
7. Enter the code displayed in step 2. Enter a name (and optional description) of your app.

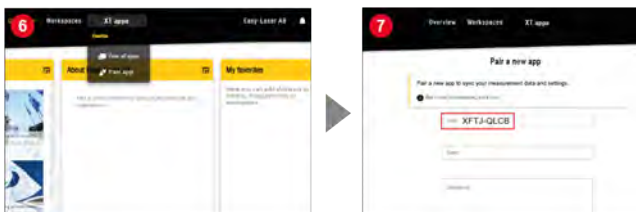

NOTE! To be able to pair an XT app with the Easy-Laser PLUS™, XT app version 9.0 or higher is required.

GENERAL INFORMATION

Upload files to Easy-Laser PLUS™

All files in your XT app are automatically uploaded to Easy-Laser PLUS™ until you unpair your XT app. To unpair, see below.

In Easy-Laser PLUS™ you can preview and share files.

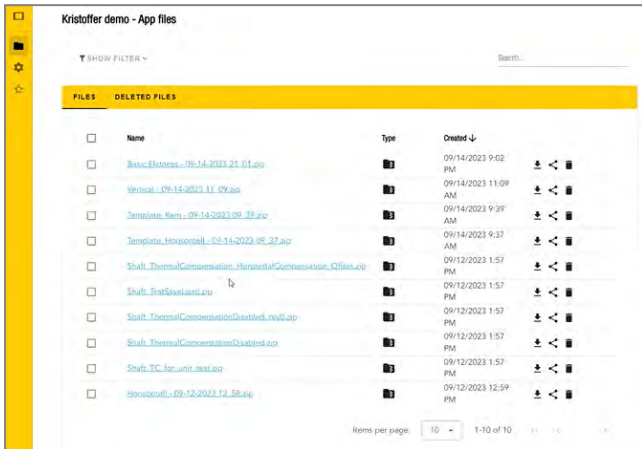



Download files from Easy-Laser PLUS™

If you delete files from your XT app, you can always download them from Easy-Laser PLUS™.

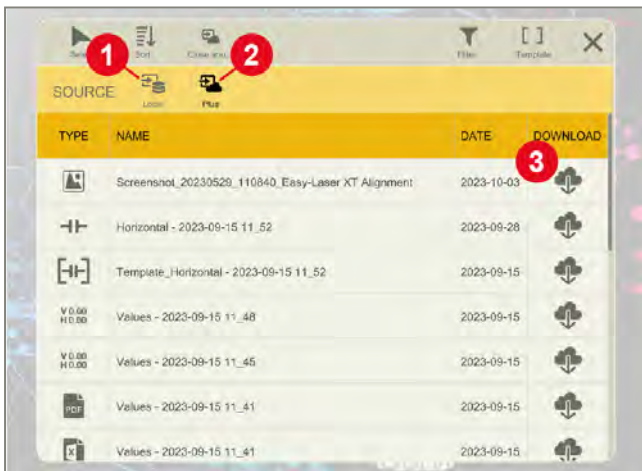
1. Select SOURCE > Local in your XT app File manager to see all your files.
2. Select SOURCE > Plus in your XT app File manager to see all your files uploaded to Easy-Laser PLUS™.
3. Tap  to download a file from Easy-Laser PLUS™.



Unpair your XT app from Easy-Laser PLUS™

1. Tap  on the startscreen > select PLUS in the Settings menu.
2. Tap  to unpair your XT app. To pair it again, just select PLUS in the Settings menu and enter a new code, see "Pair your XT app to Easy-Laser PLUS™" above.



NOTE! Unpairing your XT app means that no more files are uploaded to Easy-Laser PLUS™ whereas all the files that you already have uploaded are saved.

Easy-Laser PLUS connection status

The connection status for Easy-Laser Plus is indicated directly on the Main Menu:

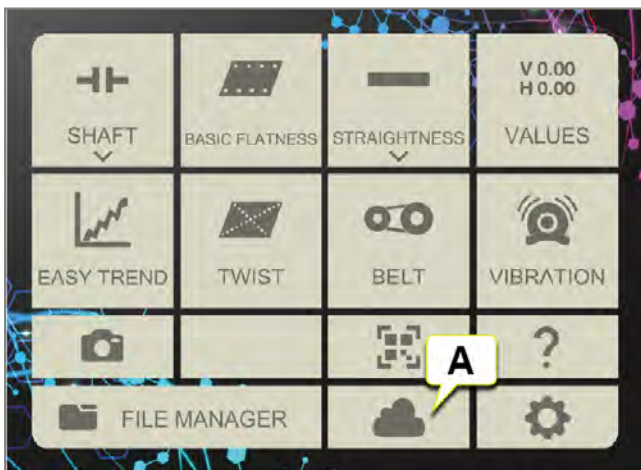

- A. Indicates that Easy-Laser PLUS is connected.  is shown when not connected.

For more extensive information regarding all Easy-Laser PLUS™ features, see www.easylaser.com

CLEANING OF OPTICAL WINDOWS

These cleaning tips are applicable to all Easy-Laser measurement instruments.

NOTE! Clean optical windows only when necessary.

It is recommended that you dust the optics with clean air duster (if available) before wiping.

It is also recommended that you use a suitable optics cleaning solvent (if available) when wiping.

NOTE! Do not use glass cleaning solvents. It may cause streaks.

For wiping, use Easy-Laser Cleaning cloth or other low-lint tissue intended for cleaning optics.

NOTE! Be careful when wiping optics to prevent scratches.

DISPLAY UNITS

XT12 STARTSCREEN

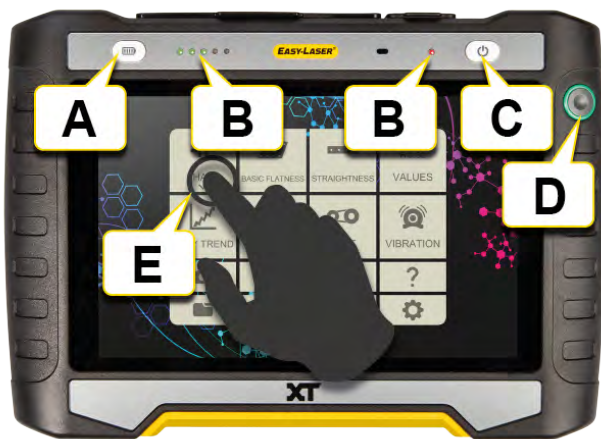

- A. Battery status button. When the Display unit is off: Press to check battery status..
- B. LED indicators for battery status information. See "XT12 Battery Status and charging" on the next page
- C. On/Off button.
- D. OK button.
- E. Tap the screen to open a program.

On the startscreen you will find the icons for the programs you have downloaded, plus some default icons:

	See "File manager" on page 9.
	See "Settings" on page 16.
	Opens the User Manual.
	See "Wi-Fi" on page 19.
	See "XT Display Unit Camera" on page 32
	IR camera, optional equipment.
	See "QR and barcode" on page 13.

For technical information regarding XT12, See "Display Unit XT12" on page 277

XT12 BATTERY STATUS AND CHARGING

The LED indicators [A] and [B] show battery status and charging information for the XT12 display unit.

Charge the display unit by plugging in the power adapter. To fully charge the battery takes approximately 4 hours. It is possible to keep on using the equipment while it is charging.

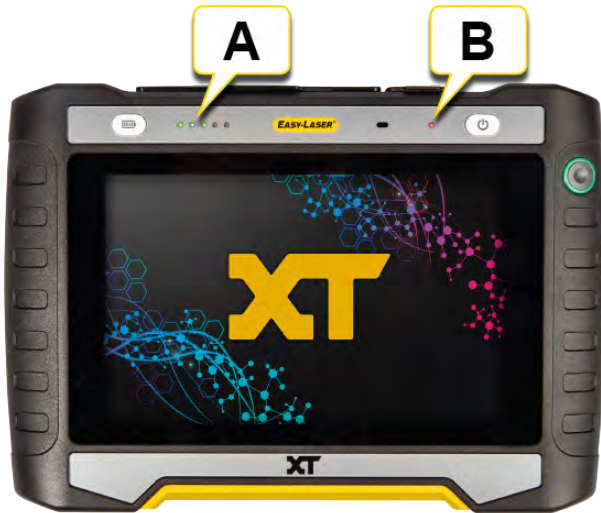

A:	● ● ● ● ●	LEDs are indicating fully charged battery.
A:	● ● ○ ○ ○	LEDs are indicating that the battery needs to be charged.
A:	● > ● > ● > ● > ●	LEDs are flashing when in charging process.
B:	●	LED is indicating that charger is connected.

NOTE! When finished working for the day, charge the XT12 display unit (and the measuring units) by plugging in the power adapter.

Switch battery

If batteries need to be switched, contact your local service center.



Only use batteries provided by Easy-Laser.

XT11 STARTSCREEN



- A. The info display show battery information. See " XT11 Info display" on the next page.
- B. On/Off button.
- C. Lock screen/Battery
When the Display unit is off: Press to see the battery status.
When the Display unit is on: Press to lock the touch function on the screen. Prevents unintentional clicks, for instance when moving between work positions.
- D. OK button.
- E. Tap the screen to open a program.

On the startscreen you will find the icons for the programs you have downloaded, plus some default icons:

	See "File manager" on page 9.
	See "Settings" on page 16.
	Opens the User Manual.
	See "Wi-Fi" on page 19.
	See "XT Display Unit Camera" on page 32
	IR camera, optional equipment.
	See "QR and barcode" on page 13.

For technical information regarding XT11, See "Display unit XT11" on page 279.

NOTE! As of November 2022, the XT alignment app no longer supports the XT11 rev 1 Display unit (serial number 129231 or lower). XT alignment app version 8.1 and higher will not be compatible with XT11 rev 1.











NOTE! XT measuring units produced in November 2022 or later will not be compatible with the XT11 rev 1 Display unit (serial number 129231 or lower). If you want to purchase new measuring units and are currently using an XT11 rev 1 Display unit, please contact your local distributor for advice before placing an order.

XT11 INFO DISPLAY



The info display gives information about the battery status for both the Display unit and the connected measuring units. When the Display unit is off, you can press  to show battery information.



- A. Battery information for the connected measuring units.
- B. Serial number for the measuring unit. This number is also found on the back of the measuring unit.
- C. The screen is locked. Press  to enable the touch function on the screen again.
- D. Battery information for Display unit XT11. (XT11 includes two separate battery packs)

	The remaining battery power is shown in percentage.
	Battery is low, less than 10%. Please charge.
	The battery is being charged. When fully charged it shows 100.
	No batteries, the Display unit is run via the adapter.
	The battery is hot. The charging capacity is limited.
	The battery is cold. The charging capacity is limited.
	The battery is empty, the Display unit will turn off shortly.
	System fail, try to restart the Display unit.
	Unbalanced battery. Remove the adapter, start the Display unit and wait. When the warning is gone, charge the Display unit.
	The battery cover is open. Close the cover.
	Inconsistent charging, this overrides all other warnings. One of the battery packs may be malfunctioning. Reconnect adapter. If the warning is persistent, contact Service center.

Lock screen

When the Display unit is on: Press  lock the touch function on the screen. Prevents unintentional clicks, for instance when moving between work positions. To unlock, press  again.

XT11 CHARGING

Charge the display unit by plugging in the power adapter. For information about the battery status See " XT11 Info display" on the previous page. To fully charge the battery takes approximately 3 hours. It is possible to keep on using the equipment while it is charging.



NOTE! When finished working for the day, charge the XT11 display unit (and the measuring units) by plugging in the power adapter..

Switch battery

It is recommended that you contact your local service center if batteries have to be switched.

XT DISPLAY UNIT CAMERA

The camera is default in the XT Display Unit. It is possible to buy an XT Display Unit without a camera. It cannot be retrofitted.





1. Tap  and . The camera is also available from the start view.
2. Tap  to take a photo.

The photo is saved in File manager as a .png file. It is named with current date and time. If you have an ongoing measurement (and using a layout that will include a photo), the **latest** photo is added to the report automatically. If a new photo is taken, the previous one will be overwritten.

It is also possible to add several photos to a report. See " Report Overview" on page 14.

XT DISPLAY UNIT IR CAMERA

The IR (thermal) camera is optional equipment (Part No. 12-0968) and cannot be retrofitted.

1. Tap  and . The camera is also available from the start view.
2. Tap  to start the IR camera. Allow the camera to acclimatise for about five minutes in the environment in which it is to be used. This will ensure an optimal IR measurement.
3. Press  to take a photo.

An IR photo is saved in the File manager as a .png file. It is named with current date and time. If you have an ongoing measurement, the photo is added to the report.

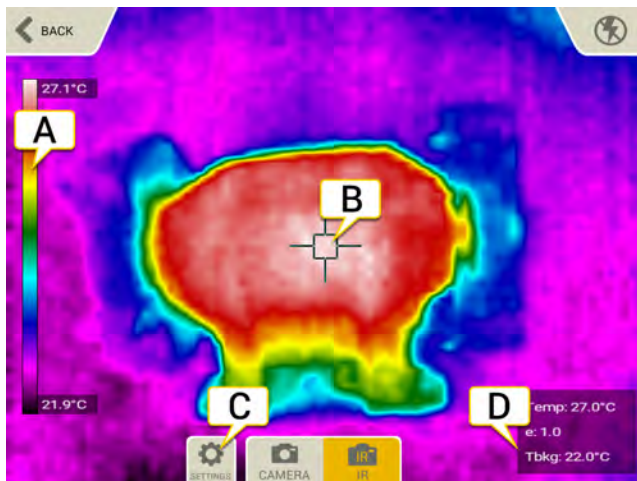

- A. Heat scale (when selected in Settings).
- B. Crosshair (when selected in Settings). This is where the temperature is registered (Temp, e and Tbkg).
- C. Tap  to open Settings.
- D. Temp: The average temperature (in crosshair).
e: The emissivity value.
Tbkg: The reflected background temperature.

IR Camera Settings

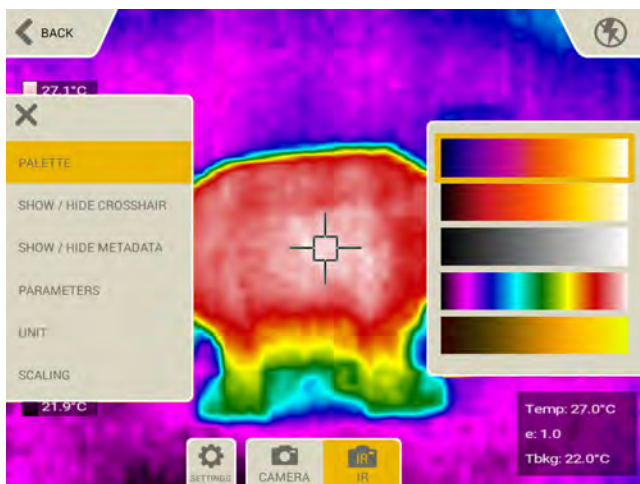

Palette

Change the color presentation of the infrared images. Select between iron, glowbow, grey, rain or yellow.

Show/hide

If you hide the crosshair and/or metadata, it will not be shown on the saved image either.

Emissivity (e)

The emissivity value of the surface/object is captured by the crosshair. The correct emissivity value is important for an accurate calculation. Possible values: 0.01 - 1.00, but we do not recommend value below 0.6. The value is normally set from a list of emissivity values for some common materials.

- 1.00 for a perfect blackbody.
- 0.01 for a perfect shiny (in the infrared spectrum) object.

Background temperature (Tbkg).

The reflected background temperature of the surface/object. Can normally be set to the ambient temperature. Value <382°C (720°F). Has no effect when $e = 1.00$

Unit

Select Celsius or Fahrenheit.

Scaling



By default, manual scaling is **not** used and the heat scale of the image will adjust automatically from the lowest temperature to the highest temperature of the IR image.

If you select manual scaling, you can decide which temperatures you want to visualize.

- Scale max: Enter a temperature (up to 450°C).
- Scale min: Enter a temperature (down to 0°C).

XT DISPLAY UNIT SCREENSHOT

It is possible to take screenshots of what is currently displayed on the XT Display Unit screen.

1. Press the  button.
2. Tap .
3. The screen dump is saved in File manager as a .png file. It is named with current date and time.

MEASURING UNITS

SELECT MEASURING UNITS

If you have used any measuring units before, these will automatically be connected. There are also demo detectors available.

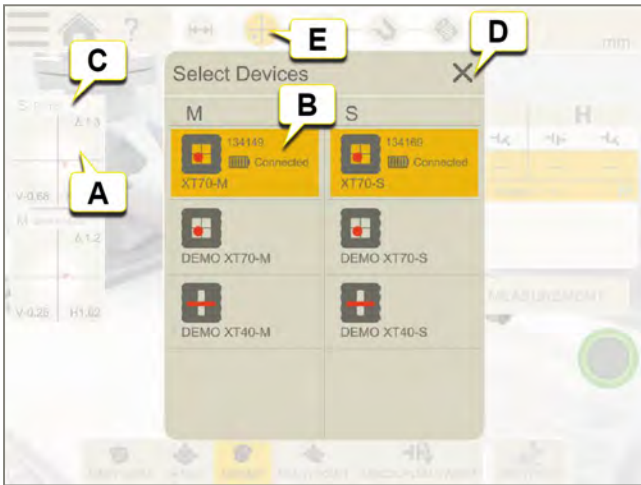

- A. Tap a target to display the device list.
- B. Select the devices you wish to connect. Tap selected device to disconnect.
- C. Device type and serial number.
- D. Tap **X** to close.
- E. Tap Measure icon in the workflow to start measuring.

For selecting Measuring units in Values and Straightness, see respective chapter.

Measuring units and programs

	XT70	XT60	XT50	XT40
Values	X	X	X	X
EasyTrend	X			
Horizontal (EasyTurn or 9-12-3)	X	X	X	X
Horizontal (Multi or Sweep)	X	X	X	
Horizontal (Adjustment Guide)	X		X	
Machine Train (two couplings)	X	X	X	
Machine Train (two or more couplings)	X		X	
Machine Train (Adjustment Guide)	X		X	
Vertical	X	X	X	X

MEASURING UNITS

Cardan	X	X	X	
Twist	X	X	X	
Basic Flatness	X			
Straightness	X			

The live option "Live360" is only available when using **XT70**.

Charge

Charge the measuring units by plugging in the power adapter intended for the measuring units.



To fully charge the battery takes approx. 2 hours. Operating time for XT40 and XT60 is up to 24 h.

It is possible to keep on using the equipment while it is charging.

NOTE! When finished working for the day, charge the whole system. Plug in the power adapter to the measuring units.

Information in the Display unit

Information regarding the Measuring units is also shown in the Display unit. On the targets you can clearly see when the battery is running low and the inclinometer value for example.

	Battery information.
	No measuring unit is connected. Tap the target to find possible units.
	Inclinometer value.

Edge warning

When the laser beam is close to the edge, the edge is "lit up" as a warning. It is still possible to register values when the edge warning is active.

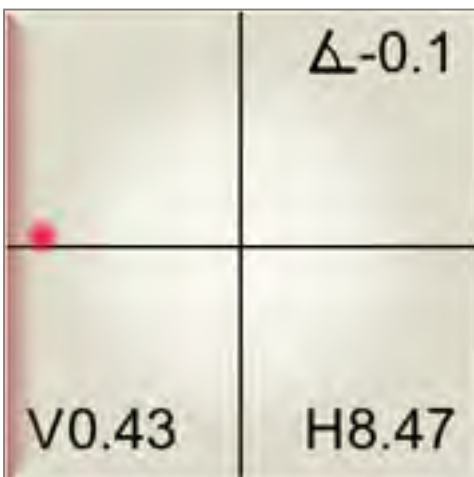

Troubleshooting

- Make sure that the measuring units are turned on.
- Make sure that they are charged.

- Make sure that you have NOT paired your measuring units outside of the XT app before starting the app. Doing so will cause the measuring units to not show up in the app.
- Make sure that "Location services" is on. On a phone or tablet, this function is usually found under Settings > Integrity/Location.

NOTE! If you don't want to say "yes" to geographic location services for any reason, we recommend that you use the Easy-Laser XT Display Unit. The XT-app never records or saves any location data, regardless if it is on a XT Display Unit or a mobile telephone.

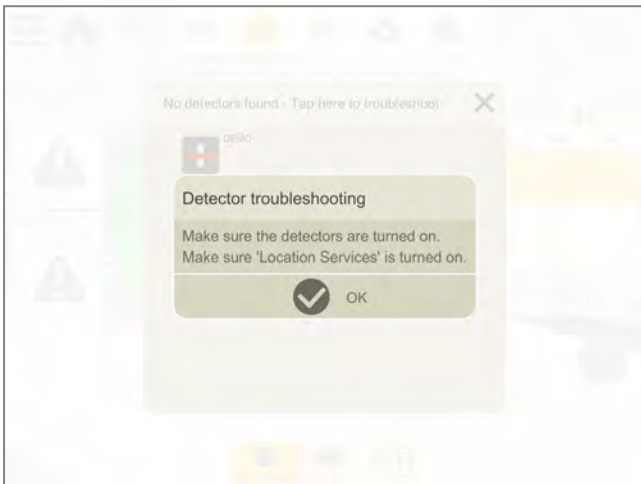

NOTE! XT measuring units produced in November 2022 or later will not be compatible with the XT11 rev 1 Display unit (serial number 129231 or lower). The new measuring units have the UKCA mark on the label from November 2022 onwards. If you want to purchase new measuring units and are currently using an XT11 rev 1 Display unit, please contact your local distributor for advice before placing an order.

XT40

The XT40 measuring units utilize line-type laser and 30 mm PSD.

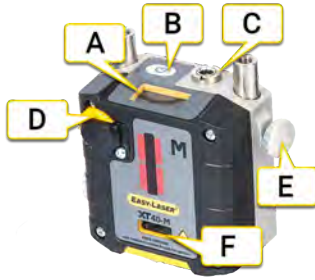

- A. Info display
- B. On/Off button
- C. Connection for charging cable
- D. Laser adjustment knob
- E. Locking knob
- F. Laser aperture

Info display

The measuring unit is equipped with an info display showing the angle value and battery information. The info display becomes active when the measuring unit is started.

	During start up, the display shows either the version or the type of the measuring unit. The start up screen is dependent on the version of the measuring unit and might change after a firmware upgrade.
	Start up takes approximately 3 seconds.
	The battery icon shows, in percentage, how much battery power that remains.
	The battery is being charged. When fully charged the symbol shows 100.
	Less than 10 % of the battery capacity remains. Charge the unit.
	The unit is unable to give information about the battery. Charge the unit until the battery icon shows 100.
	Something is wrong with the battery. It may be missing or damaged.
	The unit is shutting down. Shutting down takes approximately 3 seconds.
	Malfunction. Restart the unit, if it does not help, please contact your service center.
	System failure. Note the error code and contact your service center. Turn off the unit, do not charge.
	This icon indicates that wireless communication is established between the Display unit and measuring unit.

Set up XT40

1. Mount the S-unit on the stationary machine and the M-unit on the movable machine. You can place the measuring units up to 10 m apart.
2. Mount the units facing each other. Make sure they are at the approximately same rotational angle and radius. You need to place the measuring units with an offset. See image.

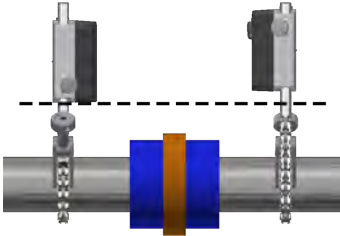

Place the measuring units with an offset

Rough align XT40

When making a new installation, a rough alignment can be necessary. Place the Measuring units on the rods, make sure they are at the approximately same rotational angle and radius. Also make sure that the adjustment knob is adjustable in both directions.

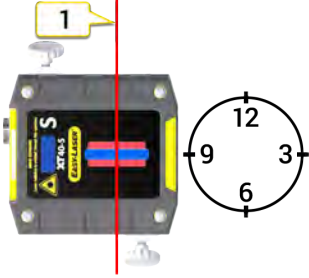
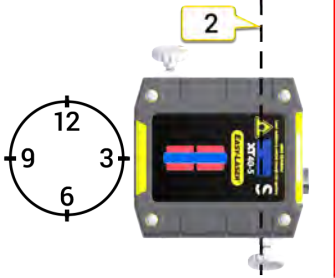
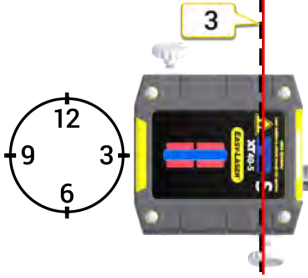
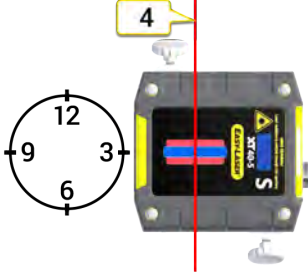
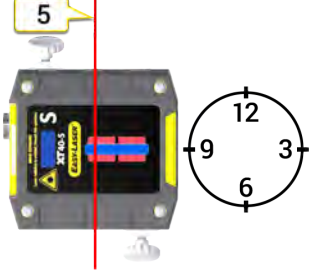
	<p>1. Place the Measuring units at 9 o'clock. Adjust the laser line to the center of both targets. Use the adjustment knob and/or move the detectors on the rods.</p>
	<p>2. Turn the shafts 180°. Make a mark on the rods or machine halfway between the laser line and center of both targets.</p>
	<p>3. Adjust the laser beams half way to the center of targets. Use the adjustment knobs and/or move the detectors on the rods.</p>
	<p>4. Adjust the movable machine until the laser beam hits the center of both targets.</p>
	<p>5. Turn the shafts 180°. Check if both laser lines hit the targets. If not, repeat step 3–5. Turn shafts to 12 o'clock. Repeat all steps for vertical adjustment.</p>

XT50

The XT50 measuring units are ATEX approved for use potentially explosive environments. The units utilize dot-type laser and 1-axis square PSD surfaces.

XT50 is an intrinsically safe laser product, please read the safety instructions. See "XT550 Shaft" on page 311.

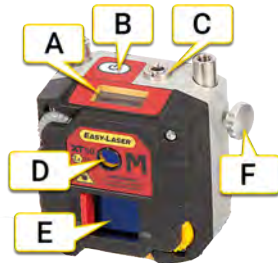

- A. Info display
- B. On/Off button
- C. Connection for charging cable
- D. Laser aperture
- E. PSD aperture

Info display

The measuring unit is equipped with an info display showing the angle value and battery information. The info display becomes active when the measuring unit is started.

	During start up, the display shows either the version or the type of the measuring unit. The start up screen is dependent on the version of the measuring unit and might change after a firmware upgrade.
	Start up takes approximately 3 seconds.
	The battery icon shows, in percentage, how much battery power that remains.
	The battery is being charged. When fully charged the symbol shows 100.
	Less than 10 % of the battery capacity remains. Charge the unit.
	The unit is unable to give information about the battery. Charge the unit until the battery icon shows 100.
	Something is wrong with the battery. It may be missing or damaged.
	The unit is shutting down. Shutting down takes approximately 3 seconds.
	Malfunction. Restart the unit, if it does not help, please contact your service center.
	System failure. Note the error code and contact your service center. Turn off the unit, do not charge.

MEASURING UNITS



This icon indicates that wireless communication is established between the Display unit and measuring unit.

Set up XT50

1. Mount the S-unit on the stationary machine and the M-unit on the movable machine. You can place the measuring units up to 20 m apart.
2. Mount the units facing each other. Make sure they are at the approximately same rotational angle and radius.

Rough align

When making a new installation, a rough alignment can be necessary. Place the measuring units on the rods, make sure they are at the approximately same rotational angle and radius. Also make sure that the adjustment knob is adjustable in both directions. The example below shows the M-unit, but the procedure is made on both units.

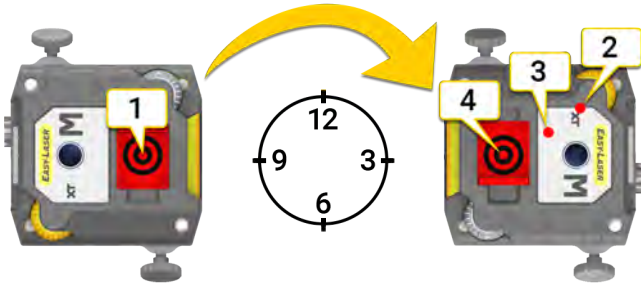

1. Place the units at 9 o'clock. Aim the laser beams at the center of the targets.
2. Turn the shaft to position 3 o'clock. Note where the laser beams hit.
3. Adjust the laser beams half way to the center of targets. Use the adjustment knobs.
4. Adjust the movable machine until the laser beam hits the center of targets.

XT60

The XT60 measuring units utilize dot-type laser and 1-axis square PSD surfaces.



- A. On/Off button
- B. Connection for charging cable
- C. Info display
- D. Laser adjustment knob
- E. Laser aperture
- F. PSD aperture
- G. Locking knob

Info display

The measuring unit is equipped with an info display showing the angle value and battery information. The info display becomes active when the measuring unit is started.

	During start up, the display shows either the version or the type of the measuring unit. The start up screen is dependent on the version of the measuring unit and might change after a firmware upgrade.
	Start up takes approximately 3 seconds.
	The battery icon shows, in percentage, how much battery power that remains.
	The battery is being charged. When fully charged the symbol shows 100.
	Less than 10 % of the battery capacity remains. Charge the unit.
	The unit is unable to give information about the battery. Charge the unit until the battery icon shows 100.
	Something is wrong with the battery. It may be missing or damaged.
	The unit is shutting down. Shutting down takes approximately 3 seconds.
	Malfunction. Restart the unit, if it does not help, please contact your service center.
	System failure. Note the error code and contact your service center. Turn off the unit, do not charge.
	This icon indicates that wireless communication is established between the Display unit and measuring unit.

Set up XT60

1. Mount the S-unit on the stationary machine and the M-unit on the movable machine. You can place the measuring units up to 20 m apart.
2. Mount the units facing each other. Make sure they are at the approximately same rotational angle and radius.

Rough align

When making a new installation, a rough alignment can be necessary. Place the measuring units on the rods, make sure they are at the approximately same rotational angle and radius. Also make sure that the adjustment knob is adjustable in both directions. The example below shows the M-unit, but the procedure is made on both units.

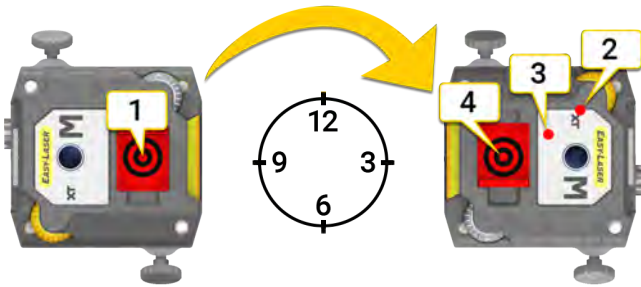

1. Place the units at 9 o'clock. Aim the laser beams at the center of the targets.
2. Turn the shaft to position 3 o'clock. Note where the laser beams hit.
3. Adjust the laser beams half way to the center of targets. Use the adjustment knobs.
4. Adjust the movable machine until the laser beam hits the center of targets.

XT70

The XT70 measuring units utilize dot-type laser and 2-axis square PSD surfaces.



- A. On/Off button
- B. Connection for charging cable
- C. Info display
- D. Laser adjustment knob
- E. Laser aperture
- F. PSD aperture
- G. Locking knob

Info display

The measuring unit is equipped with an info display showing the angle value and battery information. The info display becomes active when the measuring unit is started.

	During start up, the display shows either the version or the type of the measuring unit. The start up screen is dependent on the version of the measuring unit and might change after a firmware upgrade.
	Start up takes approximately 3 seconds.
	The battery icon shows, in percentage, how much battery power that remains.
	The battery is being charged. When fully charged the symbol shows 100.
	Less than 10 % of the battery capacity remains. Charge the unit.
	The unit is unable to give information about the battery. Charge the unit until the battery icon shows 100.
	Something is wrong with the battery. It may be missing or damaged.
	The unit is shutting down. Shutting down takes approximately 3 seconds.
	Malfunction. Restart the unit, if it does not help, please contact your service center.
	System failure. Note the error code and contact your service center. Turn off the unit, do not charge.
	This icon indicates that wireless communication is established between the Display unit and measuring unit.

Set up XT70

1. Mount the S-unit on the stationary machine and the M-unit on the movable machine. You can place the measuring units up to 20 m apart.
2. Mount the units facing each other. Make sure they are at the approximately same rotational angle and radius.

Rough align

When making a new installation, a rough alignment can be necessary. Place the measuring units on the rods, make sure they are at the approximately same rotational angle and radius. Also make sure that the adjustment knob is adjustable in both directions. The example below shows the M-unit, but the procedure is made on both units.

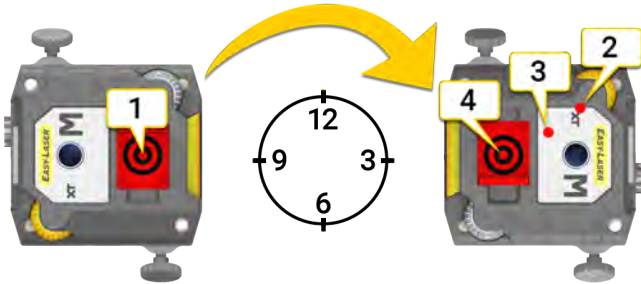

1. Place the units at 9 o'clock. Aim the laser beams at the center of the targets.
2. Turn the shaft to position 3 o'clock. Note where the laser beams hit.
3. Adjust the laser beams half way to the center of targets. Use the adjustment knobs.
4. Adjust the movable machine until the laser beam hits the center of targets.

VALUES

OVERVIEW

In this program you can measure any application where no other measurement program is applicable, for example bearing play check or rotating shaft quick test without having to specify any machine parameters.

The Values program gives you plain values and the possibility to register a larger number of measuring points than in the application programs. You will see live readings from the measuring units. The program can also handle dynamic measurements which means you can record values over a period of time with a set frequency.

You are free to choose any Easy-Laser geometric laser transmitter (except spin laser) to point the laser beam on your M measuring unit. The S measuring unit only accepts an M measuring unit as laser source. A line laser unit can only be combined with another line laser unit.

On the start view, tap $\begin{matrix} V 0.00 \\ H 0.00 \end{matrix}$ to open the program.

Measuring unit detectors to be used: XT40-M, XT50-M, XT60-M, XT70-M and XT9. (Please note that the line laser units XT40-M and -S can only work with each other.) Use the M unit as detector and the S unit as transmitter. If a separate laser is used, the M unit should be used as the detector.

Laser transmitters to be used: XT20/XT22, D22, D25, D26, D75, E30 and all the shaft alignment units.

Other units: You can also use the Values program to register values from the Digital Precision Level XT290.

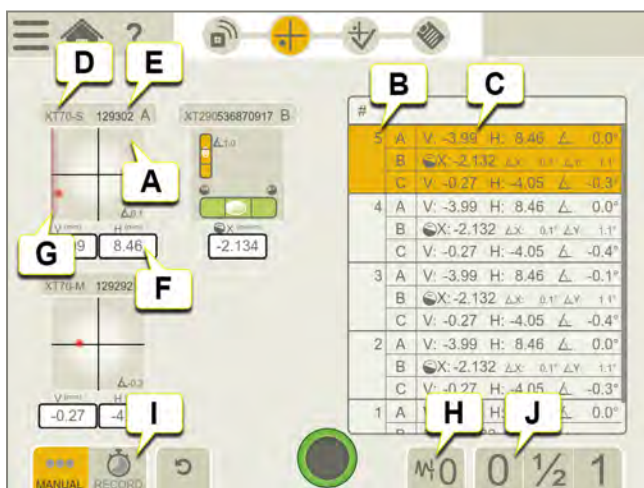

- A. Live Device View. (1-4 devices can be connected). See "Connect" on page 53
- B. Measurement instance.
- C. Registered values.
- D. Device type.
- E. Serial number.
- F. Live reading of detector.

VALUES

- G. Edge warning. When the laser beam is close to the edge, the edge is "lit up" as a warning. It is still possible to register values when the edge warning is active, but the measurement accuracy may be reduced.
- H. Filter. See "Filter" on page 8
- I. Autorecord. See "Autorecord" on page 60
- J. Zero set or halve value. See "Measure" on page 55

Context menu

Tap the Live Device View to open Context menu. In the Context menu you can enlarge the device information, halve or zero set values for the selected detector live reading. Here you can also set angular units and resolution for Precision level XT290 and Laser transmitter XT20/XT22. See "Measure" on page 55
In the Context menu you can also calibrate laser XT20/XT22 electronic levels.

NOTE! Halving value is not applicable to Precision Level XT290.

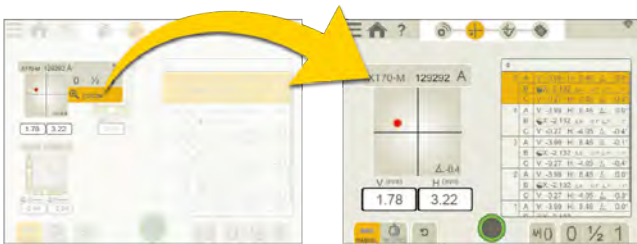

Calibration of XT20/XT22

NOTE! If you want to use electronic levels, these must be calibrated before you start measuring.

See "Calibrate XT20/XT22 electronic levels horizontally" on page 266

See "Calibrate XT22 electronic level vertically" on page 269

CONNECT

Select the measuring devices you wish to connect. It is possible to connect up to 4 devices. Type of measuring unit and serial number are displayed in the Device list below.

NOTE!

Once you have registered a measurement value you can not return and change your device setup.



- A. Select the devices you wish to connect.
- B. Tap + to increase number of devices.
- C. Tap - to decrease number of devices.
- D. Tap to connect possible reference detector, for more information See "Measure" on page 55
- E. Tap Measure icon in the workflow to start measuring.

Read up to four devices simultaneously

In the "Values" program you can read up to four devices simultaneously.

For example: A dynamic measuring with two measurement units and two XT290 to sort out the actual change of the position of a machine component under load in combination with change of position according to level of base.

NOTE! XT70-M and XT9 measuring units can be used as reference detector. An XT70-S measuring unit can also be used as reference detector. How to set the XT70-S to reference mode, See "Measure" on page 55

Setting of angular unit for Precision Level XT290 and XT20/XT22

Set angular unit and resolution (number of decimals) for XT290 and XT20/XT22 by using the Values Settings menu. The angular unit and resolution in the XT290 and the XT20/XT22 display will be the same as the settings in the Values Settings menu.

NOTE! When XT290 is connected to the XT app, the settings for "Unit", "Resolution" and "Filter" can only be made in the XT app. When connected to the XT app, these display menus are disabled in XT290 and "Factory reset" is completely disabled.

NOTE! When settings are changed in the XT app during connection, the app settings apply to the XT290 and XT20/XT22. When disconnected, the XT290 and XT20/XT22 settings return to the settings made before the connection.

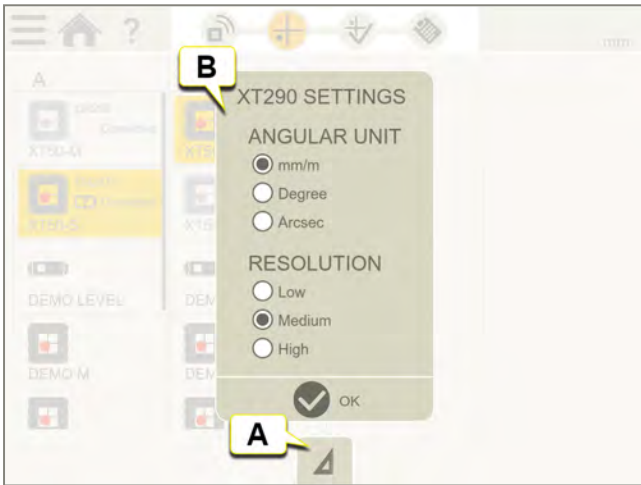

- A. Tap Settings tab.
- B. Set Angular unit and Resolution (number of decimals).

MEASURE

Tap  to register values.

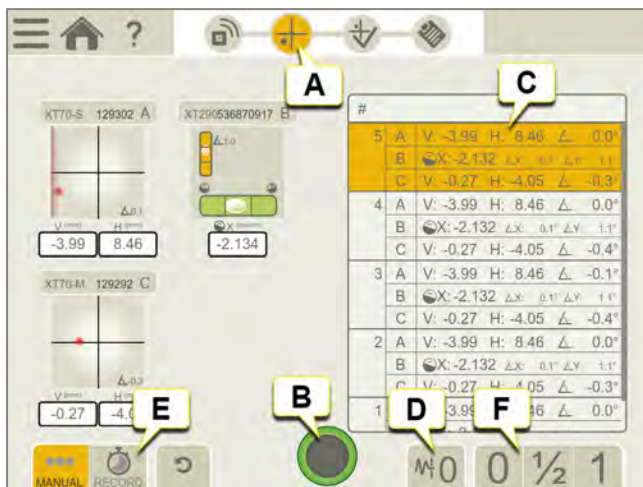

- Measure icon is active in the workflow.
- Tap to register measurement values.
- Registered measurement values.
- Filter. See "Filter" on page 8
- Autorecord. See "Autorecord" on page 60
- Halve or zero set value.

Enlarge a specific live reading

This is useful when you need to read from a distance. Here you can also set angular units and resolution for Precision level XT290 and Laser transmitter XT20/XT22



- Tap the Live Device View to open Context menu.
- Tap "Zoom" to enlarge selected live reading.

Halve value

- Tap the Live Device View to open Context menu.
- Tap $\frac{1}{2}$ on the tab to halve the displayed value. Zero point of the target moves halfway towards the laser point.
- Tap **1** on the tab to return to the absolute value. Zero point of the target returns to the center.

VALUES

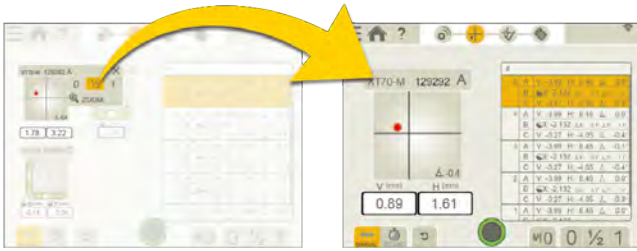

NOTE! Halving value is not applicable to Precision Level XT290. Halving or zero setting value is not applicable to Laser transmitter XT20/XT22.

Zero set value

1. Tap the Live Device View to open Context menu.
2. Tap **0** on the tab to zero set the displayed value. Zero point of the target moves to the laser point. For XT290 the bubbles will be centered.
3. Tap **1** on the tab to return to the absolute value. Zero point of the target returns to the center. For XT290 the bubbles will return to their original positions.



Measure with reference detector

When measuring, you can check the value from the reference detector by pressing the Device button. It is only possible to monitor the values from the reference sensor.

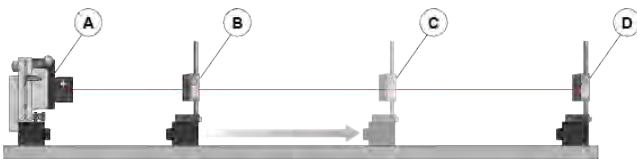

- A. Laser transmitter.
- B. M unit detector.
- C. M unit detector at farthest point to be measured.
- D. S unit used as reference detector during Measuring-procedure, placed beyond farthest point to be measured. Zero set and halve value when live device is zoomed in (remove M unit detector [C] when checking the reference detector).

An XT70-S can be used as reference detector. To set it to Reference mode, see below. When set to Reference mode the XT70-S display will show an "R". Other detectors that can be used as reference detectors are XT70-M and XT9. These detectors will not show an "R" when set to reference mode.



Display showing an "R" when XT70-S is set to Reference mode.



- A. Tap to display Reference detector Live Device.
- B. Tap to set XT70-S to "Reference mode".
- C. Zero set and halve the value when Live Device is displayed.
This does not affect the measurement.

NOTE! The XT70-S unit will behave as an M unit when "Reference mode" is selected in the app, meaning M values are shown in the display. This is indicated by an "R". The XT70-S unit is automatically set to "Reference mode" during the entire measurement session. The XT70-S will go back to "normal mode" when disconnected from the app.



NOTE! "Reference mode" will automatically be switched off when you change program, for example to "Shaft".

VALUES

Warnings during measurement



The following Warnings may appear in the "Values" device information.



- A. Shake warning for XT290 and XT20XT22. Disappears when shaking stops.
If vibrations are strong enough to make the shake warning appear during measurement, increase the filter level from XT app. See "Overview XT290" on page 247
See "Using the XT20/XT22" on page 263
- B. Temperature warning for XT290. Press  on XT290 to clear. Press  again for temperature information in the menu.
Temperature warning for laser transmitter. Deactivate by selecting Temperature warning "OFF" in the XT app.
- C. Device disconnected.
- D. Low battery warning. Charge the measuring device.

AUTORECORD

In Values, it is possible to make automatic recording of values. This is very useful when you want to register values during a longer time period for example.

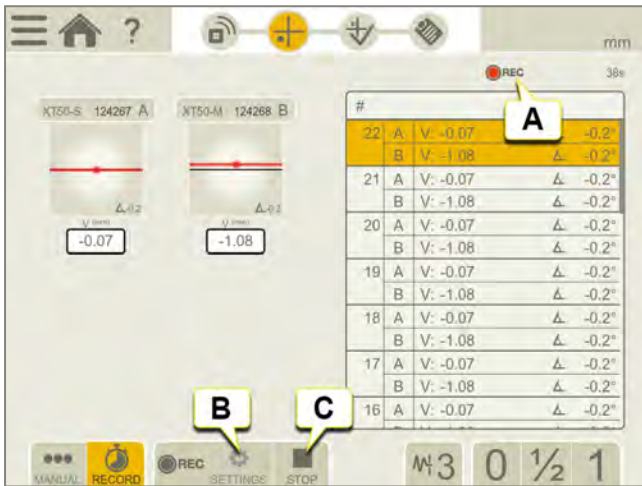

1. Tap  to open the Autorecord tab.
2. Tap  to start recording values.
3. The recording will start and you can follow the progress on screen.
4. Tap  to stop the measurement.

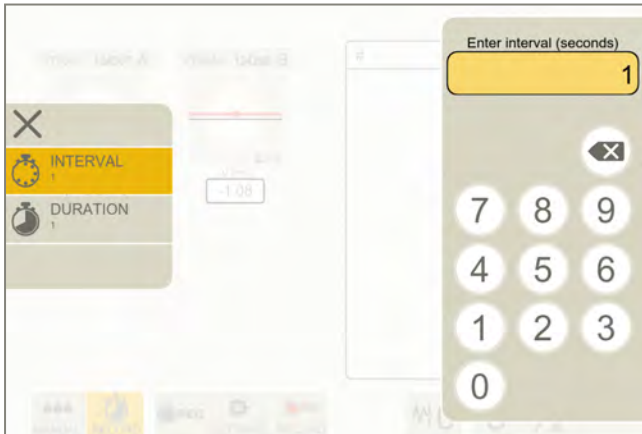

- A. Indicates that values are being recorded.
- B. Tap to set duration and interval.
- C. Stop the measurement.



Duration and interval

1. Tap  to open Settings.
2. Tap  to set the interval. Default is set to one second.
3. Tap  to set the duration. Default is set to one minute.



Limitations of Values automatic recording

Factors that may affect maximum number of measurement values and recording time:

- How much disc space is available on your unit. This depends on how many files and pictures you have saved on your Display Unit, how many apps you have installed, if you are using a phone or a tablet.
- How much memory (RAM) is available on your unit. This depends on the device you are using and the number of programs you are running at the same time.

RESULT

Tap  to display the Result view. A table or a graph shows the result. You can try different settings and analyze the summary of the measurement result directly in the Display unit before you move on to "Report"

Tap  and  to finalize the measurement. The measurement is saved in the File manager.

NOTE! As long as you haven't finalized the result you can return to "Measure" and continue to register values.

View the result as a table



- A. Measurement results.
- B. A note has been added.
- C. Delete measurement instance (not applicable if you have finalized the measurement in "Measure").
- D. Delete all values (not applicable if you have finalized the measurement in "Measure").

View the result as graphs

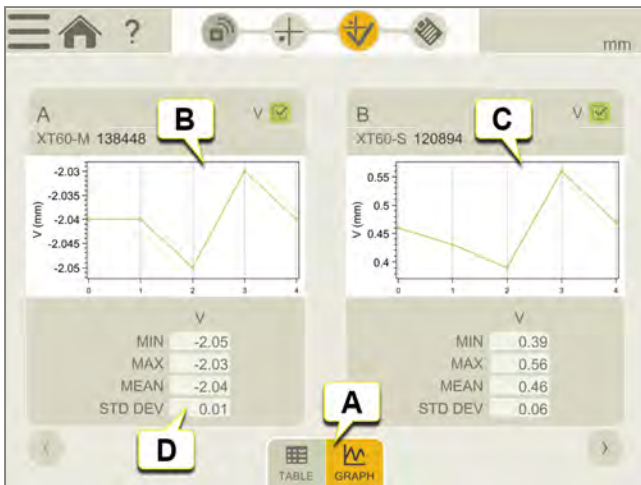



- Toggle between table and graph view.
- Graph showing a visual representation of the measurement data for the chosen measuring unit.
- Graph showing a visual representation of the measurement data for the chosen measuring unit.
- Statistics for the measurement data from the chosen measuring unit.

REPORT

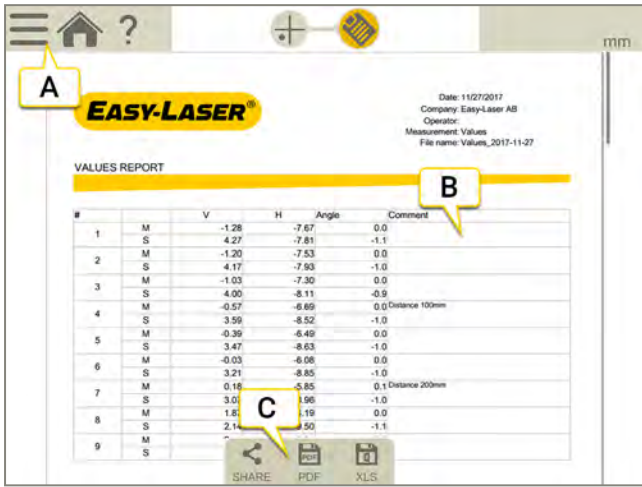
The report covers all details from the measurement. The report is constantly being filled out while the session is carried out. To see the report at its current state, tap  in the workflow.



- A. Tap  and  to finalize the measurement. See "Finalize" on page 8
- B. Comments made are visible here. To add a note for the whole measurement, tap .
- C. Save as a Pdf or Excel file. The files are saved in the File manager. The functions Share and Save as Pdf or Excel file are available after the measurement has been finalized.

For information on how to:

- Change the template
- Add a note
- Add a photo
- Change user information
- Save a report
- Share a report to USB

See " Report Overview" on page 14

CALIBRATION CHECK

Use the program Values to check if the detector readings are within specified tolerances.

Quick check

1. Make a mark to mark out the position of the detectors.
2. Tap **0** to zero set the value.
3. Place a shim under the magnet base to lift the M-unit 1 mm (100 mils). The M-unit's reading shall correspond to the movement within 1 % (± 1 mil or ± 0.01 mm).
4. Remove the shim from the M-unit.
5. Tap **0** to zero set value.
6. Place the shim under the magnet base of the S-unit. The S-unit's reading shall correspond to the movement within 1 % (± 1 mil or ± 0.01 mm).

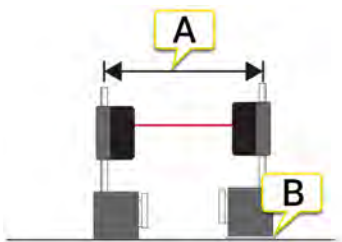

- A. Make sure that the distance is kept.
- B. Parallel lift to a known distance. Shim exactly 1 mm (100 mils).

NOTE! The shim must be exactly 1 mm (100 mils).

Precision check

1. Fasten one of the measuring units in a machine tool.
2. Tap **0** to zero set value.
3. Move the unit a known distance. Use the movement of a machine tool spindle.
4. The fastened unit's reading shall correspond to the movement within 1 %.

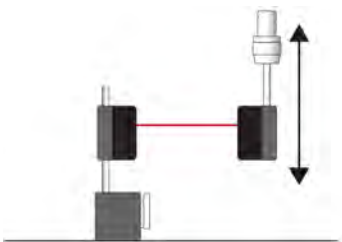

Move the unit a known distance.

NOTE! In this example it is only the unit fastened in the machine that is checked.

EASYTREND



OVERVIEW EASYTREND

Makes it possible to keep track of machine movement over time. You can check for example thermal expansion and pipe strain issues.

Measuring units that can be used: only XT70.

Workflow EasyTrend



The workflow on the top of the screen will guide you through your work. The current view is marked yellow. The report is constantly being filled out while the session is carried out. To see the report at its current state tap  in the workflow. The measurement is saved automatically through the entire workflow.

When you have finished the measurement, tap  and  to finalize it.



Prepare view is active in the workflow

Create a template

1. Tap  and .
2. Enter a new name or keep the default name. The template is saved in the File manager.

See "Templates for measurements" on page 12.

DM BRACKET

The DM bracket (art. no 12-1130) can be used to measure dynamic movements. The bracket is fastened on the machine with glue or screws.

Mount the bracket

1. Mount a measurement unit in the bracket.
2. Fasten the unit with the screws on the rods. (Do not use the screws on the measuring units.)
3. Decide where to place the bracket. Place it on the same height as the shaft center.
4. Use a bolt or glue mounting plate to fasten the bracket.

Glue

5. Remove paint on the machine.
6. Clean the surface.
7. Put on gloves and protective glasses.
8. Apply glue (Loctite HY4070 or similar) on the bracket and place it on the machine.

Fixing time 5 minutes. Full strength after 24 hours.

NOTE! Handle the glue with precaution, read the instruction delivered together with the DM bracket.

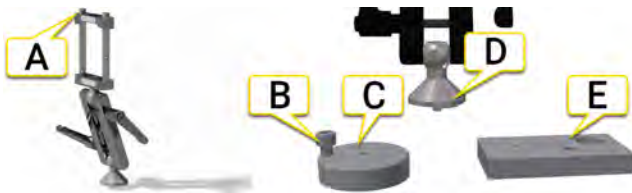

- A. Screws to fasten the measurement unit.
- B. Use this to break away the glue mounting plate.
- C. Glue mounting plate.
- D. Fasten on glue OR bolt mounting plate.
- E. Bolt mounting plate.

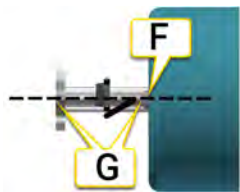

- F. Remove paint and clean the surface
- G. Place the bracket on the same height as the shaft center.

PREPARE

1. Tap a target to connect measuring units.
2. Enter distances.
3. Tap  to go to Measure.

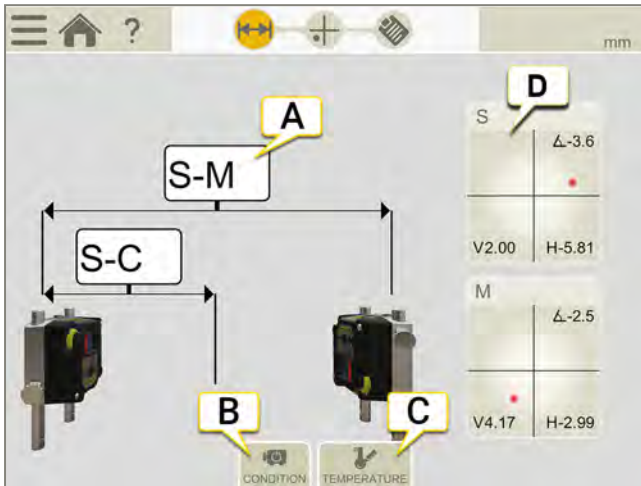

- A. Tap to enter distances.
- B. Machine condition.
- C. Machine temperature.
- D. Tap to select detector.

Machine condition

- Offline to running. Default setting. The machine is offline when you start the measurement, you start it and stop measuring when the operating condition is reached.
- Running to offline. Start the measurement when the machine is in full operation condition. Stop after the machine has reached ambient temperature.
- Not specified.



Machine temperature

You can enter start and stop temperature. The information is optional and shown in the report.

NOTE! This information is only used for documentation and is not used for any calculations.

To change between Celsius or Fahrenheit, See "Units" on page 16

MEASURE

1. Tap  to start a measurement.
2. Tap  to stop.
3. The result shows the difference between the first and last measurement.

It is not possible to restart the measurement when it has been stopped. If you tap , you will start a new measurement.

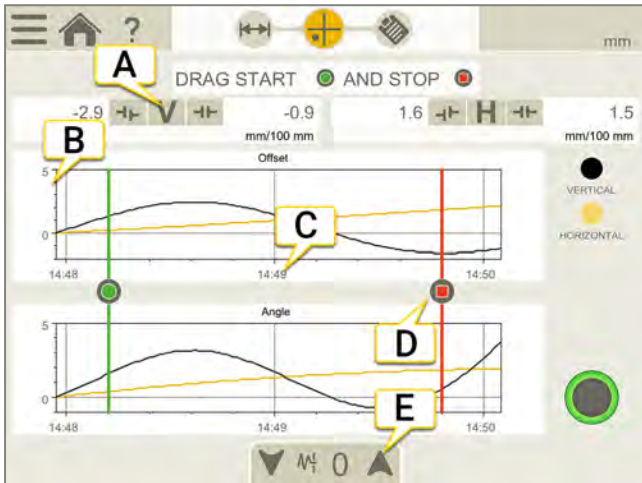

- A. Vertical and horizontal result.
- B. Starts with showing ± 0.1 mm. It will scale when needed.
- C. Time axis is marked with one minute interval.
- D. Start and stop icons.
- E. See "Filter" on page 8

Change start and stop time

When you have stopped the measurement, it is possible to change the start and stop time.



If you move the start and stop, the result will change. The result shows the difference between the first and last measurement.

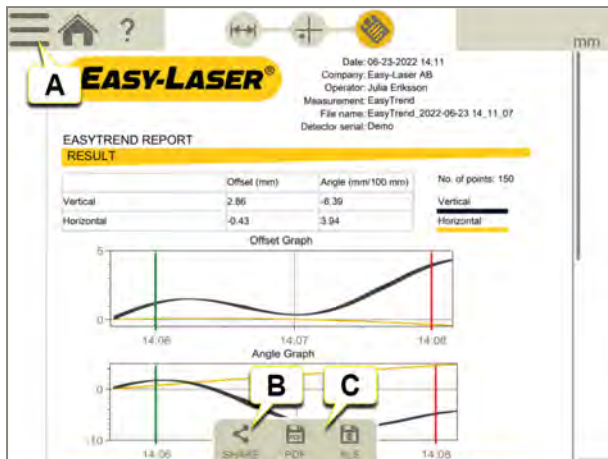

Start and stop icons

EASY TREND REPORT



- Tap  and  to finalize the measurement. See "Finalize" on page 8
- Share the report.
- Save as a Pdf or Excel file. The files are saved in the File manager. The functions Share and Save as Pdf or Excel file are available after the measurement has been finalized.

For information on how to:

- Change the template
- Add a note
- Add a photo
- Change user information
- Save a report
- Share a report to USB

See " Report Overview" on page 14.

HORIZONTAL

OVERVIEW HORIZONTAL







This program is used for horizontally mounted machines.

Measuring units that can be used

	XT70	XT60	XT50	XT40
Horizontal (EasyTurn or 9-12-3)	X	X	X	X
Horizontal (Multi or Sweep)	X	X	X	



The live option "Live360" is only available when using **XT70**.

Measuring methods

	EasyTurn™ The EasyTurn™ function allows you to begin the measurement process from anywhere on the turn. You can turn the shaft to any three positions with as little as 20° between each position to register the measurement values. An easier-to-use version of the 9–12–3 method.
	9-12-3 Measurement points are recorded at fixed points 9, 12 and 3 o'clock. This is the classic three-point method which can be used in most cases.
	Continuous sweep Automatic recording of measurement values during continuous sweeping of the shaft. Hundreds of points are registered. You can start anywhere on the turn. Quality check of measurement is provided.
	Multipoint Multipoint is basically the same as EasyTurn™, but instead you can record multiple points on the sector rotated. This will provide an optimized calculation basis. Perfect for e.g. turbine and sliding bearing applications.
	Uncoupled sweep Recording of measurement values on shafts that are so heavy or hard to rotate that slings or auxiliary slow turning motor may be required to perform rotation.
	Create a template 1. Tap  and  . 2. Enter a new name or keep the default name. The template is saved in the File manager. See "Templates for measurements" on page 12.

Workflow Horizontal

The workflow on the top of the screen will guide you through your work. The current view is marked yellow. The report is constantly being filled out while the session is carried out. To see the report at its current state tap  in the workflow. The measurement is saved automatically through the entire workflow.

When you have finished the measurement, tap  and  to finalize it.

HORIZONTAL



Prepare view is active in the workflow

PREPARE

First you need to set up and rough align the measuring units:

- See "Set up XT40" on page 41
- See "Set up XT50" on page 45
- See "Set up XT60" on page 47
- See "Set up XT70" on page 49

On the Prepare view, you enter machine and coupling properties. It is possible to go back to the Prepare view later and enter/alter information. Tap **+** to display a property menu for the Coupling or the Machine.

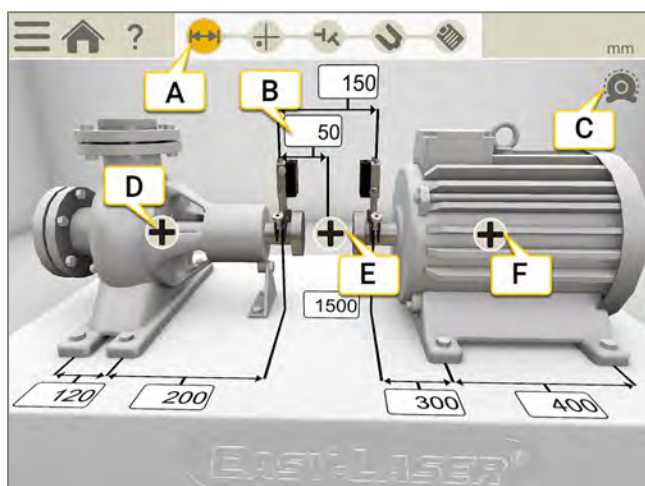

- The Prepare icon is active in the workflow.
- Tap any input field to enter distance.
- Thermal compensation has been set.
- Machine properties S, see links below.
- Coupling properties, see links below.
- Machine properties M, see links below.
- Tap any input field to enter distance.

Machine properties

	Name See "Name the machine" on page 161
	Configuration: Change machine image, change number of feet See "Configuration" on page 160
	Lock feet See "Locked feet" on page 81
	Show distances See "Enter distances" on page 77
	Thermal compensation. Set compensation on feet See "Thermal compensation " on page 82





Coupling properties

	RPM See "RPM Horizontal" on page 79
	Tolerance See "Tolerance" on page 80
	Thermal compensation. Set compensation on coupling See "Thermal compensation " on page 82
	Coupling diameter See "Coupling setup" on page 79
	Coupling type See "Coupling setup" on page 79

NOTE! Make sure that the measuring units are changed.

Menu icons

Tap  to open the menu.

	Mirror the machines.
	Show Gap. If you want the result based on the gap of the coupling instead of angle, it is necessary to enter the coupling diameter.
	Add a note to the report.
	See "XT Display Unit Camera" on page 32
	Finalize the measurement. See "Finalize" on page 8.

Enter distances

Tap any distance input field to enter distance. The field is zoomed in and the keyboard is displayed.

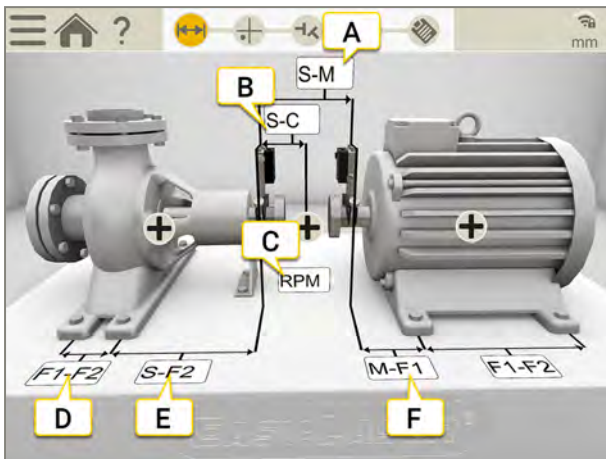

- A. Distance between S-unit and M-unit. Measure between the rods.
- B. Distance between S-unit and center of coupling.
- C. RPM. When you enter RPM, a corresponding tolerance is automatically selected.
- D. Distance between first and second foot. To enter distances on the S-machine, tap **+** and **↔** to display the fields.
- E. Distance between second foot and S-unit.
- F. Distance between M-unit and foot one. It is possible to enter a negative value here.

Required distances

It is possible to skip all distances and go directly to Measure view. If you change a distance later on, the result is recalculated.

- To calculate an offset and angle result, you need to enter at least the distances between S and M.
- Feet values can only be calculated if you have entered the distance between the feet.

Configuration

On the machine, tap **+** and **⚙️** to open the Configuration view.

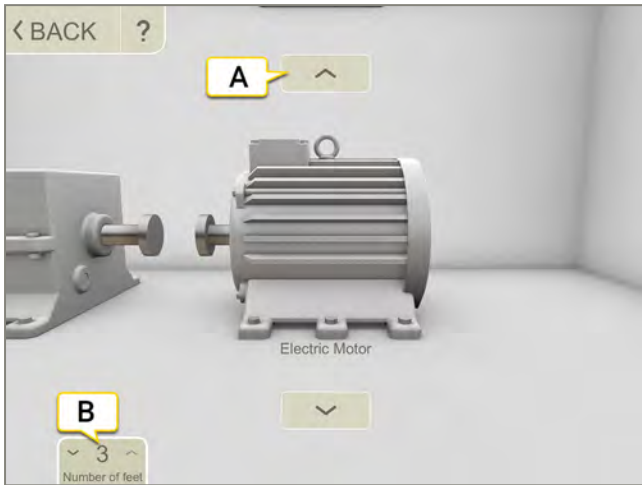

- A. Tap arrows change the machine image.
- B. Tap to change the number of feet. The possible number of feet varies depending on machine.

Name the machine

Use if you want to change the default names on the machines. The name is visible in the report.

1. Tap **+** on the machine.
2. Tap **🔑**.
3. Tap the text input field to change the name.

Coupling setup

Coupling type

1. On the coupling, tap **+**.
2. Tap .
3. Select coupling type.

Coupling diameter

If you want the result based on the gap of the coupling instead of angle, it is necessary to enter the coupling diameter. The coupling diameter is visible in the report.

1. On the coupling, tap **+**.
2. Tap .
3. Enter the diameter.

Gap

To show the result as gap, tap  and .

Angle/Angle or Offset/Offset

In result view you can choose either Angle/Angle or Offset/Offset view.

To be able to do this you must first select Angle/Angle or Offset/Offset in the Prepare step.



- A. Tap to open Coupling properties.
- B. Tap Coupling type.
- C. Tap Offset/Offset (or Angle/Angle).

RPM Horizontal

The rotation speed of the shafts will decide the demands on the alignment. When you select a rpm value, a matching tolerance is set automatically.

The higher the rpm of a machinery is, the tighter the tolerance must be.

1. Tap the RPM field to enter a value. Or tap **+** and  on the coupling.
2. Enter RPM. A tolerance is automatically set to match the RPM you entered.

See "Tolerance" on the next page

Tolerance

The rotation speed of the shafts will decide the demands on the alignment. When you select a rpm value, a matching tolerance is set automatically.

The higher the rpm of a machinery is, the tighter the tolerance must be.

1. On the coupling, tap **+**.
2. Tap **ii** to display the tolerance menu.

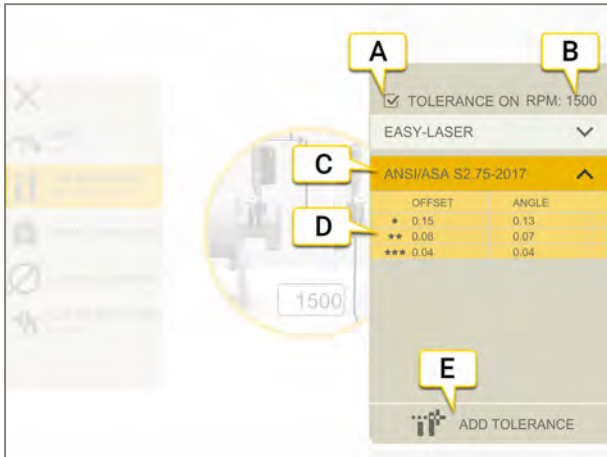

- A. Turn tolerance on/off.
- B. Current RPM.
- C. Selected tolerance.
- D. Tolerance levels.
- E. Add custom tolerance.

Built-in tolerances

The system comes with two built-in tolerances, *Easy-Laser Standard* and *ANSI standard*.

The system remembers which tolerance was last selected and will use that tolerance as the default selection when a new measurement session is created. When you set an RPM value, the tolerance is activated.

Easy-Laser

The tolerance level "good" is used for re-alignments on non-critical machinery. New installations and critical machines should always be aligned within the tolerance level "excellent".

There are two tolerance levels:

	Indicates not within tolerance. Red background.
	Good. Yellow background.
	Excellent. Green background.



ANSI standard

The ANSI/ASA S2.75-2017 standard is available. This standard has three tolerance levels:

	Indicates not within tolerance. Red background.
	Minimal. Orange background.
	Standard. Yellow background.
	Precision. Green background.

Custom tolerance

Many machines must be aligned very accurately even if they have a lower rpm. You can add your own user defined tolerance.

1. Tap .
2. Enter offset and angle values.
3. Tap  to add the custom tolerance.

There are two tolerance levels for custom tolerances.



Spacer shaft tolerance

If you have selected spacer shaft, no offset tolerance is used. Both angles (A and B) are compared and have to be within tolerance.

Locked feet

Locked feet is available in the result view, both from Machine and Graph view.

This function is useful in cases when a foot is difficult or impossible to adjust. The Lock feet function allows you to select which feet that are locked and which that are adjustable. To display feet values on a machine with locked feet, you need to enter the distances.

1. Tap  on the tab in the result view.
2. Tap one or two fields to lock the corresponding feet. If you want to move a lock, simply tap it to unlock and then tap in another field.
3. Tap  when you are done.

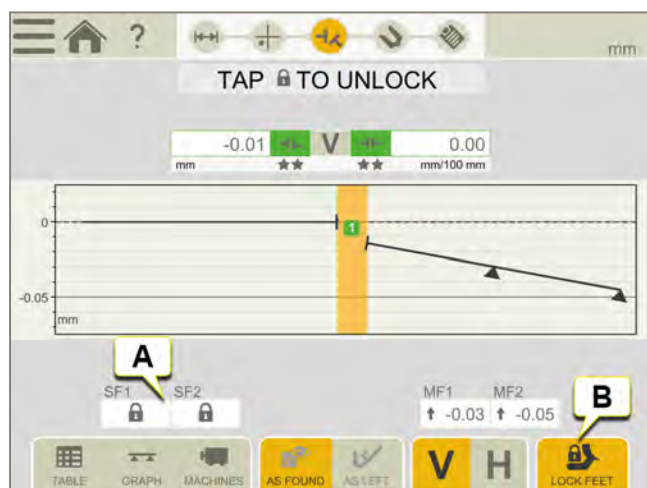

- A. Tap lock to unlock.
- B. Tap to finish.

NOTE! To display feet values on a machine with locked feet, you need to enter the distances.

Thermal compensation



During normal operation, machinery is influenced of different factors and forces. The most common of these changes is the change in the temperature of the machine. This will cause the height of the shaft to increase. This is called thermal growth. To compensate for thermal growth, you enter values for cold condition compensation. It can be necessary to place the offline (cold) machine a bit lower to allow thermal growth.

To compensate for thermal growth, offset and angle values are used. The offset and angle values are based on a calculation point:

- For short flex, the calculation point is in the center of the coupling.
- For spacer shaft, the calculation point is on the left side of the spacer.

It is **not** possible to have both coupling and feet compensation on the same machine.

Set compensation on the coupling

1. Tap **+** on the coupling.
2. Tap  to open the Thermal Compensation view.
3. Enter values for Vertical and/or Horizontal compensation. When you enter compensation values, the machine turns blue.
4. Tap  to return to Prepare view.

The compensation values are visible in the report.

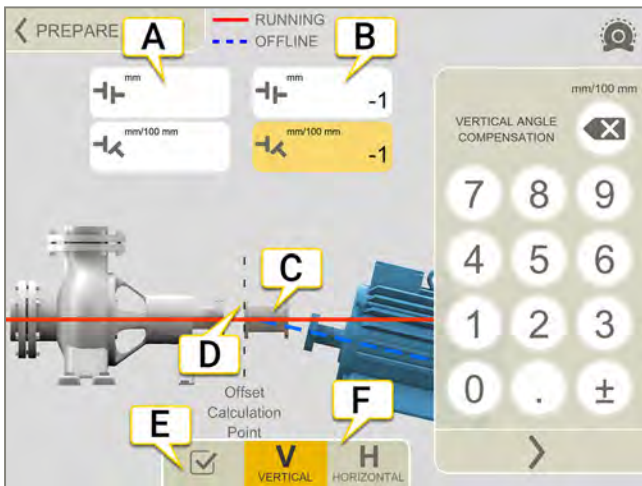



- A. Offset and angle values for the left machine.
- B. Offset and angle values for the right machine.
- C. Spacer shaft.
- D. Calculation point is on the left side of the spacer.
- E. Turn Thermal compensation on/off. If you turn it off, the values are saved but will not be used. In Machine train, this will affect **all** couplings in the train.
- F. Show V (vertical) or H (horizontal) view.

NOTE! It is **not** possible to have both coupling and feet compensation on the same machine.

Set compensation on feet

Values are entered on the first and last foot on the machine. If the machine has more than two feet, calculated values on these are presented in the report.

1. Enter distances.
2. Tap **+** on the machine.
3. Tap  to open the Thermal Compensation view.
4. Enter values for Vertical and/or Horizontal compensation. When you enter compensation values, the machine turns blue.
5. Tap  to return to Prepare view.

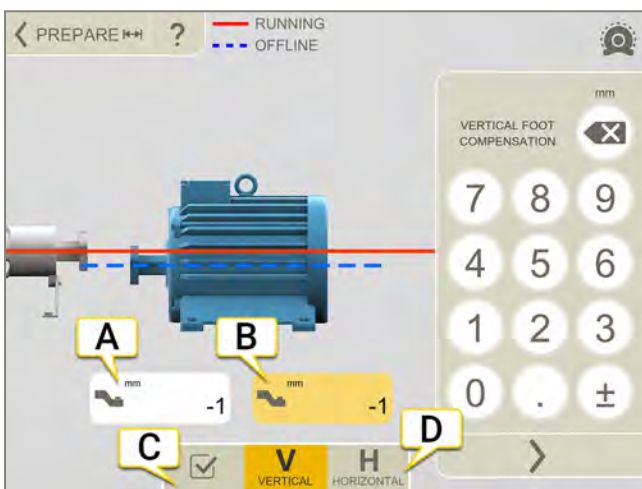

- A. Feet value for the first foot.
- B. Feet value for the last foot.
- C. Turn Thermal compensation on/off. If you turn it off, the values are saved but will not be used. In Machine train, this will affect **all** couplings in the train.
- D. Show V (vertical) or H (horizontal) view.

NOTE! It is **not** possible to have both coupling and feet compensation on the same machine.

HORIZONTAL

Example without compensation

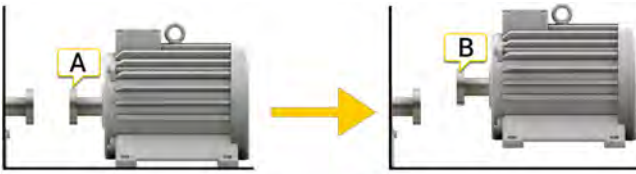

- A. Offline, no compensation set. The machines are aligned.
- B. Running, the machine "grows" 5 mm, and is no longer aligned.

Example with compensation

In this example we assume a thermal growth of +5 mm in HOT condition. Therefore we compensate with -5 mm in offline condition.

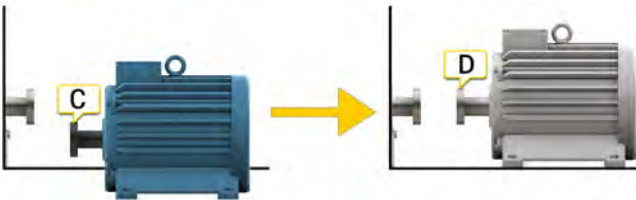

- C. Offline, a -5 mm compensation has been set.
- D. Running, the machine grows and will be perfectly aligned!

MEASURE USING EASYTURN™

Measuring units that can be used: XT40, XT50, XT60 and XT70

With EasyTurn™, it is possible to measure with as little as 40° spread between the measurement points. However, for an even more accurate result, try to spread the points as much as possible.







Preparations

Before you start measuring, make sure you have done the preparations you need.

- Mount the measuring units.
- To calculate results, you need to enter at least the distance between the measuring units.
- Tap a target to connect measuring units. See "Select measuring units" on page 37.
- If needed, perform a rough alignment.
- If needed, measure Softfoot. See "Softfoot" on page 1

Measure

It is possible to switch measuring method before you have registered a value.

1. Tap  on the tab to select the method EasyTurn.
2. Adjust laser to the center of the targets. If needed, adjust the units on the rods, then use laser adjustments knobs.
3. Tap  to register the first position. A red marking is displayed.
4. Turn the shafts at least 20°.
5. Tap  to register the second position.
6. Turn the shafts at least 20°.
7. Tap  to register the third position.
8. Tap  to go to the Result view, or tap  to measure again.



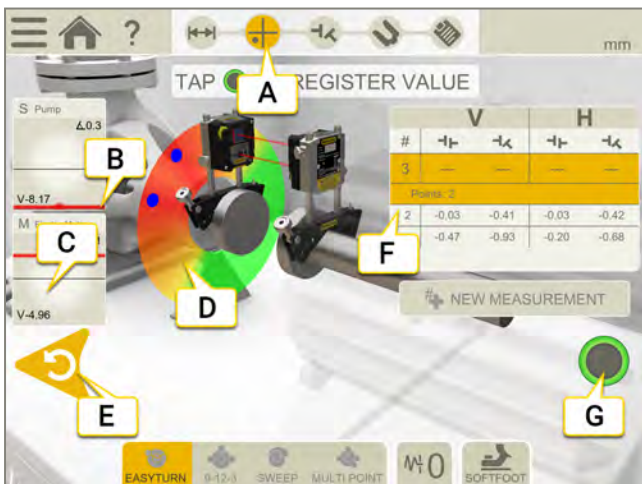



The registered values are saved when you leave the Measure view. If you return to the Measure view, it is possible to do a new measurement.



- A. The Measure icon is active in the workflow.
- B. Edge warning. When the laser beam is close to the edge, the edge is "lit up" as a warning. It is still possible to register values when the edge warning is active.
- C. Tap to select detector.
- D. Red = turn shafts outside the red marking.
Green = turn shafts to green area.
Blue = registered position.

HORIZONTAL

- E. Delete registered value.
- F. Measurement table. If you have selected spacer shaft, see information below.
- G. This icon is gray when it not possible to register a value.

	Make a new measurement. This makes it possible to check the repeatability of the measurement.
	Measure using EasyTurn™.
	Measure using 9-12-3.
	Measure using Multipoint.
	Measure using Continuous sweep.
	Set Filter value.
	Measure Sofffoot.



Spacer shaft in measurement table



- A. Vertical values for angle A and B
- B. Horizontal values for angle A and B

Zero inclinometer

If the machine is mounted on an inclined base plane, you can manually set the inclinometer to a new 12 o'clock position. The following measurements will then use the new inclinometer settings.

1. Choose the measuring method you want to use.
2. Turn the measuring units so that the rods are perpendicular to the base plane.
3. Tap  and .
4. Confirm the desired position for the measuring units by tapping . The inclinometer will now be set to zero.

Your inclinometer adjustment will be applied during the whole measurement session, but will be restored when you start a new measurement from the start menu.

MEASURE USING 9-12-3

Measuring units that can be used: XT40, XT50, XT60 and XT70.

The measuring positions are registered at positions 9, 12, 3 o'clock. The inclinometers are not used.







Preparations

Before you start measuring, make sure you have done the preparations you need.

- Mount the measuring units.
- To calculate results, you need to enter at least the distance between the measuring units.
- Tap a target to connect measuring units. See "Select measuring units" on page 37
- If needed, perform a rough alignment.
- If needed, measure Softfoot, See "Softfoot" on page 1.

Measure

It is possible to switch measuring method before you have registered a value.

1. Tap  on the tab to select the method 9-12-3.
2. Adjust laser to the center of the targets. If needed, adjust the units on the rods, then use laser adjustments knobs.
3. Turn shafts to 9 o'clock.
4. Tap  to register the first position.
5. Turn shafts to 12 o'clock.
6. Tap  to register the second position.
7. Turn shafts to 3 o'clock.
8. Tap  to register the third position.
9. Tap  to go to the Result view, or tap  to measure again.

The registered values are saved when you leave the Measure view. If you return to the Measure view, it is possible to do a new measurement.

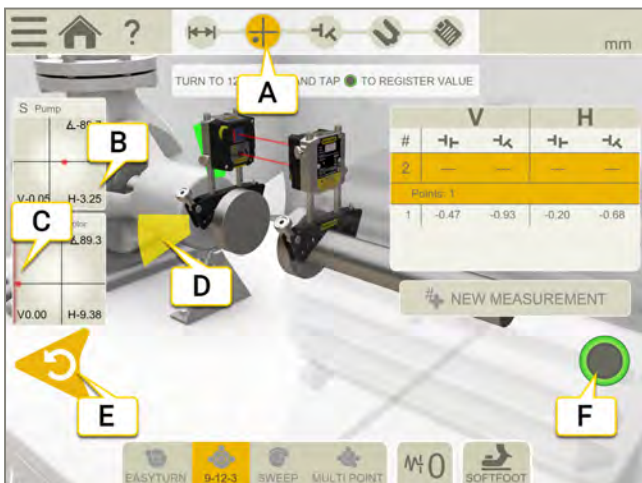

- A. The Measure icon is active in the workflow.
- B. Tap to select detector.
- C. Edge warning. When the laser beam is close to the edge, the edge is "lit up" as a warning. It is still possible to register values when the edge warning is active.
- D. Yellow = registered position.
Green = turn shafts to green area.

HORIZONTAL

- E. Delete registered value.
- F. Tap to register value.

#+	Make a new measurement. This makes it possible to check the repeatability of the measurement.
	Measure using EasyTurn™.
	Measure using 9-12-3.
	Measure using Multipoint.
	Measure using Continuous sweep.
	Set Filter value.
	Measure Softfoot.

Spacer shaft in measurement table



- A. Vertical values for angle A and B
- B. Horizontal values for angle A and B

MEASURE USING MULTIPOINT

Measuring units that can be used: XT50, XT60 and XT70

Preparations





Before you start measuring, make sure you have done the preparations you need.

- Mount the measuring units. "Multipoint" is available when you use XT60 measuring units.
- To calculate results, you need to enter at least the distance between the measuring units.
- Tap a target to connect measuring units. See "Select measuring units" on page 37
- If needed, perform a rough alignment.
- If needed, measure Softfoot. See "Softfoot" on page 1.

Measure

It is possible to switch measuring method before you have registered a value.

For a more accurate result, try to spread the points as much as possible. The colors indicates where the optimum positions to measure are. Green is best place to measure. Always turn the shaft in the same direction for a more accurate result.

1. Tap  on the tab to select the method Multipoint.
2. Adjust laser to the center of the targets. If needed, adjust the units on the rods, then use laser adjustments knobs.
3. Tap  to register the first position. The first position is automatically set to zero.
4. Tap  to register as many positions as you wish. After three points a result is available.
5. Tap  to go to the Result view, or tap  to measure again.

The registered values are saved when you leave the Measure view. If you return to the Measure view, it is possible to do a new measurement.

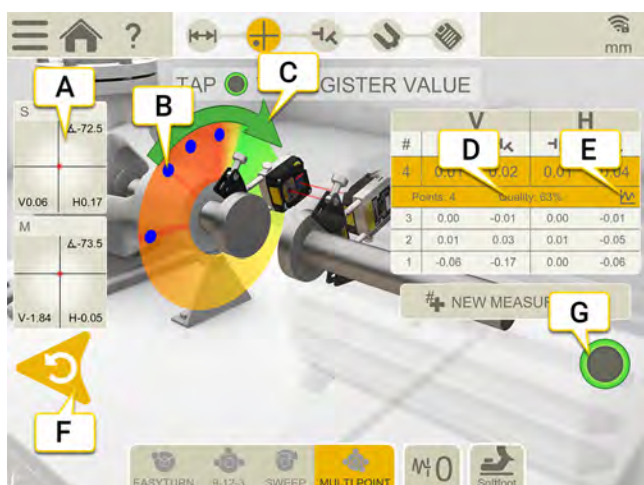







- A. Tap to select detector.
- B. Registered measurement point.
- C. Measurement direction.
- D. Quality assessment.
- E. Tap  to show detailed information. See "Result details" on page 101.
- F. Delete registered value.
- G. Tap to register values.



Make a new measurement. This makes it possible to check the repeatability of the measurement.

HORIZONTAL

	Measure using EasyTurn™.
	Measure using 9-12-3.
	Measure using Multipoint.
	Measure using Continuous sweep.
	Set Filter value.
	Measure Softfoot.

Spacer shaft in measurement table





- A. Vertical values for angle A and B
- B. Horizontal values for angle A and B

Edge warning

When the laser beam is close to the edge, the edge is “lit up” as a warning. It is still possible to register values when the edge warning is active.

Zero inclinometer

If the machine is mounted on an inclined base plane, you can manually set the inclinometer to a new 12 o'clock position. The following measurements will then use the new inclinometer settings.

1. Choose the measuring method you want to use.
2. Turn the measuring units so that the rods are perpendicular to the base plane.
3. Tap  and .
4. Confirm the desired position for the measuring units by tapping . The inclinometer will now be set to zero.

Your inclinometer adjustment will be applied during the whole measurement session, but will be restored when you start a new measurement from the start menu.

MEASURE USING CONTINUOUS SWEEP

Measuring units that can be used: XT50, XT60 and XT70

Automatic recording of measurement values during continuous sweeping of the shaft.

There is no limit on the number of points.





Preparations

Before you start measuring, make sure you have done the preparations you need.

- Mount the measuring units. "Continuous sweep" is available when you use XT60 measuring units.
- To calculate results, you need to enter at least the distance between the measuring units, see "Enter distances" on page 77.
- Tap a target to connect measuring units. See "Select measuring units" on page 37.
- If needed, perform a rough alignment.
- If needed, measure Softfoot. See "Softfoot" on page 1.

Measure

It is possible to switch measuring method before you have registered a value. Filter is **not** available when you measure with Sweep.





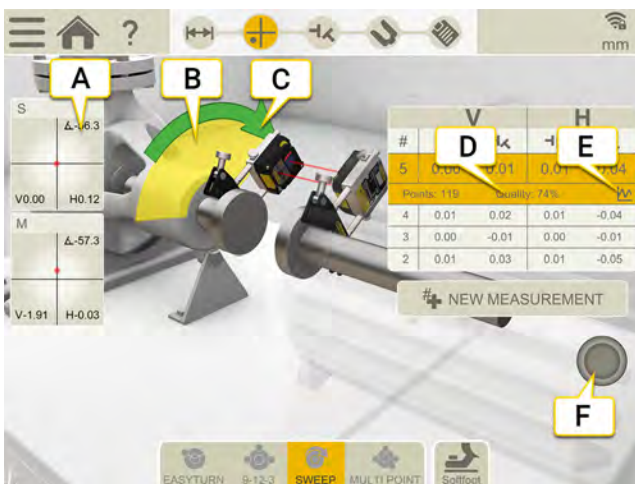

1. Tap  on the tab to select the method Continuous sweep.
2. Adjust laser to the center of the targets. If needed, adjust the units on the rods, then use laser adjustments knobs.
3. Tap  to start the measurement.
4. Turn the shafts. Turn the shafts as much as possible for a more accurate result.
5. Tap  to stop the measurement.
6. Tap  to go to the Result view, or tap  to measure again.

The registered values are saved when you leave the Measure view. If you return to the Measure view, it is possible to do a new measurement.



- A. Tap to select detector.
- B. Yellow area is where points have been registered.
- C. Measurement direction. If you change direction during the measurement, the arrow turns red.
- D. Quality assessment.
- E. Tap  to show detailed information. See "Result details" on page 101.
- F. Tap to start and stop the measurement.

HORIZONTAL

	Make a new measurement. This makes it possible to check the repeatability of the measurement.
	Measure using EasyTurn™.
	Measure using 9-12-3.
	Measure using Multipoint.
	Measure using Continuous sweep.
	Measure Softfoot.

Spacer shaft in measurement table





- A. Vertical values for angle A and B
- B. Horizontal values for angle A and B

Edge warning

When the laser beam is close to the edge, the edge is “lit up” as a warning. It is still possible to register values when the edge warning is active.

Zero inclinometer

If the machine is mounted on an inclined base plane, you can manually set the inclinometer to a new 12 o'clock position. The following measurements will then use the new inclinometer settings.

1. Choose the measuring method you want to use.
2. Turn the measuring units so that the rods are perpendicular to the base plane.
3. Tap  and .
4. Confirm the desired position for the measuring units by tapping . The inclinometer will now be set to zero.

Your inclinometer adjustment will be applied during the whole measurement session, but will be restored when you start a new measurement from the start menu.

MEASURE USING UNCOUPLED SWEEP

Measuring units that can be used: XT50, XT60 and XT70.

Purpose: Recording of measurement values on shafts that are so heavy or hard to rotate that slings or auxiliary slow turning motor may be required to perform rotation.





Preparations

Before you start measuring, make sure you have done the preparations you need.

- Mount the measurement units on the disconnected couplings or directly on the shafts.
- To calculate results, you need to enter at least the distance between the measuring units. See "Enter distances" on page 77
- Tap a target to connect measuring units. See "Select measuring units" on page 37
- If needed, perform a rough alignment.

• Measure

It is possible to switch measuring method before you have registered a value. Filter is **not** available when you measure with Uncoupled Sweep.

1. Tap  on the tab to select the method Uncoupled sweep.
2. Adjust laser to the center of the targets. If needed, adjust the measurement units on the rods, then use laser adjustments knobs.
3. Tap  to start the measurement. A first measurement point will be recorded at this position.
4. Rotate one of the shafts to the desired position and then slowly rotate the opposite shaft to pass the position of the first measurement unit. A measurement point will automatically be recorded at this position.
5. Rotate the shafts, one after another, to different positions, preferably until a full revolution is completed.
6. Every sweep gives one measurement point.
7. At least three measurement points are required, but you can register as many as you wish.
8. Tap  to stop the measurement.
9. Tap  to go to the Result view, or tap  to measure again.

The registered values are saved when you leave the Measure view. If you return to the Measure view, it is possible to do a new measurement.

If you have registered less than three values and end the program (e.g. by exiting the app or selecting Main menu) or leave the Measure view during ongoing measuring, you will lose your registered values.

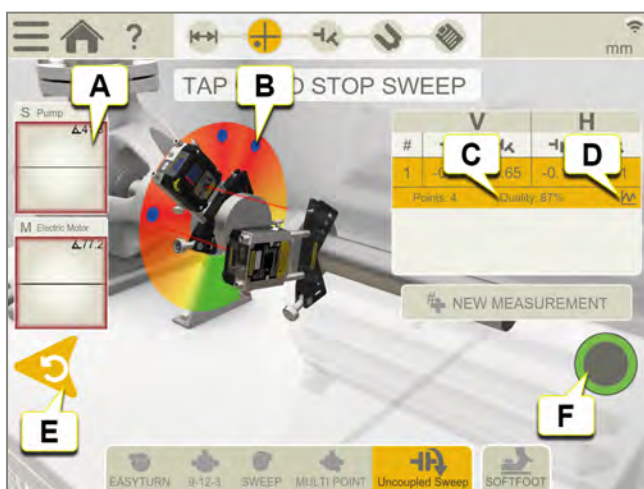







HORIZONTAL

- A. Tap to select detector.
- B. Registered measurement point.
- C. Quality assessment.
- D. Tap  to show detailed information. See "Result details" on page 101.
- E. Delete registered value.
- F. Tap to start and stop the measurement.

NOTE! If sweeping rotation is too fast to register a value, the software will request that you slow it down.

NOTE! Sweeping rotation must be extra slow if you are running the XT app on Ecom Tab-EX 01 due to lower performance on this unit.



	Make a new measurement. This makes it possible to check the repeatability of the measurement.
	Measure using EasyTurn™.
	Measure using 9-12-3.
	Measure using Multipoint.
	Measure using Continuous sweep.
	Measure using Uncoupled sweep.
	Measure Softfoot.

Edge warning

When the laser beam is close to the edge, the edge is "lit up" as a warning. It is still possible to register values when the edge warning is active.

Zero inclinometer

If the machine is mounted on an inclined base plane, you can manually set the inclinometer to a new 12 o'clock position. The following measurements will then use the new inclinometer settings.

1. Choose the measuring method you want to use.
2. Turn the measuring units so that the rods are perpendicular to the base plane.
3. Tap  and .
4. Confirm the desired position for the measuring units by tapping . The inclinometer will now be set to zero.

Your inclinometer adjustment will be applied during the whole measurement session, but will be restored when you start a new measurement from the start menu.





SOFTFOOT

Perform a softfoot check to ensure that the machine is resting evenly on all its feet. A softfoot can be angular and/or parallel. Softfoot can be caused by:

- Twisted machinery foundations.
- Twisted or damaged machinery feet.
- Improper amount of shims under machine feet.
- Dirt or other unwanted materials under machine feet.

Measure

Softfoot can be checked on all machines on which you have entered distances.

1. Enter distances between the measuring units and the feet. This is done on the Prepare view.
2. On the Measure view, tap  on the tab.
3. Place the detectors at 12 o'clock and rough align if needed.
4. Tap  in the workflow.
5. Tap any of the feet value boxes.
6. Loosen bolt and wait for movement. Check the graph to see when the value has stabilized.
7. Tighten the bolt and wait for the value to stabilize again.
8. Tap  to register value.
9. Tap another foot to measure. Tap  to show the Softfoot result.
10. Tap  to return to the Measure view.

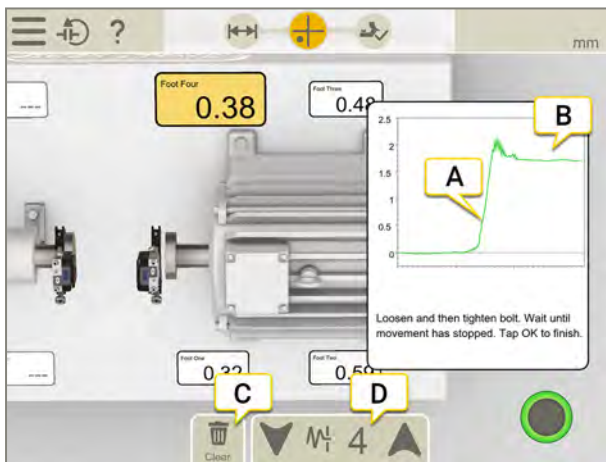

- A. Loosen bolt and wait for movement.
- B. Movement has stabilized. Tighten the bolt.
- C. Tap if you want to clear all softfoot values.
- D. Filter.

Filter

If you have a low filter, the detector filter is increased to filter 4 when you measure Softfoot. If you increase the filter setting while measuring Softfoot, the new filter will be default next time you start Softfoot.

RESULT

In the Result view, the offset, angle and feet values are clearly displayed. Both horizontal and vertical directions are shown. Toggle to choose separate V or H view, or a combined V/H view. You can go back and forth between the views Measure, Result and Adjust.

Tap  if you want to adjust the machine. After you have adjusted, it is possible to go back to the Result view.

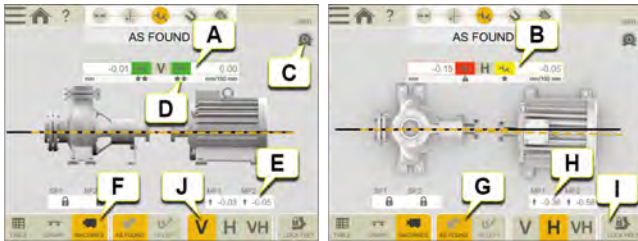

- A. Vertical offset and angle values. For spacer shaft: See "Spacer shaft result" on the facing page.
- B. Horizontal offset and angle values.
- C. Thermal compensation has been set.
- D. Tolerance indicators.
- E. Vertical feet values. If you have locked a foot, this is visualized with a lock .
- F. Show Table or Machine view. See "Result table" on page 100.
- G. Show "As found" or "As left" values.
- H. Horizontal feet values.
- I. Lock feet. See "Locked feet" on page 81.
- J. Toggle to choose vertical or horizontal view.

NOTE! When you have locked feet, both machines are displayed and you have to toggle between V and H values.

How to read the values

When reading the values, face the stationary machine (S) from the movable machine (M). Then 9 o'clock is to the left, as in the measuring programs.

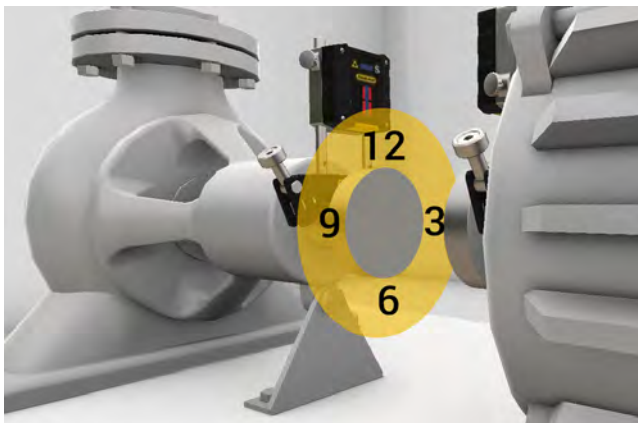

As found or As left

On the tabs, it is possible to toggle between showing As found or As left values.

 As found is the latest measurement you made before making an adjustment.



As left is the latest adjusted result. Available if you have gone to the Adjust view (and shown live values) and returned to Result view.

Show Gap

By default, angular error/100 mm is displayed. To show gap, you need to set the coupling diameter.

To show the result as gap, tap and .

NOTE! For some machine configurations the 3D result may not be accurate. It is intended as a guide and may not always show the right rotation and position of the machine. The displayed values for feet and coupling errors are always accurate and should be followed in the event that the 3D result indicates otherwise.

Offset and angle values

The offset and angle value indicate how well the machine is aligned at the coupling. They appear in both horizontal and vertical direction. These values are important to get within tolerance.

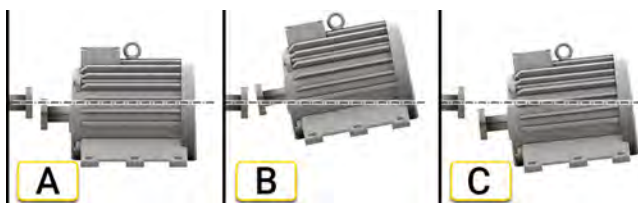

- A. Offset. The center lines of two axis are not concentric but parallel. This is measured at the coupling centers. In this example, a negative offset is shown.
- B. Angular misalignment. The center lines of two axis are not parallel. In this example, a positive angle is shown.
- C. Offset and angular misalignment. Misalignment is often a combination of both offset and angular misalignment.

Spacer shaft result

If you have selected spacer shaft, values for angle A and B are displayed. They appear in both horizontal and vertical direction.

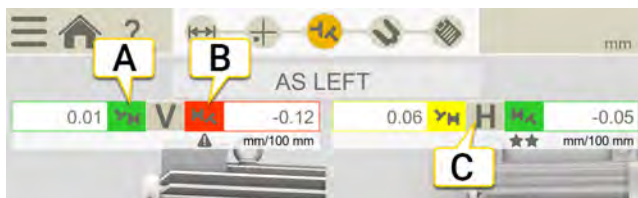

- A. Vertical values for angle A.
- B. Vertical values for angle B.
- C. Horizontal values.

Angle A and angle B

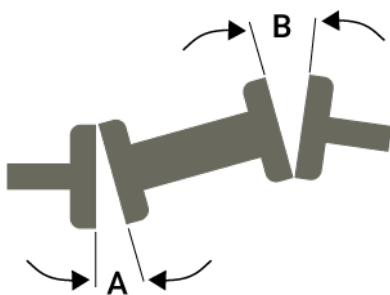

HORIZONTAL

Spacer shaft result Offset/Offset

If you have selected spacer shaft Offset/Offset, values for offset A and offset B are displayed. They appear in both horizontal and vertical direction.

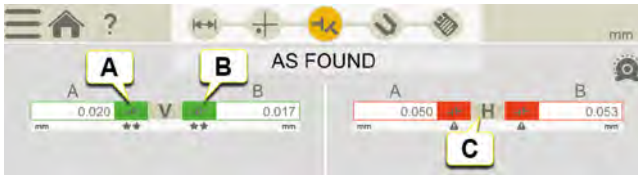

- A. Vertical values for Offset A.
- B. Vertical values for Offset B.
- C. Horizontal values.

Offset A and Offset B

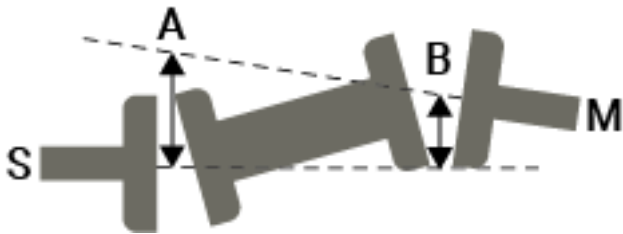



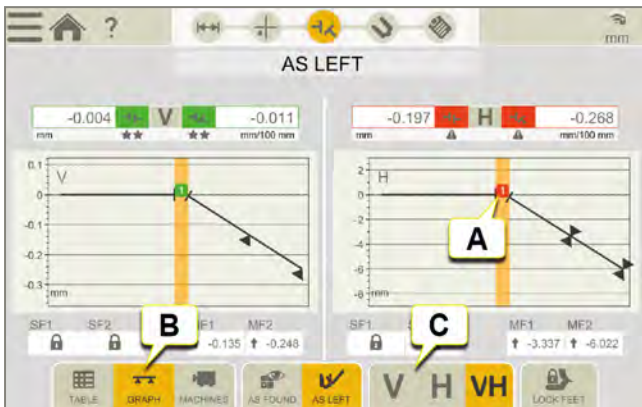

Graph view

Tap  to show the graph.



- A. Coupling number. color indicates tolerance. See "Tolerance" on page 80
- B. Tap to change result view.
- C. Tap to show only vertical or horizontal view.



	This coupling has been adjusted.
	Thermal compensation.
	Indicates not within tolerance.
	Within tolerance. 1-3 stars depending on which tolerance is used.

Result table

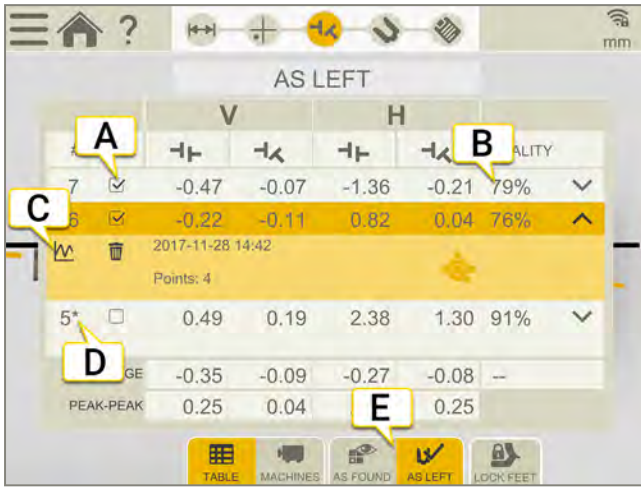
In the Result view, tap  to display the table view.



- A. Select to use the measurement in the calculations.
- B. Quality assessment for the measurement. Available if you have used the method Continuous Sweep or Multipoint.
- C. Open detailed view See "Result details" on the facing page
- D. This measurement has been adjusted.
- E. Toggle between showing As found or As left values.

If you want delete a measurement, tap  and .

Use

By default, all measurements are included in the calculations. If you deselect measurements, the values for Average and Peak to Peak are updated. The excluded measurements are not included in the calculations, but still visible. The report will not be affected if you hide any measurements, in the report it is always the latest measurements that are shown.

NOTE! It is always the latest measurement and adjustment that are shown in the report.

Average

The average offset and angle values. Calculations are based on the measurements marked as "Use".

Peak to peak

The total variation in offsets and angles. Calculations are based on the measurements marked as "Use".

Result details

When you have measured using Sweep or Multipoint, you can view details regarding the measurement.

Tap  to open the Detailed view. This information is available from the table on the Measurement view, or from the Result table.

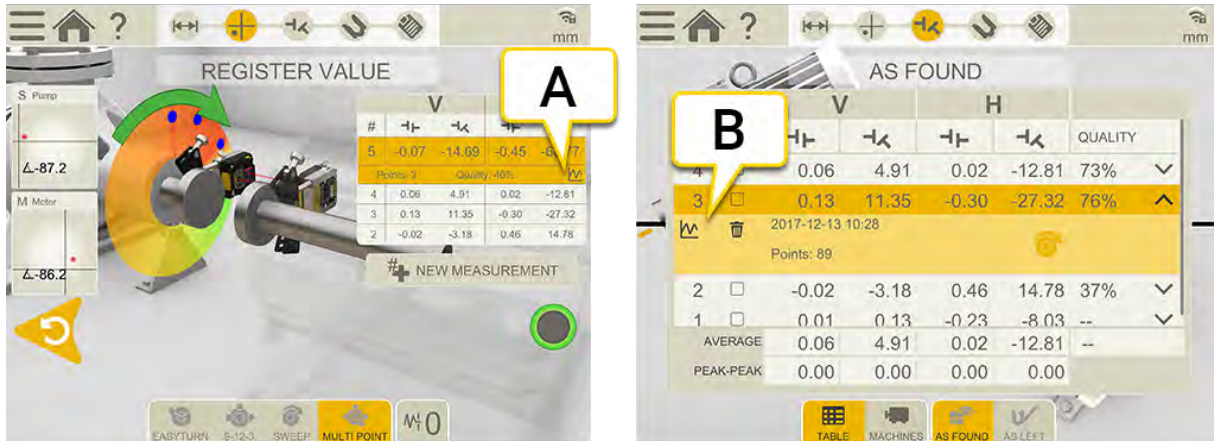

- A. Measurement view
- B. Result table

Sweep details

Measurement error



This graph shows the error of each measurement compared to the whole measurement. The standard deviation of the error is the basis for the quality number "Acquired accuracy". Turbulence, distance between the measuring units and coupling backlash all affect the measurement error.

Shown in mils or mm.

HORIZONTAL

Rotation speed



This graph shows how fast the measurement units are rotated during the measurement. This is the basis for the quality number "Speed and evenness".

Quality

The quality assessment is a sum of the following quality factors:

- **Rotation angle.** How much of the turn that is measured. For an accurate result, try to have as large rotation angle as possible.
- **Acquired accuracy.** Actual accuracy of the measured values from the units. If the acquired accuracy is low, it may depend on for example air turbulence or bearing clearance.
- **Temperature stability.** Measured temperature variation in the measuring units. If the stability is low, remeasure when the temperature has stabilized.
- **Speed and evenness.** Speed of the rotation.
- **Measurement direction.** Indicates the consistency in your measurement direction. It is better to move the measurement units in the same direction during the entire measurement. A low value indicates the direction has changed during measurement, which may hurt the measurement quality.

Multipoint details

Measurement error



This graph shows the error of each measurement compared to the whole measurement. The error of each measurement point is how much it deviate from the whole measurement. Shown in offset and angle.

Values

Multi Point Details						
Measurement Error		Values		Quality		
#	M-Angle	M-PsdY	S-Angle	S-PsdY	Offset Error	Angular Error
1	-3.7°	7.87	-4.5°	6.96	0.01	0.17
2	-30.8°	8.20	-31.0°	6.76	0.01	0.07
3	-68.5°	8.49	-70.4°	6.55	0.00	0.12
4	-108.5°	8.75	-108.9°	6.33	0.00	0.02
5	-135.4°	8.90	-135.7°	6.17	0.00	0.05
6	-158.5°	9.02	-158.1°	6.04	0.00	0.09
7	170.5°	9.14	170.4°	5.85	0.00	0.04
8	141.2°	9.22	139.4°	5.66	0.00	0.11

V		H	
←	-0.04	→	0.07
↙	-0.79	↘	-0.21

All registered values.

Quality

Multi Point Details	
Measure	Quality
Attainable Accuracy	94%
Acquired Accuracy	54%
Temperature stability	97%
Measurement direction	95%
Quality assessment	54%



V		H	
←	-0.04	→	0.07
↙	-0.79	↘	-0.21

The quality assessment is a sum of the following quality factors:

- **Attainable accuracy.** The maximum accuracy that can be attained. Many measurement points that also have a good spread, will statistically ensure a high accuracy.
- **Acquired accuracy.** Actual accuracy of the measured values from the units. If the acquired accuracy is low, it may depend on for example air turbulence or bearing clearance.
- **Temperature stability.** Measured temperature variation in the measuring units. If the stability is low, remeasure when the temperature has stabilized.
- **Measurement direction.** Indicates the consistency in your measurement direction. It is better to move the measurement units in the same direction during the entire measurement. A low value indicates the direction has changed during measurement, which may hurt the measurement quality.

ADJUST

In the Adjust view, live values are displayed. When reading the values, face the stationary machine from the movable machine. For information how to read the values, See "Result" on page 96. Values within tolerance are green.

1. Shim the machine according to the vertical feet values.
2. Adjust the machine sideways according to the live horizontal values.
3. Tighten the feet.
4. Tap  to remeasure or tap  to view the report.

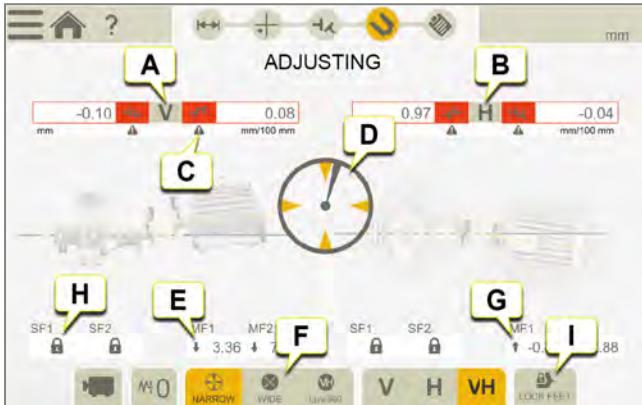

- A. Vertical offset and angle values.
- B. Horizontal offset and angle values.
- C. Tolerance indicators. See "Tolerance" on page 80.
- D. Turn to live.
- E. Arrow shows how to adjust the vertical values.
- F. Select narrow, wide or 360 live sectors.
- G. Arrow shows how to adjust the horizontal values.
- H. Indicates Locked feet.
- I. Lock feet. See "Locked feet" on page 81.

To simulate an adjustment, See "Adjustment Guide" on page 107

Graph view

Tap  to show the graph.

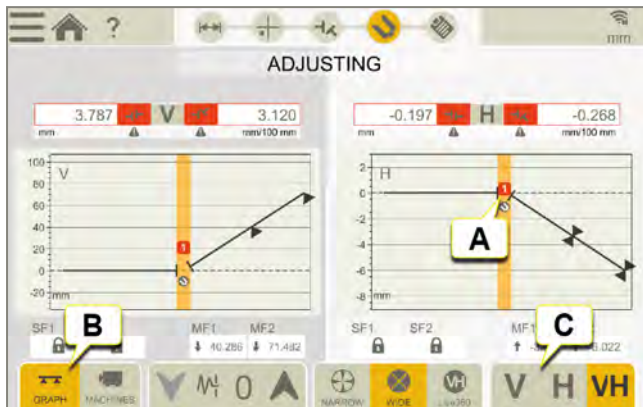

- A. Coupling number. color indicates tolerance. See "Tolerance" on page 80
- B. Tap to change result view.
- C. Tap to show only vertical or horizontal view.

Live values with inclinometer

With the programs EasyTurn, Sweep and Multipoint, the inclinometer controls when live values are shown.

Select one of the corresponding live options:

	Narrow, live values are shown when the units are positioned within ($\pm 2^\circ$) of the clock positions.
	Wide, live values are shown when the units are positioned within ($\pm 44^\circ$) of the clock positions.
	Live360, live values are shown in both vertical and horizontal direction. Only available when using XT70. When you select Live360, make sure that you have not moved the measuring units after registering the last measurement point. If you have, please remeasure to ensure an accurate result.

NOTE! The live option 360 is sensitive for movements/backlash. Ensure that backlash will not influence the measurement.

Live values without inclinometer

With the program 9-12-3 the inclinometer is not used, instead you manually show in which position your measurement units are.

1. Turn the shafts with detectors to a live position.
2. Tap the corresponding live option, see below.
3. Tap before you leave the live position.



Live options:

	Not live. If you want to change live position, you need to select this first and then the new position.
	Live at 9 o'clock.
	Live at 12 o'clock.
	Live at 3 o'clock.
	Live at 6 o'clock.

ADJUSTMENT GUIDE

Measuring units that can be used: XT50 and XT70.

In the Adjustment Guide, only simulated values are displayed. By using this feature you can simulate adjustments on the machine feet before doing the real adjustment. The Adjustment Guide is especially useful to investigate the effect on the alignment from adding shims of known thickness at the machine feet.

1. Tap  and . Only available when you have made a measurement.
2. Tap the foot you want to adjust.
3. Simulate an adjustment.
4. Tap  to return to the previous screen.

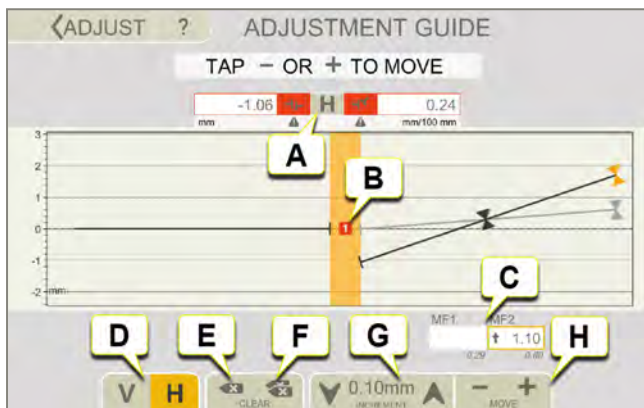



- A. Offset and angle values.
- B. Coupling number. Color indicates tolerance. See "Tolerance" on page 80
- C. Tap to select movement simulation. Then use arrows to change values (see G below).
- D. Tap to alternate between vertical (V) or horizontal (H) view.
- E. Tap to clear the selected value.
- F. Tap to clear all inserted values.
- G. Increment value. Tap the arrows to change the value of the increment.
- H. Tap to adjust the simulated vertical or horizontal values.

HORIZONTAL REPORT

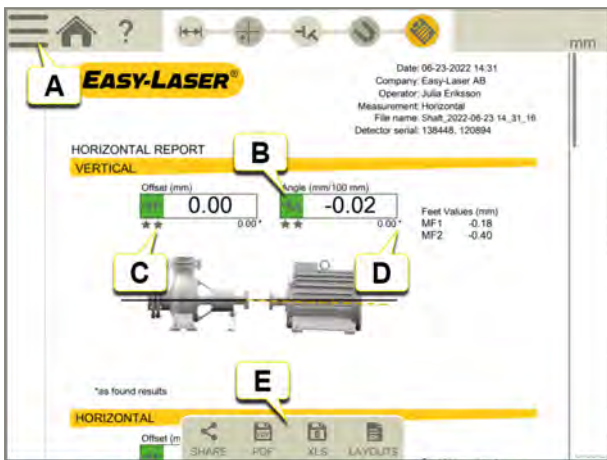
The report covers all details from the measurement. The report is constantly being filled out while the session is carried out. To see the report at its current state, tap  in the workflow.



- A. Tap  and  to finalize the measurement. See "Finalize" on page 8
- B. Green = within tolerance.
- C. In this example the angle result is shown as Gap.
- D. The "As found" result is marked with an asterisk (*).
- E. Save as a Pdf or Excel file. The files are saved in the File manager. The functions Share and Save as Pdf or Excel file are available after the measurement has been finalized.

For information on how to:

- Change the template
- Add a note
- Add a photo
- Change user information
- Save a report
- Share a report to USB

See " Report Overview" on page 14.

MACHINE TRAIN

OVERVIEW MACHINE TRAIN

Measuring two couplings or more

Build your own machine train with theoretically as many machines as you like. You can pick the reference machine manually, or let the program choose one that will minimize the need for adjustments.

Measuring units that can be used:

XT50, XT60 and XT70

The live option "Live360" is only available when using **XT70**.



Measuring two couplings

For alignment of machine trains with three machines. You can pick the reference machine manually, or let the program choose one that will minimize the need for adjustments.

Measuring units that can be used: XT60.

Workflow Machinetrain



The workflow on the top of the screen will guide you through your work. The current view is marked yellow. The report is constantly being filled out while the session is carried out. To see the report at its current state tap  in the workflow. The measurement is saved automatically through the entire workflow.

When you have finished the measurement, tap  and  to finalize it.



Prepare view is active in the workflow

Create a template

1. Tap  and .
2. Enter a new name or keep the default name. The template is saved in the File manager.

See "Templates for measurements" on page 12.

PREPARE

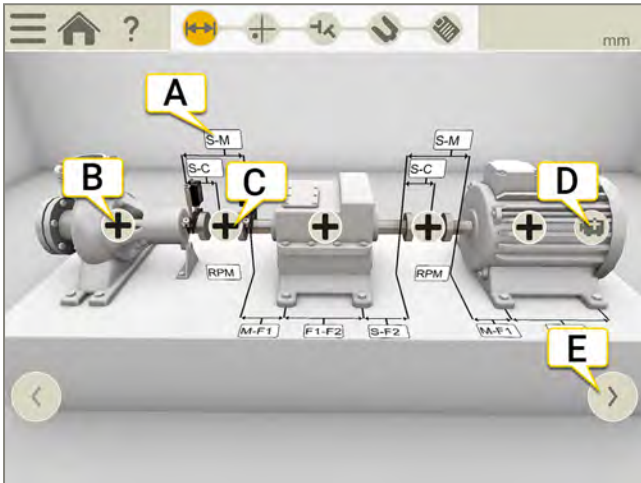

1. Set up and rough align the measuring units. XT50 and XT60 measuring units can be used.
2. Make sure that the measuring units are charged.
3. Set up and rough align the measuring units.
4. Enter distances.
5. Enter machine and coupling properties.
6. Tap  to continue to measure view.

It is possible to go back to the Prepare view later and enter/alter information.



- A. Tap any field to enter distances. See "Enter distances" on the facing page.
- B. Tap to display Machine setup. See "Configuration" on page 160.
- C. Tap to display Coupling setup. See "Coupling setup" on page 79.
- D. Tap to add a machine.
- E. Tap to display other part of the train (if the train is longer than three machines).

Add or remove a machine

- Tap  to add a machine. A generic machine is added at the end of the train.
- Tap  and  to remove a machine. It is only possible to remove the last machine of the train.

See also

See "RPM Horizontal" on page 79

See "Thermal compensation " on page 82

See "Tolerance" on page 80

Enter distances

Tap any distance input field to enter distance. The field is zoomed in and the keyboard is displayed.

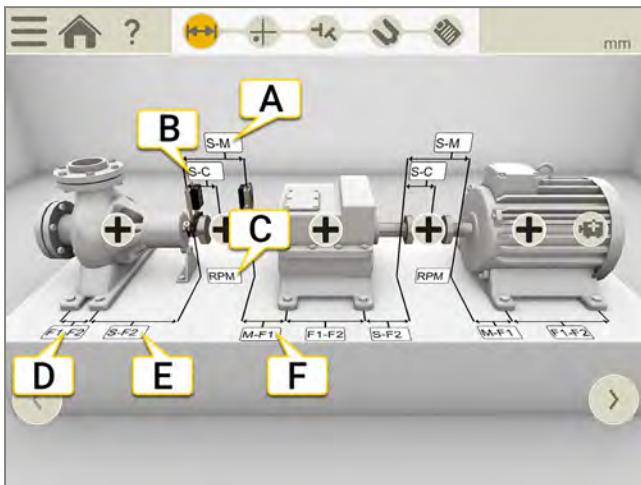

- A. Distance between S-unit and M-unit. Measure between the rods.
- B. Distance between S-unit and center of coupling.
- C. RPM. When you enter RPM, a corresponding tolerance is automatically selected.
- D. Distance between first and second foot. To enter distances on the S-machine, tap **+** and **↔** to display the fields.
- E. Distance between second foot and S-unit.
- F. Distance between M-unit and foot one. It is possible to enter a negative value here.

Required distances

It is possible to skip all distances and go directly to Measure view. If you change a distance later on, the result is recalculated.

- To calculate an offset and angle result, you need to enter at least the distances between S and M.
- Feet values can only be calculated if you have entered the distance between the feet.

Machine setup

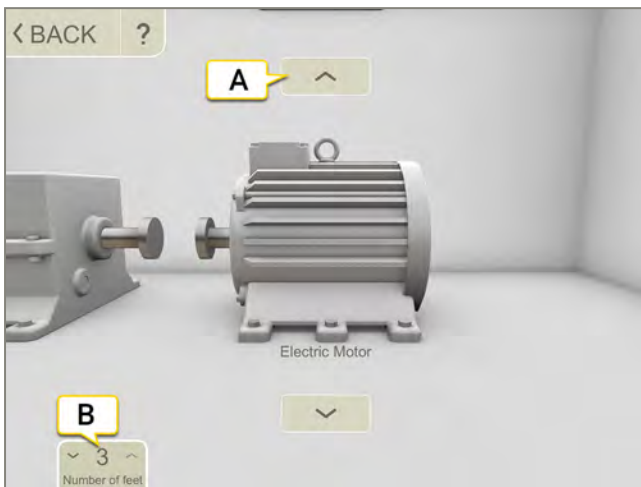

On the machine, tap  to open the Machine set-up view. It is possible to change the image and change the number of feet.



- A. Tap arrows change the machine image.
- B. Tap to change the number of feet. The possible number of feet varies depending on machine.

Name the machine

Use if you want to change the default names on the machines. The name is visible in the report.

1. Tap  on the machine.
2. Tap .
3. Tap the text input field to change the name.

Coupling setup

Coupling type



1. On the coupling, tap **+**.
2. Tap .
3. Select coupling type.

Coupling diameter

If you want the result based on the gap of the coupling instead of angle, it is necessary to enter the coupling diameter. The coupling diameter is visible in the report.

1. On the coupling, tap **+**.
2. Tap .
3. Enter the diameter.

Gap

To show the result as gap, tap  and .

Angle/Angle or Offset/Offset

In result view you can choose either Angle/Angle or Offset/Offset view.

To be able to do this you must first select Angle/Angle or Offset/Offset in the Prepare step.

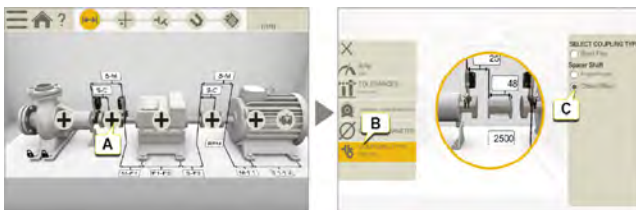

- A. Tap to open Coupling properties.
- B. Tap Coupling type.
- C. Tap Offset/Offset (or Angle/Angle).

RPM Machine Train

The rotation speed of the shafts will decide the demands on the alignment. When you select a rpm value, a matching tolerance is set automatically.

The higher the rpm of a machinery is, the tighter the tolerance must be.

1. Tap the RPM field to enter a value. Or tap **+** and  on the coupling.
2. Enter RPM. A tolerance is automatically set to match the RPM you entered.

Tolerance

The rotation speed of the shafts will decide the demands on the alignment. When you select a rpm value, a matching tolerance is set automatically.

The higher the rpm of a machinery is, the tighter the tolerance must be.

1. On the coupling, tap **+**.
2. Tap **ii** to display the tolerance menu.

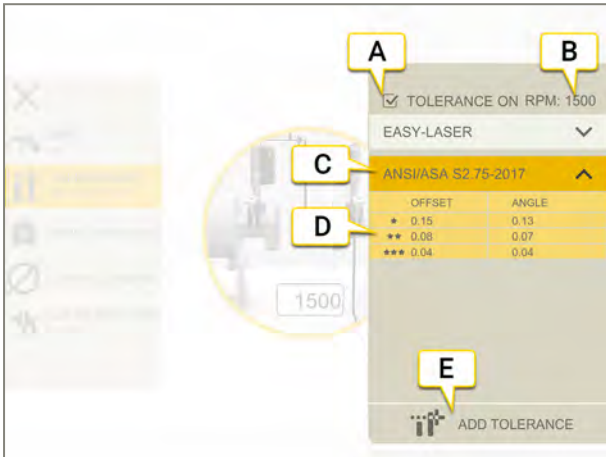

- A. Turn tolerance on/off.
- B. Current RPM.
- C. Selected tolerance.
- D. Tolerance levels.
- E. Add custom tolerance.

Built-in tolerances

The system comes with two built-in tolerances, *Easy-Laser Standard* and *ANSI standard*.

The system remembers which tolerance was last selected and will use that tolerance as the default selection when a new measurement session is created. When you set an RPM value, the tolerance is activated.

Easy-Laser

The tolerance level "good" is used for re-alignments on non-critical machinery. New installations and critical machines should always be aligned within the tolerance level "excellent".

There are two tolerance levels:

	Indicates not within tolerance. Red background.
	Good. Yellow background.
	Excellent. Green background.



ANSI standard

The ANSI/ASA S2.75-2017 standard is available. This standard has three tolerance levels:

	Indicates not within tolerance. Red background.
	Minimal. Orange background.
	Standard. Yellow background.
	Precision. Green background.

Custom tolerance

Many machines must be aligned very accurately even if they have a lower rpm. You can add your own user defined tolerance.

1. Tap .
2. Enter offset and angle values.
3. Tap  to add the custom tolerance.

There are two tolerance levels for custom tolerances.

Spacer shaft tolerance

If you have selected spacer shaft, no offset tolerance is used. Both angles (A and B) are compared and have to be within tolerance.

Thermal compensation



During normal operation, machinery is influenced of different factors and forces. The most common of these changes is the change in the temperature of the machine. This will cause the height of the shaft to increase. This is called thermal growth. To compensate for thermal growth, you enter values for cold condition compensation. It can be necessary to place the offline (cold) machine a bit lower to allow thermal growth.

To compensate for thermal growth, offset and angle values are used. The offset and angle values are based on a calculation point:

- For short flex, the calculation point is in the center of the coupling.
- For spacer shaft, the calculation point is on the left side of the spacer.

It is **not** possible to have both coupling and feet compensation on the same machine.

Set compensation on the coupling

1. Tap **+** on the coupling.
2. Tap  to open the Thermal Compensation view.
3. Enter values for Vertical and/or Horizontal compensation. When you enter compensation values, the machine turns blue.
4. Tap  to return to Prepare view.

The compensation values are visible in the report.

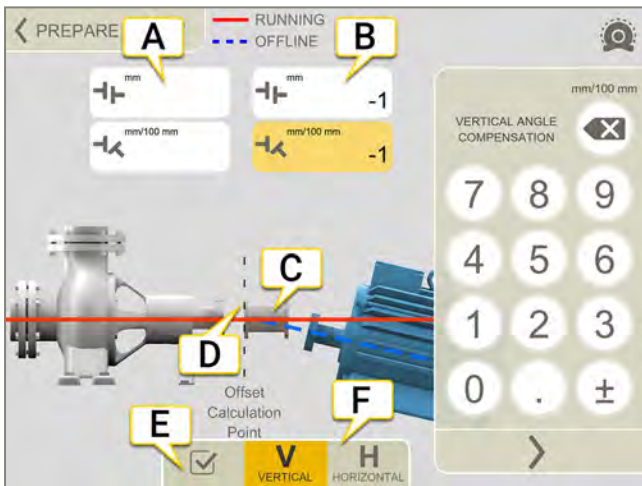



- A. Offset and angle values for the left machine.
- B. Offset and angle values for the right machine.
- C. Spacer shaft.
- D. Calculation point is on the left side of the spacer.
- E. Turn Thermal compensation on/off. If you turn it off, the values are saved but will not be used. In Machine train, this will affect **all** couplings in the train.
- F. Show V (vertical) or H (horizontal) view.

NOTE! It is **not** possible to have both coupling and feet compensation on the same machine.

Set compensation on feet

Values are entered on the first and last foot on the machine. If the machine has more than two feet, calculated values on these are presented in the report.

1. Enter distances.
2. Tap **+** on the machine.
3. Tap  to open the Thermal Compensation view.
4. Enter values for Vertical and/or Horizontal compensation. When you enter compensation values, the machine turns blue.
5. Tap  to return to Prepare view.

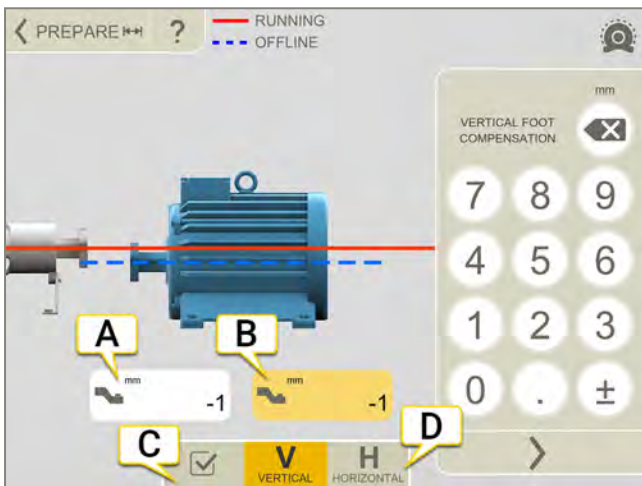

- A. Feet value for the first foot.
- B. Feet value for the last foot.
- C. Turn Thermal compensation on/off. If you turn it off, the values are saved but will not be used. In Machine train, this will affect **all** couplings in the train.
- D. Show V (vertical) or H (horizontal) view.

NOTE! It is **not** possible to have both coupling and feet compensation on the same machine.

Example without compensation

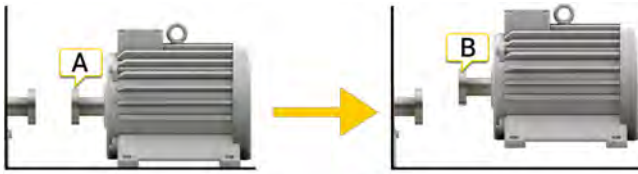

- A. Offline, no compensation set. The machines are aligned.
- B. Running, the machine "grows" 5 mm, and is no longer aligned.

Example with compensation

In this example we assume a thermal growth of +5 mm in HOT condition. Therefore we compensate with -5 mm in offline condition.

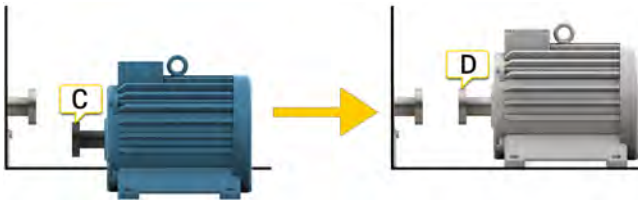

- C. Offline, a -5 mm compensation has been set.
- D. Running, the machine grows and will be perfectly aligned!

MEASURE USING EASYTURN™

With EasyTurn™, it is possible to measure with as little as 40° spread between the measurement points. However, for an even more accurate result, try to spread the points as much as possible.







Preparations

Before you start measuring, make sure you have done the preparations you need.

- Mount the measuring units.
- To calculate results, you need to enter at least the distance between the measuring units.
- Tap a target to connect measuring units. See "Select measuring units" on page 37.
- If needed, perform a rough alignment.
- If needed, measure Softfoot. See "Softfoot" on page 1

Measure

It is possible to switch measuring method before you have registered a value.

1. Tap  on the tab to select the method EasyTurn.
2. Adjust laser to the center of the targets. If needed, adjust the units on the rods, then use laser adjustments knobs.
3. Tap  to register the first position. A red marking is displayed.
4. Turn the shafts at least 20°.
5. Tap  to register the second position.
6. Turn the shafts at least 20°.
7. Tap  to register the third position.
8. Tap  to go to the Result view, or tap  to measure again.

The registered values are saved when you leave the Measure view. If you return to the Measure view, it is possible to do a new measurement.

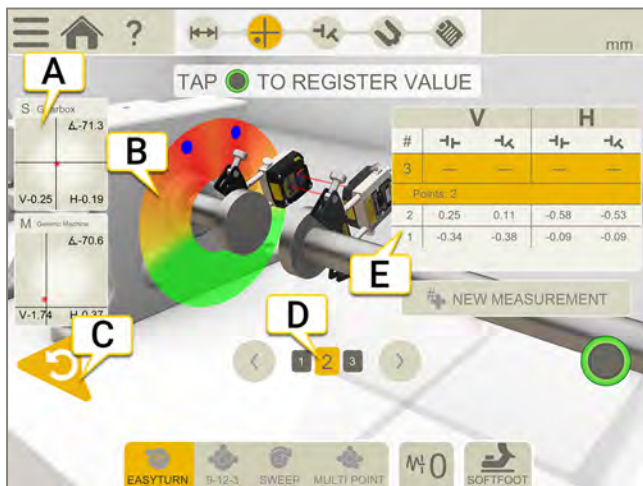

- A. Tap to display detector information.
- B. Red = turn shafts outside the red marking.
Green = turn shafts to green area.
Blue = registered position.
- C. Delete registered value.
- D. Active coupling is yellow. Tap the arrows to move to other couplings.
- E. Measurement table. If you have selected spacer shaft, see information below.

#+	Make a new measurement. This makes it possible to check the repeatability of the measurement.
	Measure using EasyTurn™.
	Measure using 9-12-3.
	Measure using Multipoint.
	Measure using Continuous sweep.
	Set Filter value.
	Measure Softfoot.

Spacer shaft in measurement table



- A. Vertical values for angle A and B
- B. Horizontal values for angle A and B

Edge warning

When the laser beam is close to the edge, the edge is “lit up” as a warning. It is still possible to register values when the edge warning is active.

Zero inclinometer

If the machine is mounted on an inclined base plane, you can manually set the inclinometer to a new 12 o'clock position. The following measurements will then use the new inclinometer settings.

1. Choose the measuring method you want to use.
2. Turn the measuring units so that the rods are perpendicular to the base plane.
3. Tap and .
4. Confirm the desired position for the measuring units by tapping . The inclinometer will now be set to zero.

Your inclinometer adjustment will be applied during the whole measurement session, but will be restored when you start a new measurement from the start menu.

Explanation regarding measurement table for all machine train measuring methods

!	Uncertain coupling. When you adjust one coupling, it might affect the next coupling in the machine train. This coupling needs to be remeasured.
*	The coupling has been adjusted. This is not a value from your original measuring.

MEASURE USING 9-12-3

The measuring positions are registered at positions 9, 12, 3 o'clock. The inclinometers are not used.







Preparations

Before you start measuring, make sure you have done the preparations you need.

- Mount the measuring units.
- To calculate results, you need to enter at least the distance between the measuring units.
- Tap a target to connect measuring units. See "Select measuring units" on page 37
- If needed, perform a rough alignment.
- If needed, measure Softfoot, See "Softfoot" on page 1.

Measure

It is possible to switch measuring method before you have registered a value.

1. Tap  on the tab to select the method 9-12-3.
2. Adjust laser to the center of the targets. If needed, adjust the units on the rods, then use laser adjustments knobs.
3. Turn shafts to 9 o'clock.
4. Tap  to register the first position.
5. Turn shafts to 12 o'clock.
6. Tap  to register the second position.
7. Turn shafts to 3 o'clock.
8. Tap  to register the third position.
9. Tap  to go to the Result view, or tap  to measure again.

The registered values are saved when you leave the Measure view. If you return to the Measure view, it is possible to do a new measurement.

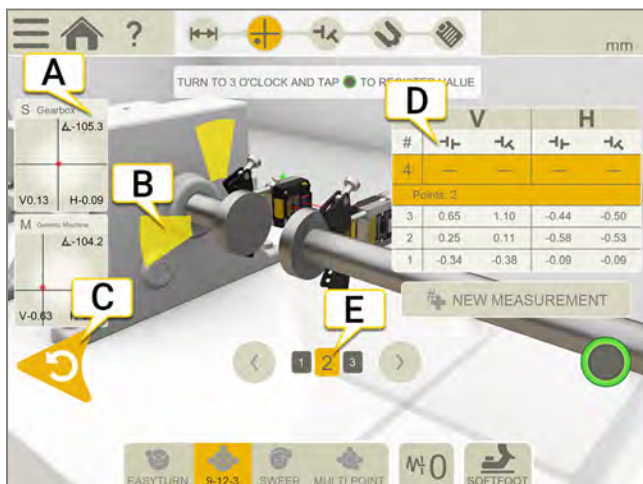

- A. Tap to display detector information.
- B. Yellow = registered position.
Green = turn shafts to green area.
- C. Delete registered value.
- D. Measurement table.
- E. Active coupling is yellow. Tap arrows to move to other couplings.

MACHINE TRAIN

#+	Make a new measurement. This makes it possible to check the repeatability of the measurement.
	Measure using EasyTurn™.
	Measure using 9-12-3.
	Measure using Multipoint.
	Measure using Continuous sweep.
	Set Filter value.
	Measure Softfoot.

Spacer shaft in measurement table



- A. Vertical values for angle A and B
- B. Horizontal values for angle A and B

Edge warning

When the laser beam is close to the edge, the edge is “lit up” as a warning. It is still possible to register values when the edge warning is active.

MEASURE USING MULTIPOINT

Preparations





Before you start measuring, make sure you have done the preparations you need.

- Mount the measuring units. "Multipoint" is available when you use XT60 measuring units.
- To calculate results, you need to enter at least the distance between the measuring units.
- Tap a target to connect measuring units. See "Select measuring units" on page 37
- If needed, perform a rough alignment.
- If needed, measure Softfoot. See "Softfoot" on page 1.

Measure

It is possible to switch measuring method before you have registered a value.



For a more accurate result, try to spread the points as much as possible. The colors indicates where the optimum positions to measure are. Green is best place to measure. Always turn the shaft in the same direction for a more accurate result.



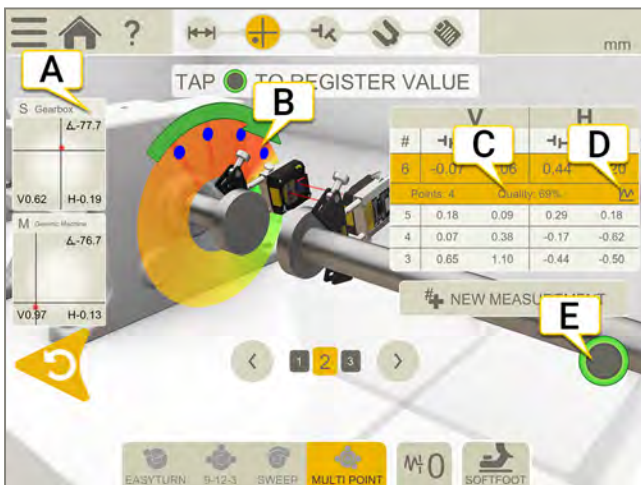

1. Tap  on the tab to select the method Multipoint.
2. Adjust laser to the center of the targets. If needed, adjust the units on the rods, then use laser adjustments knobs.
3. Tap  to register the first position. The first position is automatically set to zero.
4. Tap  to register as many positions as you wish. After three points a result is available.
5. Tap  to go to the Result view, or tap  to measure again.

The registered values are saved when you leave the Measure view. If you return to the Measure view, it is possible to do a new measurement.



- A. Tap to display detector information.
- B. Registered measurement point.
- C. Quality assessment.
- D. Tap  to show detailed information. See "Result details" on page 101.
- E. Tap to register values.

	Make a new measurement. This makes it possible to check the repeatability of the measurement.
	Measure using EasyTurn™.
	Measure using 9-12-3.

	Measure using Multipoint.
	Measure using Continuous sweep.
	Set Filter value.
	Measure Softfoot.

Spacer shaft in measurement table





- A. Vertical values for angle A and B
- B. Horizontal values for angle A and B

Edge warning

When the laser beam is close to the edge, the edge is “lit up” as a warning. It is still possible to register values when the edge warning is active.

Zero inclinometer

If the machine is mounted on an inclined base plane, you can manually set the inclinometer to a new 12 o'clock position. The following measurements will then use the new inclinometer settings.

1. Choose the measuring method you want to use.
2. Turn the measuring units so that the rods are perpendicular to the base plane.
3. Tap  and .
4. Confirm the desired position for the measuring units by tapping . The inclinometer will now be set to zero.

Your inclinometer adjustment will be applied during the whole measurement session, but will be restored when you start a new measurement from the start menu.

MEASURE USING CONTINUOUS SWEEP

Automatic recording of measurement values during continuous sweeping of the shaft.

There is no limit on the number of points.





Preparations

Before you start measuring, make sure you have done the preparations you need.

- Mount the measuring units. "Continuous sweep" is available when you use XT60 measuring units.
- To calculate results, you need to enter at least the distance between the measuring units, see "Enter distances" on page 77.
- Tap a target to connect measuring units. See "Select measuring units" on page 37.
- If needed, perform a rough alignment.
- If needed, measure Softfoot. See "Softfoot" on page 1.

Measure

It is possible to switch measuring method before you have registered a value. Filter is **not** available when you measure with Sweep.

1. Tap  on the tab to select the method Continuous sweep.
2. Adjust laser to the center of the targets. If needed, adjust the units on the rods, then use laser adjustments knobs.
3. Tap  to start the measurement.
4. Turn the shafts. Turn the shafts as much as possible for a more accurate result.
5. Tap  to stop the measurement.
6. Tap  to go to the Result view, or tap  to measure again.

The registered values are saved when you leave the Measure view. If you return to the Measure view, it is possible to do a new measurement.

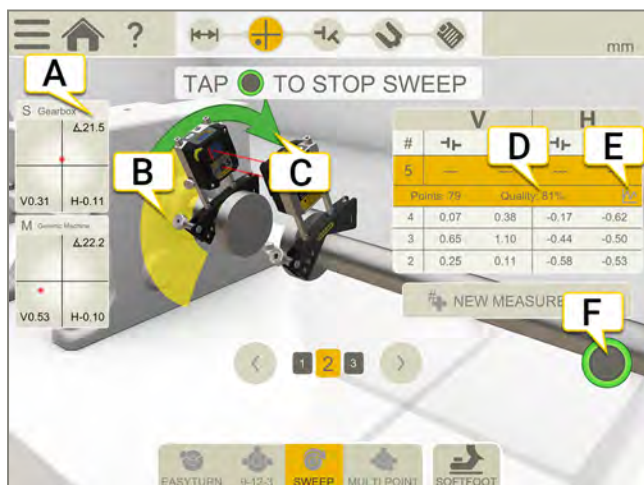

- A. Tap to display detector information.
- B. Yellow area is where points have been registered.
- C. Measurement direction. If you change direction during the measurement, the arrow turns red.
- D. Quality assessment.
- E. Tap  to show detailed information. See "Result details" on page 101.
- F. Tap to start and stop the measurement.

	Make a new measurement. This makes it possible to check the repeatability of the measurement.
	Measure using EasyTurn™.
	Measure using 9-12-3.
	Measure using Multipoint.
	Measure using Continuous sweep.
	Measure Softfoot.

Spacer shaft in measurement table



- A. Vertical values for angle A and B
- B. Horizontal values for angle A and B

Edge warning

When the laser beam is close to the edge, the edge is “lit up” as a warning. It is still possible to register values when the edge warning is active.

Zero inclinometer

If the machine is mounted on an inclined base plane, you can manually set the inclinometer to a new 12 o'clock position. The following measurements will then use the new inclinometer settings.

1. Choose the measuring method you want to use.
2. Turn the measuring units so that the rods are perpendicular to the base plane.
3. Tap and .
4. Confirm the desired position for the measuring units by tapping . The inclinometer will now be set to zero.

Your inclinometer adjustment will be applied during the whole measurement session, but will be restored when you start a new measurement from the start menu.

MEASURE USING UNCOUPLED SWEEP

Measuring units that can be used: XT50, XT60 and XT70.

Purpose: Recording of measurement values on shafts that are so heavy or hard to rotate that slings or auxiliary slow turning motor may be required to perform rotation.





Preparations

Before you start measuring, make sure you have done the preparations you need.

- Mount the measurement units on the disconnected couplings or directly on the shafts.
- To calculate results, you need to enter at least the distance between the measuring units. See "Enter distances" on page 77
- Tap a target to connect measuring units. See "Select measuring units" on page 37
- If needed, perform a rough alignment.

Measure

It is possible to switch measuring method before you have registered a value. Filter is **not** available when you measure with Uncoupled Sweep.

1. Tap  on the tab to select the method Uncoupled sweep.
2. Adjust laser to the center of the targets. If needed, adjust the measurement units on the rods, then use laser adjustments knobs.
3. Tap  to start the measurement. A first measurement point will be recorded at this position.
4. Rotate one of the shafts to the desired position and then slowly rotate the opposite shaft to pass the position of the first measurement unit. A measurement point will automatically be recorded at this position.
5. Rotate the shafts, one after another, to different positions, preferably until a full revolution is completed.
6. Every sweep gives one measurement point.
7. At least three measurement points are required, but you can register as many as you wish.
8. Tap  to stop the measurement.
9. Tap  to go to the Result view, or tap  to measure again.

The registered values are saved when you leave the Measure view. If you return to the Measure view, it is possible to do a new measurement.

If you have registered less than three values and end the program (e.g. by exiting the app or selecting Main menu) or leave the Measure view during ongoing measuring, you will lose your registered values.

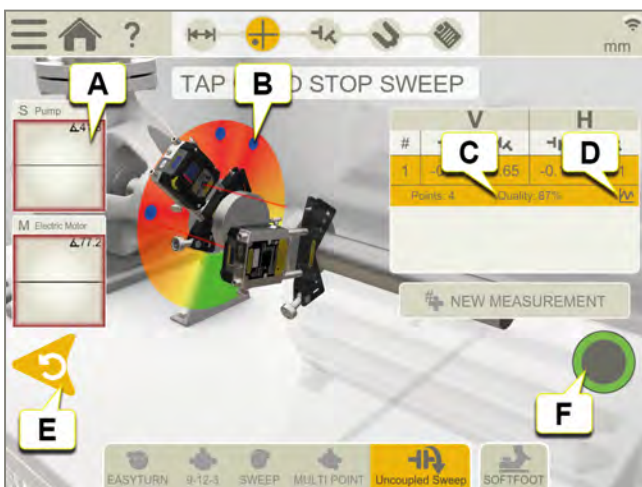







MACHINE TRAIN

- A. Tap to display detector information.
- B. Registered measurement point.
- C. Quality assessment.
- D. Tap  to show detailed information. See "Result details" on page 101.
- E. Delete registered value.
- F. Tap to start and stop the measurement.

NOTE! If sweeping rotation is too fast to register a value, the software will request that you slow it down.

NOTE! Sweeping rotation must be extra slow if you are running the XT app on Ecom Tab-EX 1 due to lower performance on this unit.



	Make a new measurement. This makes it possible to check the repeatability of the measurement.
	Measure using EasyTurn™.
	Measure using 9-12-3.
	Measure using Multipoint.
	Measure using Continuous sweep.
	Measure using Uncoupled sweep.
	Measure Softfoot.

Edge warning

When the laser beam is close to the edge, the edge is "lit up" as a warning. It is still possible to register values when the edge warning is active.

Zero inclinometer

If the machine is mounted on an inclined base plane, you can manually set the inclinometer to a new 12 o'clock position. The following measurements will then use the new inclinometer settings.

1. Choose the measuring method you want to use.
2. Turn the measuring units so that the rods are perpendicular to the base plane.
3. Tap  and .
4. Confirm the desired position for the measuring units by tapping . The inclinometer will now be set to zero.

Your inclinometer adjustment will be applied during the whole measurement session, but will be restored when you start a new measurement from the start menu.

MANUAL ENTRY

Manual entry is used to combine the current Machine Train measuring method with the possibility to manually add external measurement values for certain couplings. The benefit of this is that you are able to use many different measuring units to collect all your measurement values in the XT app and into the final report. See "Machine train Report" on page 141



- A. Selected coupling for Manual entry.
- B. Tap  to select Manual entry.
- C. Enter your Vertical and Horizontal measurement values.
- D. Icon showing coupling angle or offset according to entered measurement values.
- E. Tap to cancel entered measurement values.
- F. Tap when all measurement values are OK.

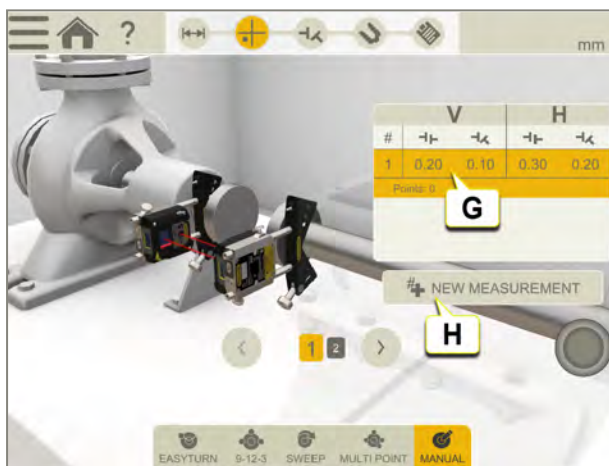

- G. When tapping "OK", your entered values are displayed in the measurement table.
- H. Tap to enter new measurement values.

After performing Manual entry you can select another coupling and measure with Easy-Laser measuring units.

NOTE! "Please observe the sign convention!" is referring to how the coupling icons show positive or negative offset or angle values in the XT app.

NOTE! Adjusting is not possible in Manual entry mode. To live adjust you need to use Easy-Laser measuring units connected to the XT app.





SOFTFOOT

Perform a softfoot check to ensure that the machine is resting evenly on all its feet. A softfoot can be angular and/or parallel. Softfoot can be caused by:

- Twisted machinery foundations.
- Twisted or damaged machinery feet.
- Improper amount of shims under machine feet.
- Dirt or other unwanted materials under machine feet.

Measure

Softfoot can be checked on all machines on which you have entered distances.

1. Enter distances between the measuring units and the feet. This is done on the Prepare view.
2. On the Measure view, tap  on the tab.
3. Place the detectors at 12 o'clock and rough align if needed.
4. Tap  in the workflow.
5. Tap any of the feet value boxes.
6. Loosen bolt and wait for movement. Check the graph to see when the value has stabilized.
7. Tighten the bolt and wait for the value to stabilize again.
8. Tap  to register value.
9. Tap another foot to measure. Tap  to show the Softfoot result.
10. Tap  to return to the Measure view.

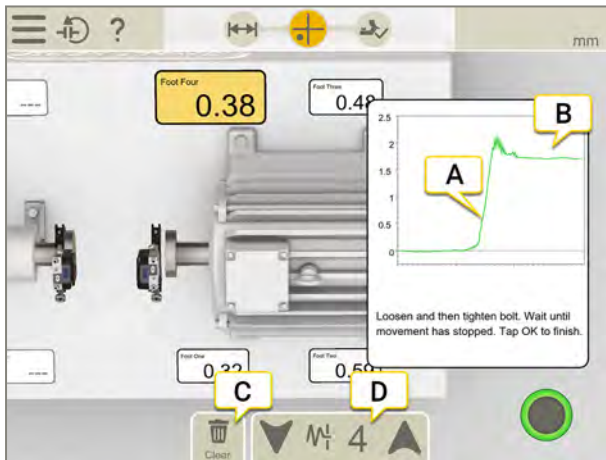

- A. Loosen bolt and wait for movement.
- B. Movement has stabilized. Tighten the bolt.
- C. Tap if you want to clear all softfoot values.
- D. Filter.

Filter

If you have a low filter, the detector filter is increased to filter 4 when you measure Softfoot. If you increase the filter setting while measuring Softfoot, the new filter will be default next time you start Softfoot.

Add a note





To add a note for the Softfoot measurement, tap .

For information on how to add a note, See " Report Overview" on page 14

RESULT

On the Result view, the offset, angle and feet values are clearly displayed. You can toggle between showing horizontal or vertical values. You can go back and forth between the views Measure, Result and Adjust.

Tap  if you want to adjust the machine. After you have adjusted, it is possible to go back to the Result view. There are four different result views:





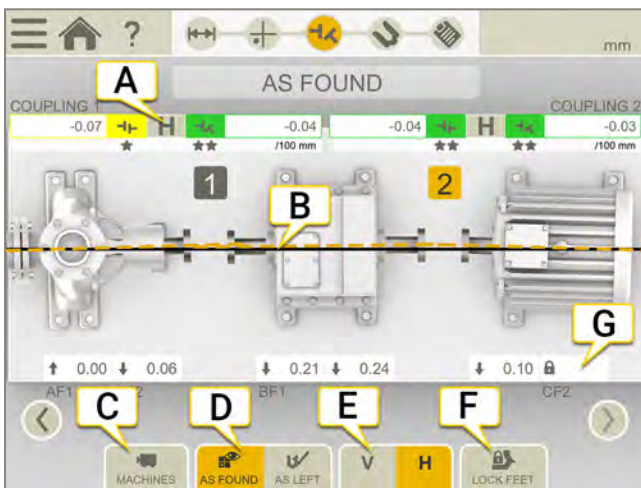

	Machine view.
	Graph view. See "Graph view" on page 134
	Train table. See "Train table" on page 135
	Coupling table. See "Coupling table" on page 136

Machine view

Tap  to view the machine view.



- A. Offset and angle values.
- B. Reference line.
- C. Tap to change result view.
- D. Show "As found" or "As left" values.
- E. Show the vertical or horizontal result.
- F. Lock feet.
- G. Feet values. If you have locked a foot, this is visualized with a lock .

	Coupling number.
	This coupling has been adjusted.
	Uncertain coupling. When you adjust one coupling, it might affect the next coupling in the machine train. This coupling needs to be remeasured.
	Thermal compensation.
	Indicates not within tolerance.
	Within tolerance. 1-3 stars depending on which tolerance is used.

How to read the values

When reading the values, face the stationary machine (S) from the movable machine (M). Then 9 o'clock is to the left, as in the measuring programs.

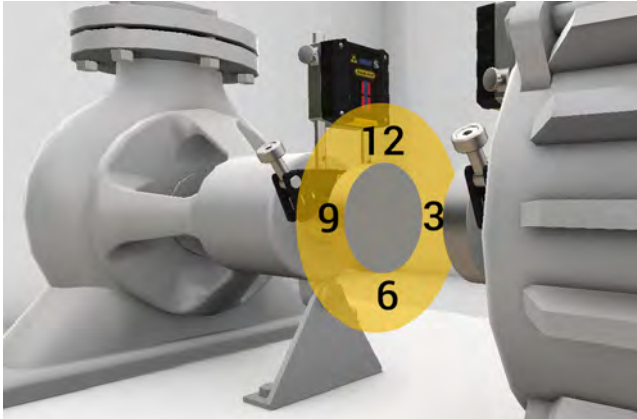

As found or As left

On the tabs, it is possible to toggle between showing As found or As left values.

	As found is the latest measurement you made before making an adjustment.
	As left is the latest adjusted result. Available if you have gone to the Adjust view (and shown live values) and returned to Result view.

Show Gap

By default, angular error/100 mm is displayed. To show gap, you need to set the coupling diameter.

To show the result as gap, tap and .

NOTE! For some machine configurations the 3D result may not be accurate. It is intended as a guide and may not always show the right rotation and position of the machine. The displayed values for feet and coupling errors are always accurate and should be followed in the event that the 3D result indicates otherwise.

Offset and angle values

The offset and angle value indicate how well the machine is aligned at the coupling. They appear in both horizontal and vertical direction. These values are important to get within tolerance.

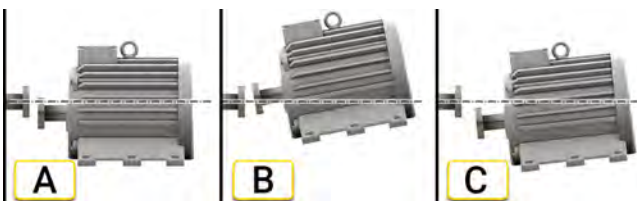

- A. Offset. The center lines of two axis are not concentric but parallel. This is measured at the coupling centers. In this example, a negative offset is shown.
- B. Angular misalignment. The center lines of two axis are not parallel. In this example, a positive angle is shown.
- C. Offset and angular misalignment. Misalignment is often a combination of both offset and angular misalignment.

Spacer shaft result

If you have selected spacer shaft, values for angle A and B are displayed. They appear in both horizontal and vertical direction.

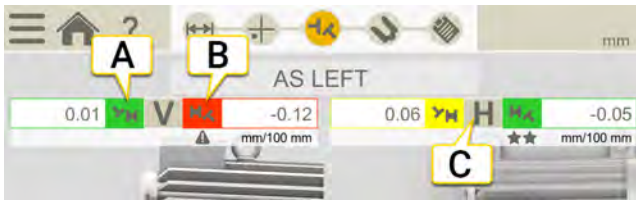

- A. Vertical values for angle A.
- B. Vertical values for angle B.
- C. Horizontal values.

Angle A and angle B

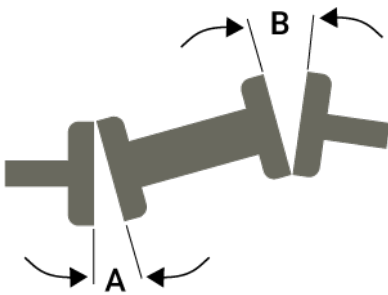

Spacer shaft result Offset/Offset

If you have selected spacer shaft Offset/Offset, values for offset A and offset B are displayed. They appear in both horizontal and vertical direction.

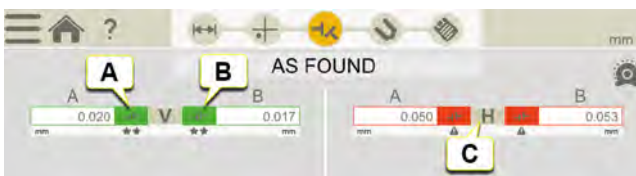

- A. Vertical values for Offset A.
- B. Vertical values for Offset B.
- C. Horizontal values.

Offset A and Offset B

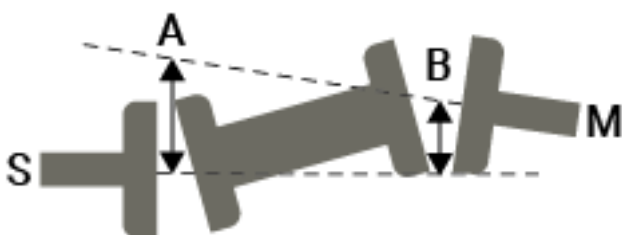

Graph view

Tap to show the graph.

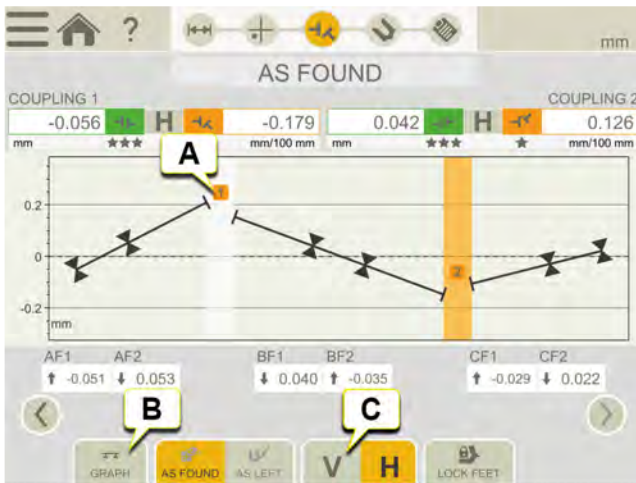

- A. Coupling number. color indicates tolerance. See "Tolerance" on page 114
- B. Tap to change result view.
- C. Tap to show vertical or horizontal.





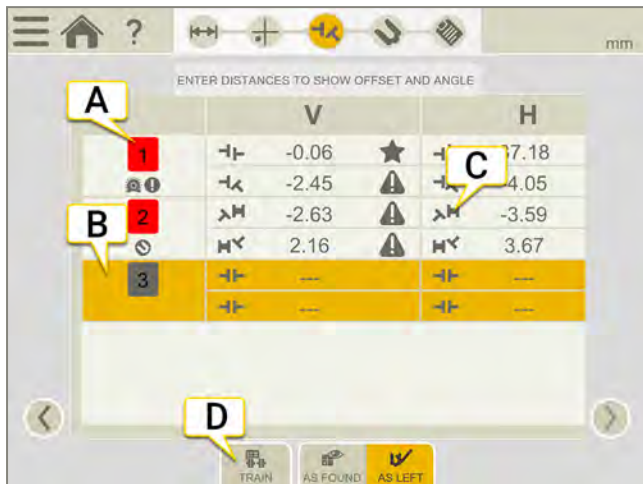

	Coupling number.
	This coupling has been adjusted.
	Uncertain coupling. When you adjust one coupling, it might affect the next coupling in the machine train. This coupling needs to be remeasured.
	Thermal compensation.
	Indicates not within tolerance.
	Within tolerance. 1-3 stars depending on which tolerance is used.
	Check that all couplings are measured and that all distances are entered.

Train table

Tap  to show the train table.



- A. Coupling number. Green = within tolerance, red = not within tolerance
- B. Selected coupling.
- C. Spacer shaft.
- D. Tap to change result view.



	Coupling number.
	This coupling has been adjusted.
	Uncertain coupling. When you adjust one coupling, it might affect the next coupling in the machine train. This coupling needs to be remeasured.
	Thermal compensation.
	Indicates not within tolerance.
	Within tolerance. 1-3 stars depending on which tolerance is used.

Coupling table

Tap  to view the coupling table. Shows the full result for one coupling at a time.



- A. Current coupling. Full result is shown for this coupling.
- B. Tap  to open the Detailed view. See "Result details" on page 101.
- C. Tap to change result view.
- D. Quality assessment for the measurement. Available if you have used the method Continuous Sweep or Multipoint.
- E. Tap to show another coupling.

If you want delete a measurement, tap  and .

!	Uncertain coupling. When you adjust one coupling, it might affect the next coupling in the machine train. This coupling needs to be remeasured.
*	The coupling has been adjusted. This is not a value from your original measuring.

Use

By default, all measurements are included in the calculations. If you deselect measurements, the values for Average and Peak to Peak are updated. The excluded measurements are not included in the calculations, but still visible. The report will not be affected if you hide any measurements, in the report it is always the latest measurements that are shown.

NOTE! It is always the latest measurement and adjustment that are shown in the report.

Average

The average offset and angle values. Calculations are based on the measurements marked as "Use".



Peak to peak

The total variation in offsets and angles. Calculations are based on the measurements marked as "Use".

Locked feet

Locked feet is available in the result view, both from Machine and Graph view.

This function is useful in cases when a foot is difficult or impossible to adjust. The Lock feet function allows you to select which feet that are locked and which that are adjustable. To display feet values on a machine with locked feet, you need to enter the distances.

1. Tap  on the tab in the result view.
2. Tap one or two fields to lock the corresponding feet. If you want to move a lock, simply tap it to unlock and then tap in another field.
3. Tap  when you are done.

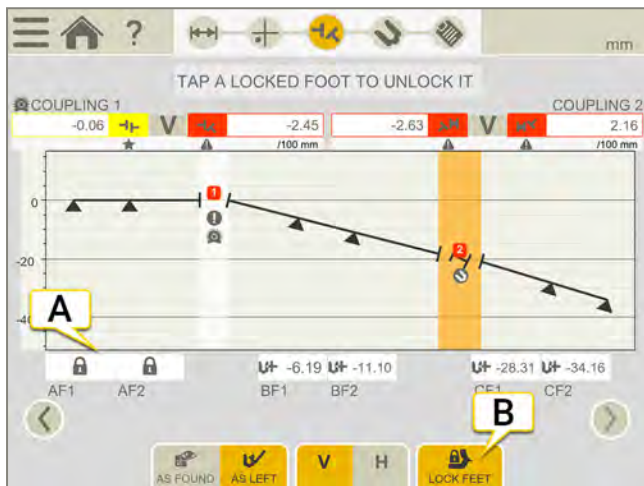





- A. Tap lock to unlock.
- B. Tap to finish.

NOTE! To display feet values on a machine with locked feet, you need to enter the distances.

ADJUST MACHINE TRAIN

In the Adjust view, live values are displayed.

1. Tap  in the workflow. The two machines where the measuring units are mounted will be zoomed in.
2. Tap  on the machine that you want to adjust.
3. Shim the machine according to the vertical feet values.
4. Adjust the machine sideways according to the live horizontal values.
5. Tighten the feet.
6. Tap  to remeasure or tap  to view the report.

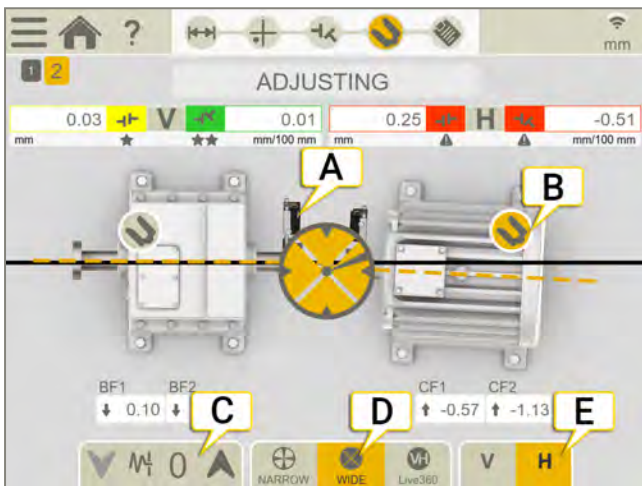



- A. The measuring units are placed on the coupling that was measured last.
- B. This machine is being adjusted.
- C. See "Filter" on page 8
- D. Select how to display the live values.
- E. Display vertical or horizontal view.

To simulate an adjustment, See "Adjustment Guide" on page 107

Adjust any coupling

After evaluation of the result, you can select which coupling in the machine train to adjust:



- A. In the Result view, use arrows  to select the coupling you want to adjust. Tap Adjust  in the workflow.
- B. Check that correct coupling is selected. Check distances, enter new distances if they are not correct. Tap OK.



C. Select machine to adjust by tapping  icon.

Remeasure the whole machine train after adjustment.



Tap Result  in the workflow and check that the values are correct.

NOTE! You can use the Adjustment guide for Machine train. By using this feature you can simulate adjustments on the machine feet before doing the real adjustment. See "Adjustment Guide" on page 107

Live values with inclinometer

With the programs EasyTurn, Sweep and Multipoint, the inclinometer controls when live values are shown.

Select one of the corresponding live options:

	Narrow, live values are shown when the units are positioned within ($\pm 2^\circ$) of the clock positions.
	Wide, live values are shown when the units are positioned within ($\pm 44^\circ$) of the clock positions.
	Live360, live values are shown in both vertical and horizontal direction. Only available when using XT70. When you select Live360, make sure that you have not moved the measuring units after registering the last measurement point. If you have, please remeasure to ensure an accurate result.





NOTE! The live option 360 is sensitive for movements/backlash. Ensure that backlash will not influence the measurement.

Live values without inclinometer

With the program 9-12-3 the inclinometer is not used, instead you manually show in which position your measurement units are.

1. Turn the shafts with detectors to a live position.
2. Tap the corresponding live option, see below.
3. Tap  before you leave the live position.



Live options:

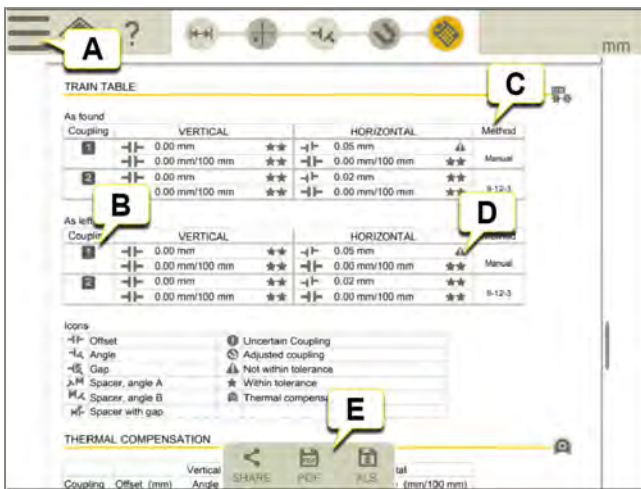

	Not live. If you want to change live position, you need to select this first and then the new position.
	Live at 9 o'clock.
	Live at 12 o'clock.
	Live at 3 o'clock.
	Live at 6 o'clock.

MACHINE TRAIN REPORT

The report covers all details from the measurement. The report is constantly being filled out while the session is carried out. To see the report at its current state, tap  in the workflow.



- Tap  and  to finalize the measurement. See "Finalize" on page 8
- Coupling number.
- Measuring method.
- Tolerance indicators.
- Save as a Pdf or Excel file. The files are saved in the File manager. The functions Share and Save as Pdf or Excel file are available after the measurement has been finalized.

	This coupling has been adjusted.
	Uncertain coupling. When you adjust one coupling, it might affect the next coupling in the machine train. This coupling needs to be remeasured.
	Thermal compensation.

For information on how to:

- Add a note
- Add a photo
- Change user information
- Save a report
- Share a report to USB

See " Report Overview" on page 14.

VERTICAL



OVERVIEW VERTICAL

For measurement and alignment of vertically and flange mounted machines.

Measuring units that can be used: XT40, XT50, XT60, XT70.

Workflow Vertical



The workflow on the top of the screen will guide you through your work. The current view is marked yellow. The report is constantly being filled out while the session is carried out. To see the report at its current state tap  in the workflow. The measurement is saved automatically through the entire workflow.

When you have finished the measurement, tap  and  to finalize it.



Prepare view is active in the workflow

Create a template

1. Tap  and .
2. Enter a new name or keep the default name. The template is saved in the File manager.

See "Templates for measurements" on page 12.

PREPARE

First you need to set up and rough align the measuring units:

- See "Set up XT40" on page 41
- See "Set up XT60" on page 47

On the Prepare view, you enter machine and coupling properties. It is possible to go back to the Prepare view later and enter/alter information. Tap **+** to display a property menu for the Coupling or Machine.

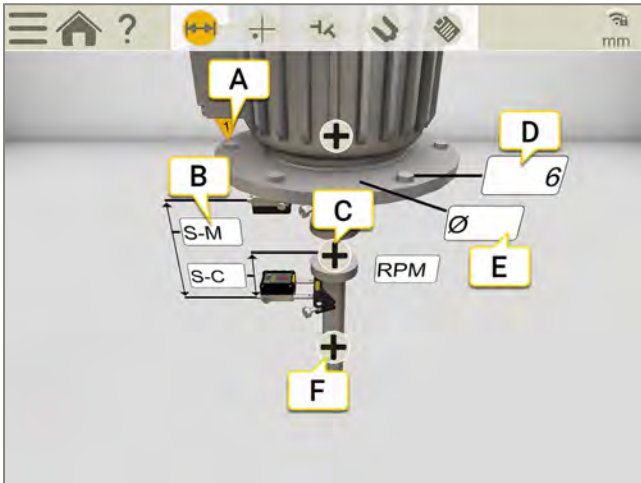



- The first bolt. Placed at 9 o'clock.
- Tap field to enter distance.
- Tap to open coupling properties. (RPM, tolerance and coupling diameter.)
- Number of bolts, default is set to 6. Four, six, eight and ten are possible values.
- Tap to enter the diameter formed by the circle of bolts.
- Tap to enter machine name.

NOTE! Make sure that the measuring units are changed.



Coupling setup

Coupling diameter

If you want the result based on the gap of the coupling instead of angle, it is necessary to enter the coupling diameter. The coupling diameter is visible in the report.

1. On the coupling, tap .
2. Tap .
3. Enter the diameter.



Gap

To show the result as gap, tap  and .

RPM Vertical

The rotation speed of the shafts will decide the demands on the alignment. When you select a rpm value, a matching tolerance is set automatically.

The higher the rpm of a machinery is, the tighter the tolerance must be.

1. Tap the RPM field to enter a value. Or tap  and  on the coupling.
2. Enter RPM. A tolerance is automatically set to match the RPM you entered.

See "Tolerance" on the next page

Tolerance

The rotation speed of the shafts will decide the demands on the alignment. When you select a rpm value, a matching tolerance is set automatically.

The higher the rpm of a machinery is, the tighter the tolerance must be.

1. On the coupling, tap **+**.
2. Tap **ii** to display the tolerance menu.

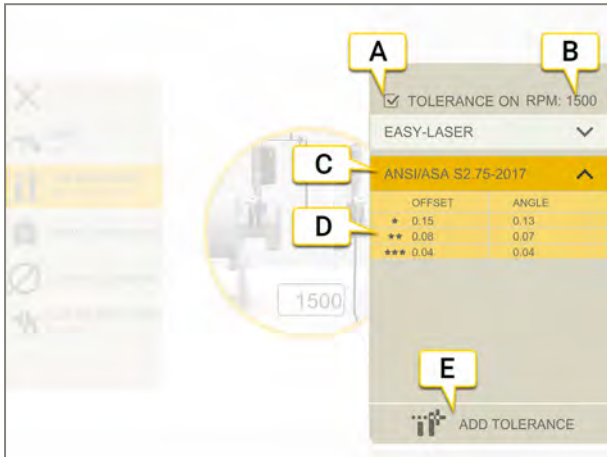

- A. Turn tolerance on/off.
- B. Current RPM.
- C. Selected tolerance.
- D. Tolerance levels.
- E. Add custom tolerance.

Built-in tolerances

The system comes with two built-in tolerances, *Easy-Laser Standard* and *ANSI standard*.

The system remembers which tolerance was last selected and will use that tolerance as the default selection when a new measurement session is created. When you set an RPM value, the tolerance is activated.

Easy-Laser

The tolerance level "good" is used for re-alignments on non-critical machinery. New installations and critical machines should always be aligned within the tolerance level "excellent".

There are two tolerance levels:

	Indicates not within tolerance. Red background.
	Good. Yellow background.
	Excellent. Green background.



ANSI standard

The ANSI/ASA S2.75-2017 standard is available. This standard has three tolerance levels:

	Indicates not within tolerance. Red background.
	Minimal. Orange background.
	Standard. Yellow background.
	Precision. Green background.

Custom tolerance



Many machines must be aligned very accurately even if they have a lower rpm. You can add your own user defined tolerance.

1. Tap .
2. Enter offset and angle values.
3. Tap  to add the custom tolerance.

There are two tolerance levels for custom tolerances.

Name the machine

Use if you want to change the default names on the machines. The name is visible in the report.

1. Tap  on the machine.
2. Tap .
3. Tap the text input field to change the name.

MEASURE





The measuring positions are registered at positions 9, 12, 3 o'clock.

Preparations

Before you start measuring, make sure you have done the preparations you need.

- Mount the measuring units.
- To calculate results, you need to enter the distance between the measuring units.
- Tap a target to connect measuring units. See "Select measuring units" on page 37
- If needed, perform a rough alignment.

Measure

1. Position the units at 9 o'clock, at bolt number one. Make sure that it is possible to also position the units at 12 and 3 o'clock.
2. Tap  to register the first position.
3. Turn shafts to 12 o'clock.
4. Tap  to register the second position.
5. Turn shafts to 3 o'clock.
6. Tap  to register the third position.
7. Tap  to go to the Result view, or tap  to measure again.

The registered values are saved when you leave the Measure view. If you return to the Measure view, it is possible to do a new measurement.

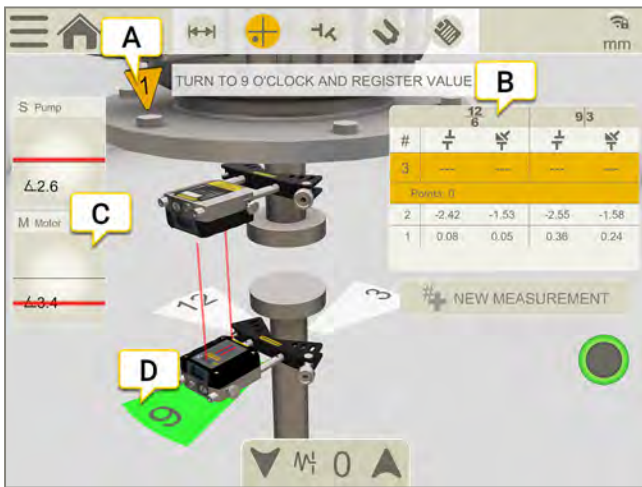

- A. The first bolt. Placed at 9 o'clock.
- B. The table displays offset and angle values in the directions 12-6 and 9-3 o'clock.
- C. Tap to display detector information.
- D. Yellow = registered position.
Green = turn shafts to green area.

Edge warning

When the laser beam is close to the edge, the edge is "lit up" as a warning. It is still possible to register values when the edge warning is active.

RESULT

The result is displayed as sideways offset in the coupling and angular error between shafts. In the directions 12-6 and 9-3. Tap  if you want to adjust the machine. After you have adjusted, it is possible to go back to the Result view.

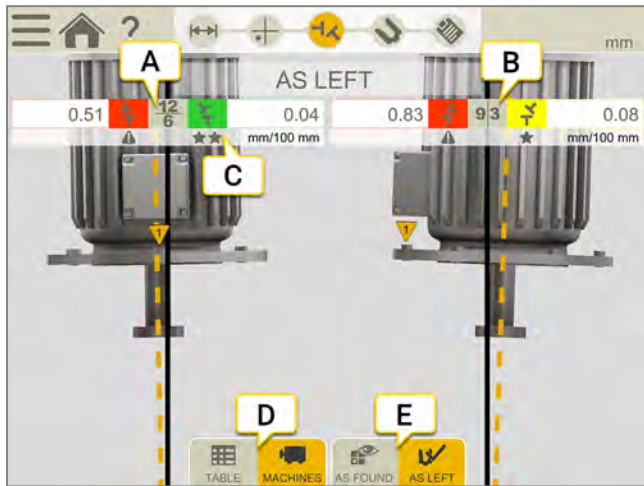



- A. Values are displayed live in the direction 12-6.
- B. Values are displayed live in the direction 9-3.
- C. Tolerance indicators. See "Tolerance" on page 146.
- D. Show Table or Machine view. See "Result table" on the next page.
- E. Show "As found" or "As left" values.

NOTE! For some machine configurations the 3D result may not be accurate. It is intended as a guide and may not always show the right rotation and position of the machine. The displayed values for feet and coupling errors are always accurate and should be followed in the event that the 3D result indicates otherwise.



As found or As left

On the tabs, it is possible to toggle between showing As found or As left values.

	As found is the latest measurement you made before making an adjustment.
	As left is the latest adjusted result. Available if you have gone to the Adjust view (and shown live values) and returned to Result view.

Show Gap

By default, angular error/100 mm is displayed. To show gap, you need to set the coupling diameter.



To show the result as gap, tap  and .

Result table

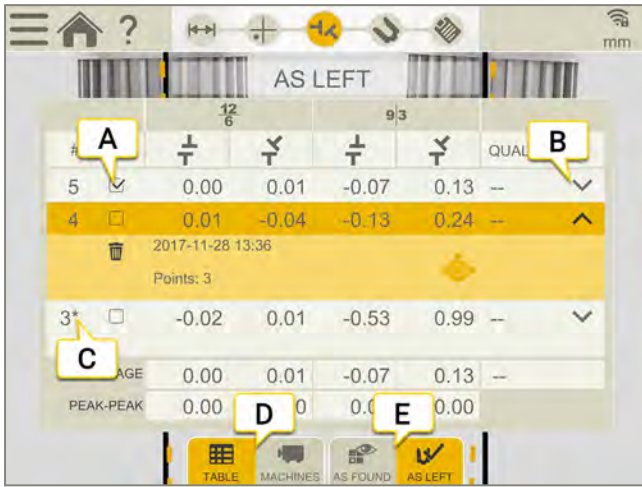
In the Result view, tap  to display the table view.



- A. Select to use the measurement in the calculations.
- B. Tap to display more information.
- C. This measurement has been adjusted.
- D. Toggle between showing machine or table view.
- E. Toggle between showing As found or As left values.

If you want delete a measurement, tap  and .

Use

By default, all measurements are included in the calculations. If you deselect measurements, the values for Average and Peak to Peak are updated. The excluded measurements are not included in the calculations, but still visible. The report will not be affected if you hide any measurements, in the report it is always the latest measurements that are shown.

NOTE! It is always the latest measurement and adjustment that are shown in the report.

Average

The average offset and angle values. Calculations are based on the measurements marked as "Use".

Peak to peak

The total variation in offsets and angles. Calculations are based on the measurements marked as "Use".

ADJUST

1. Compare the offset and angular error to the tolerance demands.
2. If the angular error need to be adjusted, please shim the machine first, then adjust the offset.
3. Tighten the bolts and remeasure.

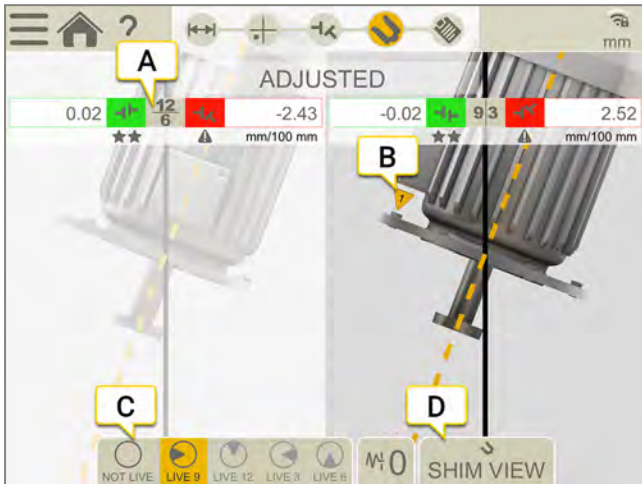





- A. Values are displayed live in the direction 12-6 or 9-3.
- B. The first bolt is placed at 9 o'clock.
- C. Live positions.
- D. Open the Shim view. See "Shim values" on the next page.

Live positions



1. Turn the shafts with detectors to a live position.
2. Tap the corresponding live option, see below.
3. Tap  before you leave the live position.

Live options:

	Not live. If you want to change live position, you need to select this first and then the new position.
	Live at 9 o'clock.
	Live at 12 o'clock.
	Live at 3 o'clock.
	Live at 6 o'clock.

Shim values

To view this, you need to enter number of bolts and diameter of bolt circle on the Prepare view.

1. Select  to open Shim value view. The values are not live.
2. Read the values. The highest bolt is calculated as 0.00. Values below zero indicates that the bolt is low and need shimming.
3. Select  to return to the Result view. If you have adjusted the machine, you need to remeasure the coupling.

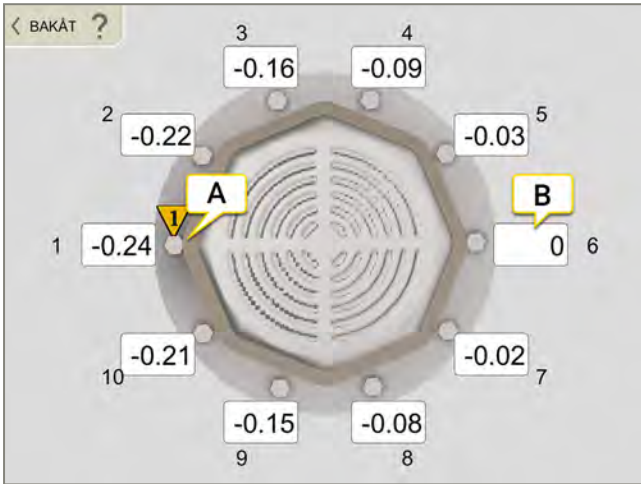



- A. First bolt at 9 o'clock.
- B. The highest bolt is calculated as 0.00.

NOTE! If you shim the machine, remeasure from position 9 o'clock to update all measurement values.

VERTICAL REPORT

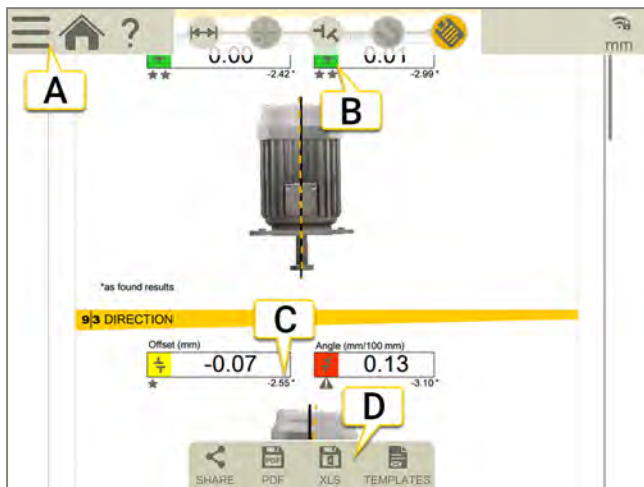
The report covers all details from the measurement. The report is constantly being filled out while the session is carried out. To see the report at its current state, tap  in the workflow.



- Tap  and  to finalize the measurement. See "Finalize" on page 8
- Green = within tolerance.
- The "As found" result is marked with an asterisk (*).
- Save as a Pdf or Excel file. The files are saved in the File manager. The functions Share and Save as Pdf or Excel file are available after the measurement has been finalized.

For information on how to:

- Change the template
- Add a note
- Add a photo
- Change user information
- Save a report
- Share a report to USB



See " Report Overview" on page 14.

CARDAN

OVERVIEW CARDAN



The Cardan program is used for alignment of cardan-shaft-coupled/centeroffset machines.
Measuring units that can be used: XT50, XT60 and XT70.

Measuring methods

	EasyTurn™ The EasyTurn™ function allows you to begin the measurement process from anywhere on the turn. You can turn the shaft to any three positions with as little as 20° between each position to register the measurement values. An easier-to-use version of the 9–12–3 method.
	9-12-3 Measurement points are recorded at fixed points 9, 12 and 3 o'clock. This is the classic three-point method which can be used in most cases.
	Multipoint Multipoint is basically the same as EasyTurn™, but instead you can record multiple points on the sector rotated. This will provide an optimized calculation basis. Perfect for e.g. turbine and sliding bearing applications.

Workflow Cardan



The workflow on the top of the screen will guide you through your work. The current view is marked yellow. The report is constantly being filled out while the session is carried out. To see the report at its current state tap  in the workflow. The measurement is saved automatically through the entire workflow.

When you have finished the measurement, tap  and  to finalize it.



Prepare view is active in the workflow

Create a template

1. Tap  and .
2. Enter a new name or keep the default name. The template is saved in the File manager.

See "Templates for measurements" on page 12.

PREPARE

Remove the cardan shaft and mount the measurement units.



- A. M-unit on the movable (M) machine. This is the adjustable shaft.
- B. S-unit on arm bracket.
- C. Stationary (S) machine. This is the non adjustable shaft.

Mount the equipment

1. Remove the cardan shaft.
2. Mount the arm bracket on the S machine. You can use the magnet bases or the mount the bracket directly on the flange.
3. Mount the S-unit on the arm bracket.
4. Mount the magnetic M bracket on the movable machine.
5. Mount the M-unit on the bracket.
6. Cone the laser beams. See "Cone the laser beam" on the facing page

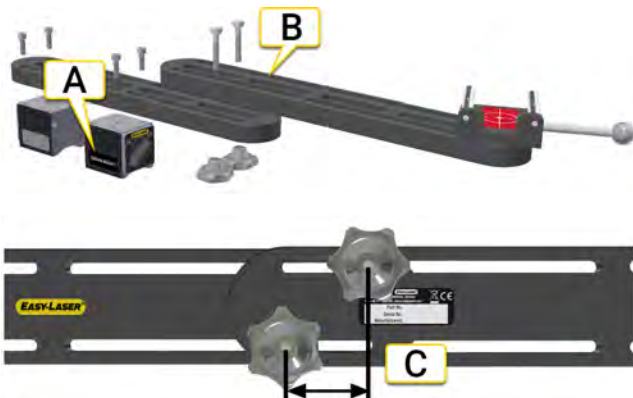

Arm bracket for the S-unit

- A. Mount the magnet bases. Note! Only use the magnet bases delivered with the system, marked "Cardan Bracket".
- B. Use two arm brackets for large offsets. The arm bracket has an offset range of 0 - 800mm.
- C. At least 40mm between the screws.

NOTE! Make sure that the measuring units are charged.

Cone the laser beam

If needed, perform a "rough coning" using a piece of paper.

1. Place both brackets at 12 o'clock.
2. Place a piece of paper between the rods and the target on the M bracket.
3. Make a mark where the laser beam hits the paper.
4. Rotate the S-unit 180°. Use the handle.
5. Make a mark where the laser beam hits the paper.
6. Adjust the laser beam to the middle between the two marks. Use the screws on the S-unit.
7. Repeat the procedure with the M-unit.

Cone from S to M

1. Place both units at 12 o'clock.
2. Move the M-unit upwards to show the target on the bracket, see image below.
3. Note where the laser beam hit the target on position **A**.
4. Rotate the S-unit 180°. Use the handle.
5. Note where the laser beam hits the target on position **B**.
6. Draw a line between the positions and mark the middle point between position A and B.
7. Adjust the laser beam to the middle point, **C**. Use the screws on the S-unit.

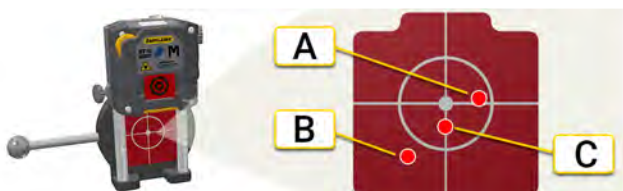

M-machine. The target is visible on the bracket.

8. Rotate the S-unit 180° again. If the laser beam does not move when you rotate, it is correctly coned. If it moves more than 3mm, repeat step 3 – 7.
9. Loosen the screws on the bracket and adjust until the laser beam hits the **center** of the target on the M-bracket.



Loosen screws to adjust the S-bracket

Cone from M to S

1. Place both units at 12 o'clock.
2. Move the M-unit down on the rods to place it in measuring position.
3. Move the S-unit upwards to show the target, see image below.
4. Note where the laser beam hit the target on position **A**.
5. Rotate the M-unit 180°. Use the handle.
6. Note where the laser beam hit the target on position **B**.
7. Draw a line between the positions and mark the middle point between position A and B.
8. Adjust the laser beam to the middle point, **C**. Use the screws on the M-unit.
9. Rotate the M-unit 180° again. Use the handle. If the laser beam does not move when you rotate, it is correctly coned.

CARDAN

If it moves more than 3mm, repeat step 4 – 8.

10. Adjust the movable machine until the laser beam hits the **center** of the target on the S bracket.

Make sure that the laser beams hit the target centers on **both** brackets.

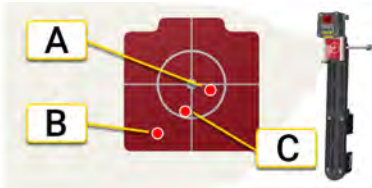

*S-machine. The target is visible on the **bracket**.*

Adjust laser beams

Now you will adjust the laser beam to the centers of the target on the **measuring units**.

1. Move both units down on the rods to measuring position.
2. Place both units at 12 o'clock.
3. Adjust the laser beam until it hits the center of the M target (**A** in image below). Use the screws on the S-unit.
4. Adjust the laser beam until it hits the center of the S target (**B** in image below). Use the screws on the M-unit.



- A. Adjust S-unit to center of the M target.
- B. Adjust M-unit to center of the S target.

Enter distances

On the Prepare view, you enter machine and coupling properties. It is possible to go back to the Prepare view later and enter/alter information.

Tap any distance input field to enter distance. The field is zoomed in and the keyboard is displayed. It is possible to skip all distances and go directly to Measure view. If you change a distance later on, the result is recalculated.

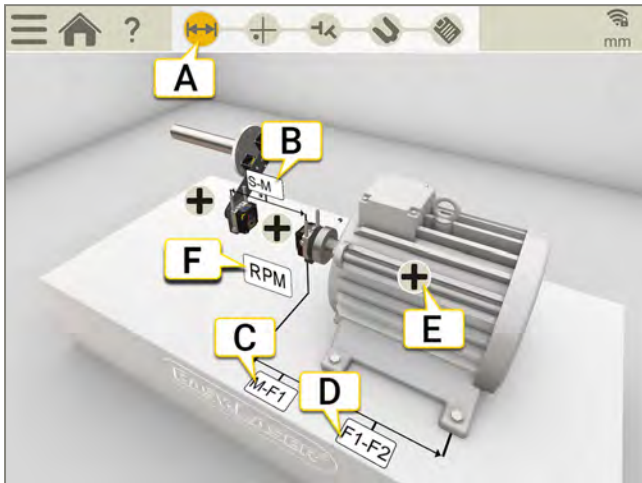

- A. Prepare view is active in the workflow.
- B. Distance between S-unit and M-unit. Measure between the rods. Required if you want to calculate an angle result.
- C. Distance between M-unit and foot one. It is possible to enter a negative value here.
- D. Distance between first and second foot. Required if you want to calculate feet values.
- E. Tap **+** to display a property menu for the Coupling or Machine.
- F. Enter RPM. A tolerance is automatically set to match the RPM you entered.

NOTE! All distances are required if you want to measure Softfoot.

Configuration

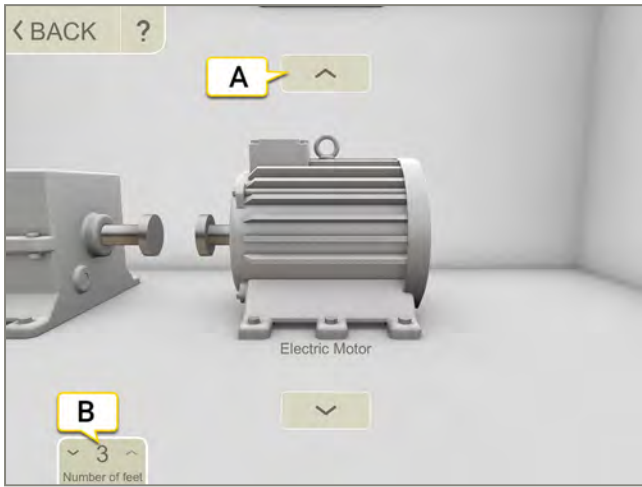

On the machine, tap  and  to open the Configuration view.



- A. Tap arrows change the machine image.
- B. Tap to change the number of feet. The possible number of feet varies depending on machine.

Tolerance

By default, a tolerance is set. You can add your own tolerance if needed.

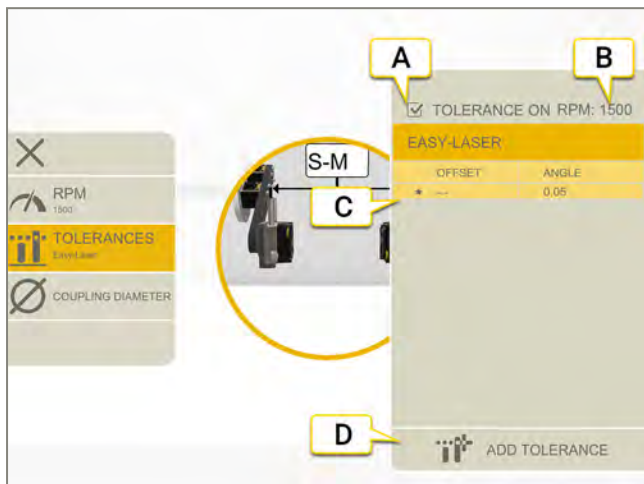

1. On the coupling, tap .
2. Tap  to display the tolerance menu.



- A. Turn tolerance on/off.
- B. Current RPM.
- C. Selected tolerance.
- D. Add custom tolerance.



Easy-Laser

This tolerance is default.

	Indicates not within tolerance. Red background.
	Good. Green background.

Custom tolerance



You can add your own user defined tolerance.

1. Tap .
2. Enter offset and angle values.
3. Tap  to add the custom tolerance.

There are two tolerance levels for custom tolerances.

Name the machine

Use if you want to change the default names on the machines. The name is visible in the report.

1. Tap  on the machine.
2. Tap .
3. Tap the text input field to change the name.

MEASURE USING EASYTURN™

Measuring units that can be used: XT50, XT60 and XT70.

With EasyTurn™, it is possible to measure with as little as 40° spread between the measurement points. However, for an even more accurate result, try to spread the points as much as possible.







Preparations

Before you start measuring, make sure you have done the preparations you need.

- Mount the measuring units.
- To calculate results, you need to enter at least the distance between the measuring units.
- Tap a target to connect measuring units. See "Select measuring units" on page 37
- Cone the laser beam. See "Cone the laser beam" on page 157.
- If needed, measure Softfoot. See "Softfoot" on page 95.

Measure

It is possible to switch measuring method before you have registered a value. Make sure to turn the measuring units equally much. If the angle between them differs more than $\pm 2^\circ$, you will be prompted to align the units.



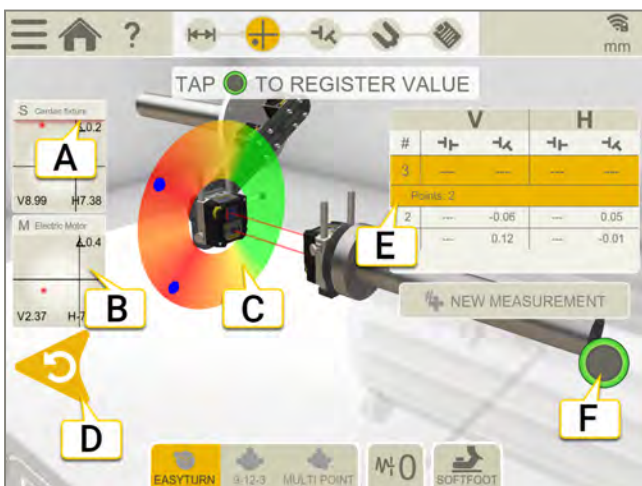

1. Tap  on the tab to select the method EasyTurn.
2. Adjust laser to the center of the targets. If needed, adjust the units on the rods, then use laser adjustments knobs.
3. Tap  to register the first position. A red marking is displayed.
4. Turn both units at least 20° (spread the points as much as possible).
5. Tap  to register the second position.
6. Turn both units at least 20°.
7. Tap  to register the third position.
8. Tap  to go to the Result view, or tap  to measure again.

The registered values are saved when you leave the Measure view. If you return to the Measure view, it is possible to do a new measurement.





- A. Edge warning. When the laser beam is close to the edge, the edge is "lit up" as a warning. It is still possible to register values when the edge warning is active.
- B. Tap to display detector information.

- C. Red = turn shafts outside the red marking.
Green = turn shafts to green area.
Blue = registered position.
- D. Delete registered value.
- E. Measurement table.
- F. This icon is grey when it not possible to register a value.

	Make a new measurement. This makes it possible to check the repeatability of the measurement.
	Measure using EasyTurn™.
	Measure using 9-12-3.
	Measure using Multipoint.
	Set Filter value.

Zero inclinometer

If the machine is mounted on an inclined base plane, you can manually set the inclinometer to a new 12 o'clock position. The following measurements will then use the new inclinometer settings.

1. Choose the measuring method you want to use.
2. Turn the measuring units so that the rods are perpendicular to the base plane.
3. Tap  and .
4. Confirm the desired position for the measuring units by tapping . The inclinometer will now be set to zero.

Your inclinometer adjustment will be applied during the whole measurement session, but will be restored when you start a new measurement from the start menu.

MEASURE USING 9-12-3

Measuring units that can be used: XT50, XT60 and XT70.

The measuring positions are registered at positions 9, 12, 3 o'clock. The inclinometers are not used.







Preparations

Before you start measuring, make sure you have done the preparations you need.

- Mount the measuring units.
- To calculate results, you need to enter at least the distance between the measuring units.
- Tap a target to connect measuring units. See "Select measuring units" on page 37
- Cone the laser beam. See "Cone the laser beam" on page 157.
- If needed, measure Softfoot. See "Softfoot" on page 95.

Measure

It is possible to switch measuring method before you have registered a value.

1. Tap  on the tab to select the method 9-12-3.
2. Adjust laser to the center of the targets. If needed, adjust the units on the rods, then use laser adjustments knobs.
3. Turn both measuring units to 9 o'clock.
4. Tap  to register the first position.
5. Turn both measuring units to 12 o'clock.
6. Tap  to register the second position.
7. Turn both measuring units to 3 o'clock.
8. Tap  to register the third position.
9. Tap  to go to the Result view, or tap  to measure again.



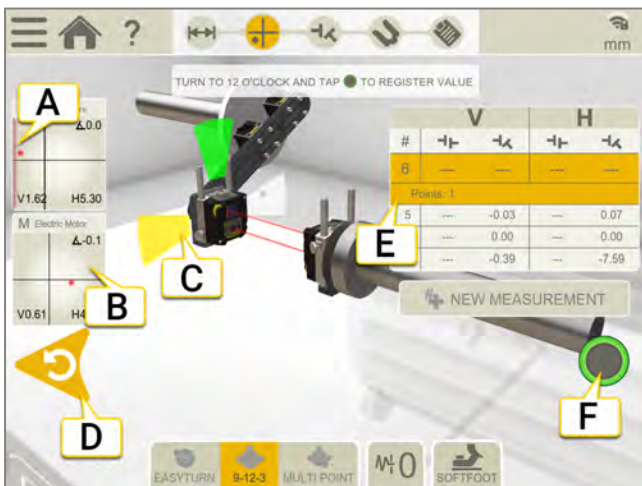



The registered values are saved when you leave the Measure view. If you return to the Measure view, it is possible to do a new measurement.



- A. Edge warning. When the laser beam is close to the edge, the edge is "lit up" as a warning. It is still possible to register values when the edge warning is active.
- B. Tap to display detector information.
- C. Yellow = registered position.
Green = turn shafts to green area.
- D. Delete registered value.

E. Measurement table.

F. This icon is gray when it not possible to register a value.

	Make a new measurement. This makes it possible to check the repeatability of the measurement.
	Measure using EasyTurn™.
	Measure using 9-12-3.
	Measure using Multipoint.
	Set Filter value.
	Measure Softfoot.

MEASURE USING MULTIPOINT

Measuring units that can be used: XT50, XT60 and XT70.

Preparations





Before you start measuring, make sure you have done the preparations you need.

- Mount the measuring units.
- To calculate results, you need to enter at least the distance between the measuring units.
- Tap a target to connect measuring units. See "Select measuring units" on page 37
- Cone the laser beam. See "Cone the laser beam" on page 157.
- If needed, measure Softfoot. See "Softfoot" on page 95.

Measure

It is possible to switch measuring method before you have registered a value.





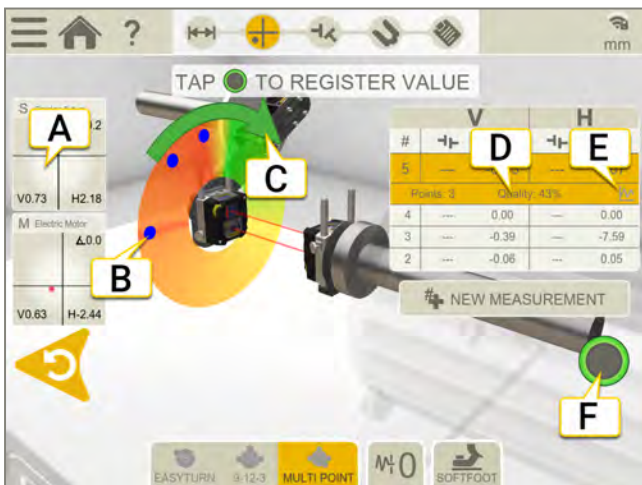

For a more accurate result, try to spread the points as much as possible. The colors indicates where the optimum positions to measure are. Green is best place to measure.

1. Tap  on the tab to select the method Multipoint.
2. Adjust laser to the center of the targets. If needed, adjust the units on the rods, then use laser adjustments knobs.
3. Make sure that both units are placed at the same angle.
4. Tap  to register the first position. The first position is automatically set to zero.
5. Turn both units to the same angle. If the angle between the units differs too much, it is not possible to register values.
6. Tap  to register as many positions as you wish. After three points a result is available.
7. Tap  to go to the Result view, or tap  to measure again.

The registered values are saved when you leave the Measure view. If you return to the Measure view, it is possible to do a new measurement.





- A. Tap to display detector information.
- B. Registered measurement point.
- C. Measurement direction.
- D. Quality assessment.
- E. Tap  to show detailed information. See "Result details" on page 101.
- F. Tap to register values.

	Make a new measurement. This makes it possible to check the repeatability of the measurement.
	Measure using EasyTurn™.
	Measure using 9-12-3.
	Measure using Multipoint.
	Set Filter value.
	Measure Softfoot.

Zero inclinometer

If the machine is mounted on an inclined base plane, you can manually set the inclinometer to a new 12 o'clock position. The following measurements will then use the new inclinometer settings.

1. Choose the measuring method you want to use.
2. Turn the measuring units so that the rods are perpendicular to the base plane.
3. Tap  and .
4. Confirm the desired position for the measuring units by tapping . The inclinometer will now be set to zero.

Your inclinometer adjustment will be applied during the whole measurement session, but will be restored when you start a new measurement from the start menu.

RESULT

In the Result view, horizontal angle, vertical angle and feet values are shown, no offset. You can go back and forth between the views Measure, Result and Adjust.

Tap  if you want to adjust the machine. After you have adjusted, it is possible to go back to the Result view.



- A. Vertical angle values.
- B. Horizontal angle values.
- C. Tolerance indicators.
- D. Vertical feet values. The locked feet is visualized with a lock .
- E. Show Table or Machine view. See "Result table" on the facing page.
- F. Horizontal feet values.
- G. Move feet lock.



NOTE! For some machine configurations the 3D result may not be accurate. It is intended as a guide and may not always show the right rotation and position of the machine. The displayed values for feet and coupling errors are always accurate and should be followed in the event that the 3D result indicates otherwise.

Lock feet

When measuring Cardan couplings, one foot is always locked on the movable machine. It is possible to move the lock. The Move lock function allows you to select which feet that are locked and which that are adjustable.

As found or As left

On the tabs, it is possible to toggle between showing As found or As left values.

	As found is the latest measurement you made before making an adjustment.
	As left is the latest adjusted result. Available if you have gone to the Adjust view (and shown live values) and returned to Result view.

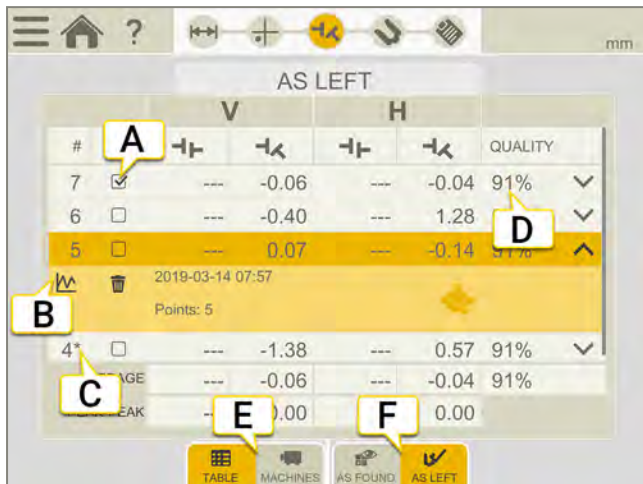

Result table

In the Result view, tap  to display the table view.



#	V	H	QUALITY
7	-0.06	-0.04	91%
6	-0.40	1.28	
5	0.07	-0.14	97%
4*	-1.38	0.57	91%
AVERAGE	-0.06	-0.04	91%
PEAK TO PEAK	0.00	0.00	

- A. This measurement is used in the calculations.
- B. Open detailed view See "Result details" on page 101
- C. This measurement has been adjusted.
- D. Quality assessment for the measurement. Available if you have used the method Multipoint.
- E. Toggle between showing machine or table view.
- F. Toggle between showing As found or As left values.

If you want delete a measurement, tap  and .

Use

By default, all measurements are included in the calculations. If you deselect measurements, the values for Average and Peak to Peak are updated. The excluded measurements are not included in the calculations, but still visible. The report will not be affected if you hide any measurements, in the report it is always the latest measurements that are shown.

NOTE! It is always the latest measurement and adjustment that are shown in the report.

Average



The average angle values. Calculations are based on the measurements marked as "Use".

Peak to peak

The total variation in angles. Calculations are based on the measurements marked as "Use".

ADJUST CARDAN

Check the machine according to the tolerance and adjust the machine if needed. No offset adjustment is made.

1. Adjust the machine vertically by shimming according to the vertical feet values.
2. Adjust the machine sideways according to the live horizontal values.
3. Tighten the feet.
4. Tap  to remeasure or tap  to view the report.

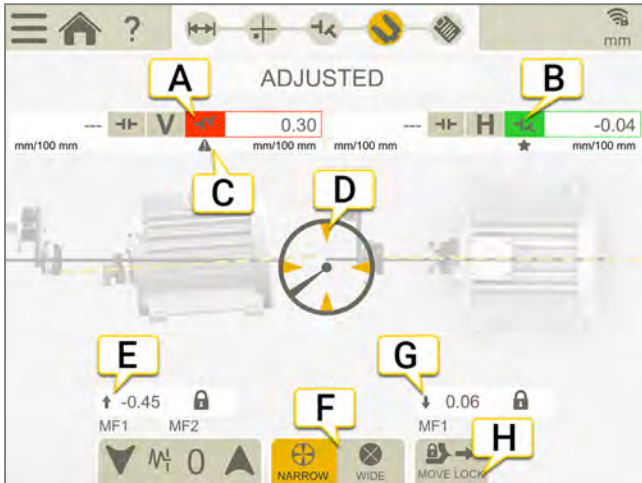



- A. Vertical angle values.
- B. Horizontal angle values.
- C. Tolerance indicators.
- D. Turn to live.
- E. Arrow shows how to adjust the vertical values.
- F. Live options, narrow or wide.
- G. Arrow shows how to adjust the horizontal values.
- H. Move feet lock.

Live values with inclinometer

With the programs EasyTurn and Multipoint, the inclinometer controls when live values are shown.

Select one of the corresponding live options:





	Narrow, live values are shown when the units are positioned within ($\pm 2^\circ$) of the clock positions.
	Wide, live values are shown when the units are positioned within ($\pm 44^\circ$) of the clock positions.

Live values without inclinometer

With the program 9-12-3 the inclinometer is not used, instead you manually show in which position your measurement units are.

1. Turn the shafts with detectors to a live position.
2. Tap the corresponding live option, see below.
3. Tap  before you leave the live position.



Live options:

	Not live. If you want to change live position, you need to select this first and then the new position.
	Live at 9 o'clock.
	Live at 12 o'clock.
	Live at 3 o'clock.
	Live at 6 o'clock.

CARDAN REPORT

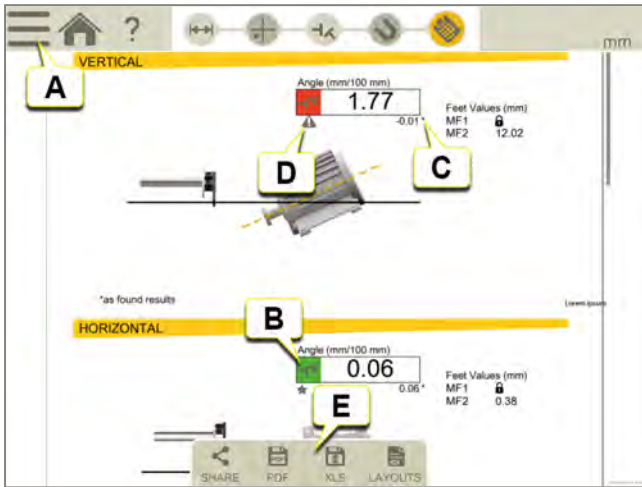
The report covers all details from the measurement. The report is constantly being filled out while the session is carried out. To see the report at its current state, tap  in the workflow.



- A. Tap  and  to finalize the measurement. See "Finalize" on page 8
- B. Green = within tolerance.
- C. The "As found" result is marked with an asterisk (*).
- D. Tolerance indicator.
- E. Save as a Pdf or Excel file. The files are saved in the File manager. The functions Share and Save as Pdf or Excel file are available after the measurement has been finalized.

For information on how to:

- Change the template
- Add a note
- Add a photo
- Change user information
- Save a report
- Share a report to USB

See " Report Overview" on page 14.

TWIST



OVERVIEW TWIST

Program to measure flatness/twist of, for example, machine foundation, machine tables, etc.

Measuring units that can be used: XT50, XT60, XT70.

Overview Twist



The workflow on the top of the screen will guide you through your work. The current view is marked yellow. The report is constantly being filled out while the session is carried out. To see the report at its current state tap  in the workflow. The measurement is saved automatically through the entire workflow.

When you have finished the measurement, tap  and  to finalize it.



Prepare view is active in the workflow

Create a template

1. Tap  and .
2. Enter a new name or keep the default name. The template is saved in the File manager.

See "Templates for measurements" on page 12.

PREPARE

If you want to measure a machine foundation made of two beams you can build a temporary reference block at the center point (marked with X in the program).

1. Make a rough alignment and enter distances.
2. Tap  to continue to Measure view.

Rough align

1. Place the S-unit close to position **A**. Make sure that the S and M-unit are on the same height. Especially important when you are using a tilt table.
2. Mark where the measurement positions are on your measurement object, to ensure that you place the detector on the same position each time. Make sure to place the center point (X) exactly in the middle.
3. Place M-unit on the position diagonal to A. Make sure that the laser beam hits the detector target.
4. Place the M-unit on position **X**. Make sure that the laser beam hits the detector target.
5. Place the M-unit on measurement position **A**.
6. Tap **0** to zero set the value.
7. Move the M-unit back to the diagonal position. Adjust the laser beam to zero (± 0.1 mm).

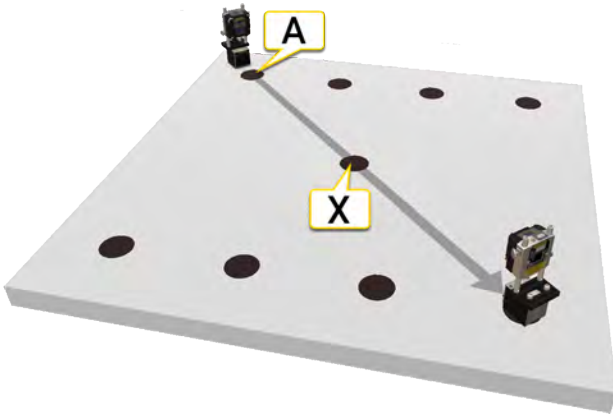

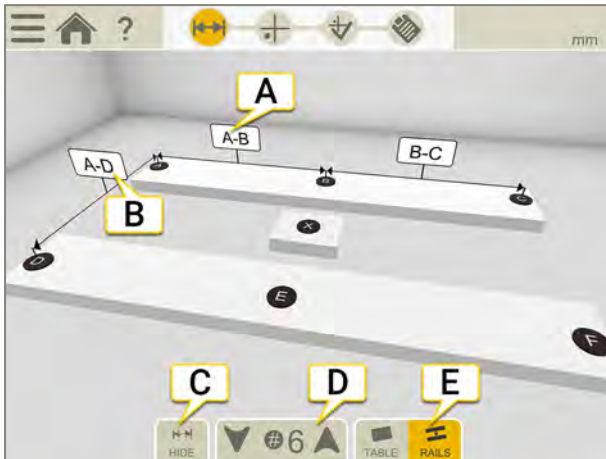

Position A and position X.

Enter distances



- A. Tap any field to enter distances.
- B. This distance is only for documentation.
- C. Hide/show distances.
- D. Select 4, 6 or 8 measurement points.
- E. Select table or beams.

MEASURE

1. Tap the target to connect measuring units.
2. Tap  to register values.
3. Tap  to display the result view.

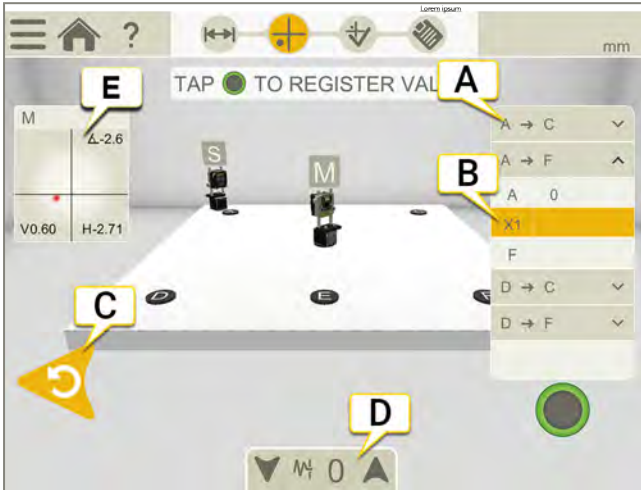

- A. Table with measurement sections.
- B. Active measurement point.
- C. Delete latest measurement point.
- D. Tap to select filter. See "Filter" on page 8
- E. Tap to select detector.

Measurement sections

The number of sections depends on how many measurement points you have selected.

- Four measurement points: only the two diagonals are measured.
- Six or eight measurement points: four sections are measured.

Example with eight measuring points

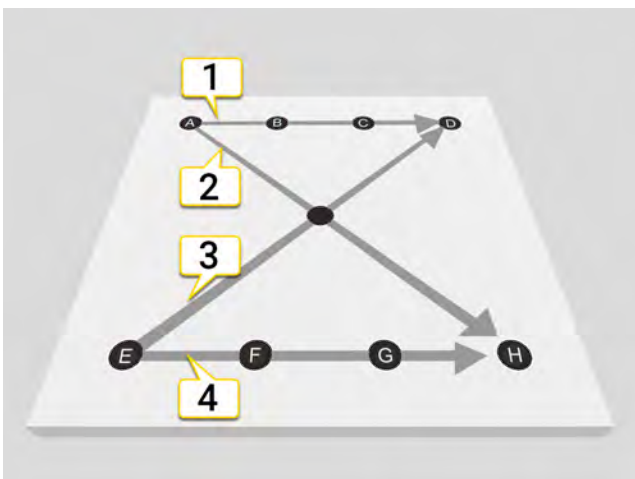

1. Section A to D
2. Section A to H

3. Section E to D
4. Section E to H

RESULT

Tap  to display the Result view. A table and a graph show the result.

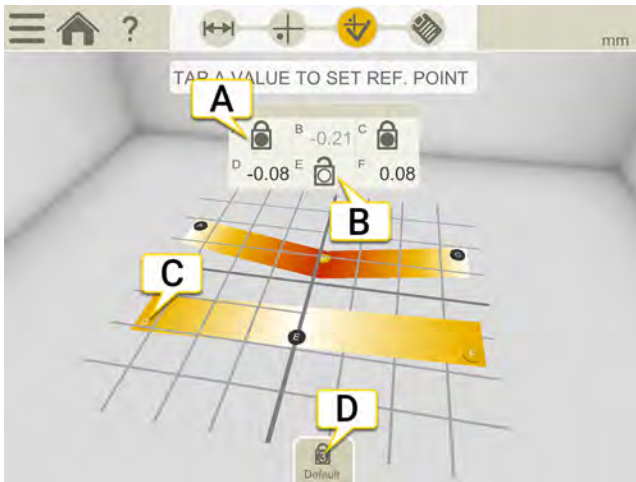



- A. Reference point.
- B. Opened reference point.
- C. Point below zero.
- D. Set default reference points.

Reference points

Default reference points

By default, a best fit is calculated with all measurement points below zero.



Custom reference points

1. Tap  in the table to open a reference point.
2. Tap a value in the table to set it as reference. Maximum two of the reference points can be in line horizontally.
3. Tap  to return to the default reference points.

TWIST REPORT

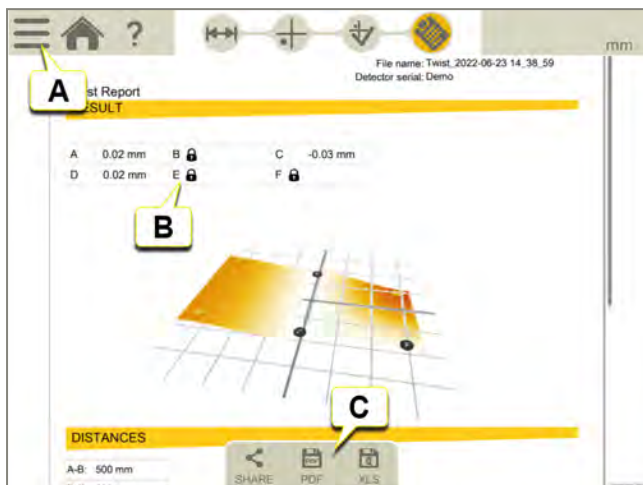
Tap  in the workflow to view the report.



- A. Tap  and  to finalize the measurement. See "Finalize" on page 8
- B. Reference point.
- C. Save as a Pdf or Excel file. The files are saved in the File manager. The functions Share and Save as Pdf or Excel file are available after the measurement has been finalized.

For information on how to:

- Add a note
- Add a photo
- Change user information
- Save a report
- Share a report to USB

See "Report Overview" on page 14.



BASIC FLATNESS

OVERVIEW BASIC FLATNESS

Use this program to measure flatness on for example machine foundations.

Equipment that can be used: XT70 (M-unit) together with a laser transmitter.



The workflow on the top of the screen will guide you through your work. The current view is marked yellow. The report is constantly being filled out while the session is carried out. To see the report at its current state tap  in the workflow. The measurement is saved automatically through the entire workflow.

When you have finished the measurement, tap  and  to finalize it.



Prepare view is active in the workflow

Create a template

1. Tap  and .
 2. Enter a new name or keep the default name. The template is saved in the File manager.
- See "Templates for measurements" on page 12.

PREPARE

Enter distances

Two rows of measurement points is possible in Basic Flatness. A row can have 2-8 points.

If you do not enter any distances, it is assumed that the distances are symmetrical and you can still measure. If you enter one distance, please also enter the rest of the distances. Otherwise the bestfit operations will be disabled.

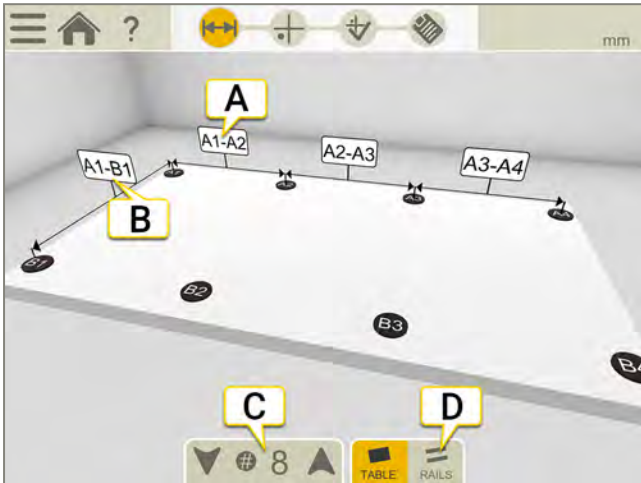

- A. Tap any field to enter distances.
- B. Distance between the two rows.
- C. Tap the arrows to select number of points. Default is 8 points. (min: 4, max: 16)
- D. Select table or beams.

Settings

Settings only for the program Basic Flatness. The settings are saved and will be default the next time you open the program.

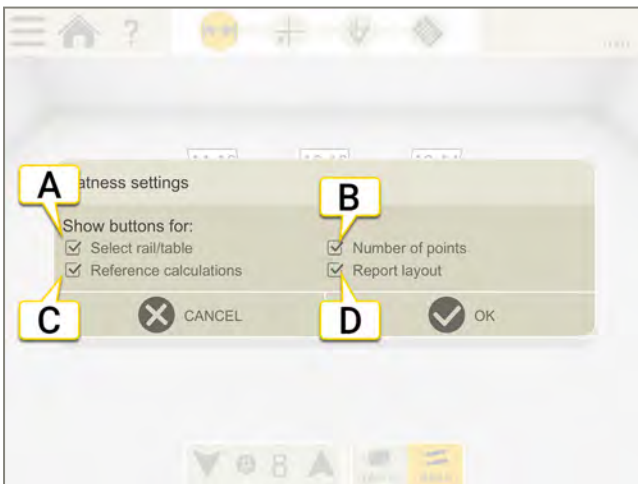

1. Tap and .
2. Select which buttons to show/hide in the program.



- Buttons to select the number of points.
- Button to show a table or rails.
- Buttons to select Best fit and Reference points calculations.
- Button to select which template to use.

Use settings in a template

The settings are useful when you want to make templates that forces the user to use certain settings. For example, you want a template that uses six points and the best fit calculation All positive.

1. Select six points on the Prepare view.
2. Select  (All positive) on the Result view.
3. Hide the options "Number of points" and "Reference calculations".
4. Tap  and  to save as a template.

See "Templates for measurements" on page 12

MEASURE

Set up

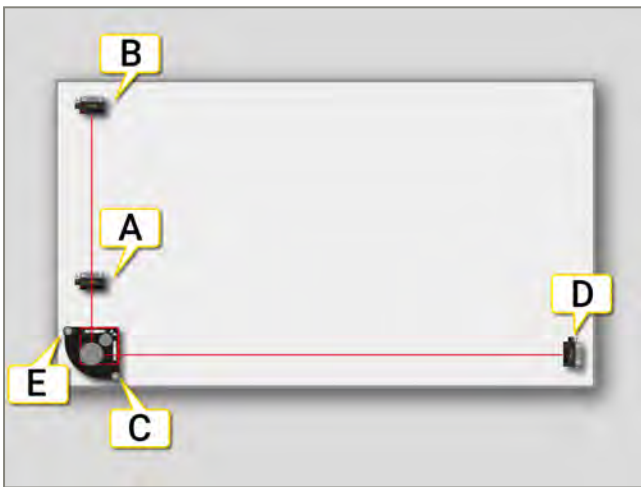

1. Place the laser transmitter on the table or mount it on a tripod.
2. Tap the target to connect the measuring unit. If you need the target to be bigger, tap .
3. Place the M-unit close to the transmitter, on point **A**.
4. Adjust the M-unit on the rods until the laser hit the center of the target.
5. Select **0** to zero set the value. This is now reference point number one.
6. Move the M-unit to point **B**.
7. Adjust the laser beam by using the screw **C** on the tilt table. Level to ± 0.1 mm.
8. Move the M-unit to point **D**.
9. Adjust the laser beam by using the screw **E** on the tilt table. Level to ± 0.1 mm.

Repeat procedure until you have all three reference points within ± 0.1 mm.



	Tap to enlarge the target.
0	Zero set the displayed value. Zero point of the target moves to the laser point.
$\frac{1}{2}$	Halve the displayed value. Zero point of the target moves halfway towards the laser point.
1	Return to the absolute value. Zero point of the target returns to the center.

Measure

1. Tap  to register values. First measured point is set to zero.
2. Tap  to display the result view.

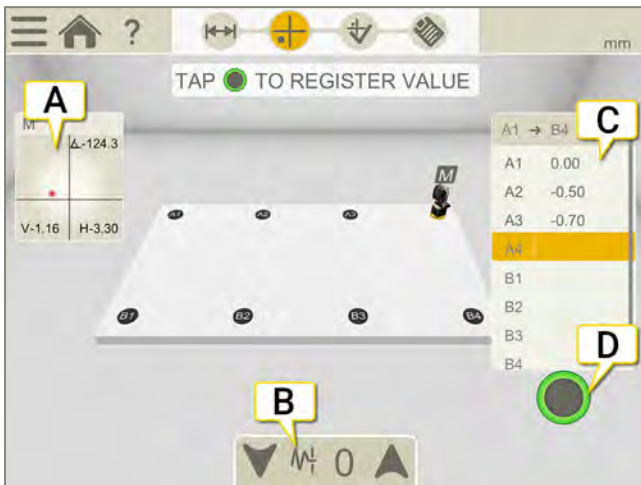

- A. Tap to select detector.
- B. Tap to select filter. See "Filter" on page 8
- C. Registered values. Tap a value to remeasure.
- D. Tap to register points.

Edge warning

When the laser beam is close to the edge, the edge is "lit up" as a warning. It is still possible to register values when the edge warning is active.

RESULT



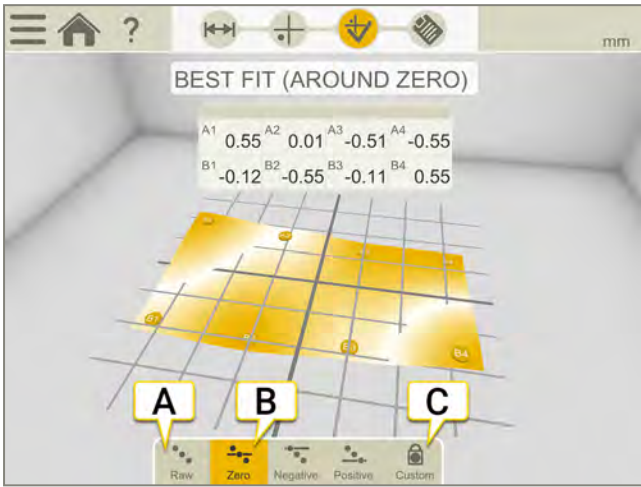

Tap  to display the Result view. A table and a graph show the result. You can try different settings and analyze the measurement result directly in the Display unit.



- A. Raw values.
- B. "Best fit around zero" is the selected in this example.
- C. Set custom reference points.

Reference modes

When you perform a best fit calculation, the object is tilted to the lowest peak to peak value. It is fitted as flat as possible between two planes.

	Raw values.
	Zero. When you perform a best fit calculation, the measurement object is tilted to the lowest peak to peak value. It is fitted as flat as possible between two planes where the average value is zero.
	Negative. Best fit with all measurement points below 0. The reference line is moved to the highest measurement point.
	Positive. Best fit with all measurement points above 0. The reference line is moved to the lowest measurement point.

Reference points

The measurement values can be recalculated so that any three of them become zero references, with the limitation that a maximum of two of them are in line horizontally or vertically in the coordinate system. (If there are three in line, it is just a line and not a plane!). Reference points are needed when you are going to machine the surface.

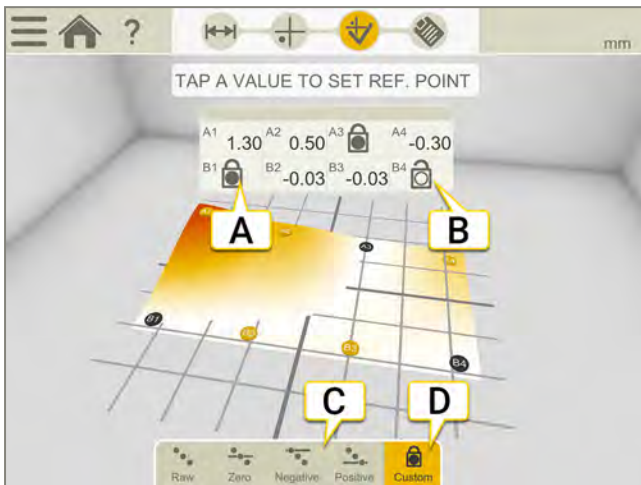

- A. Reference point.
- B. Opened reference point.
- C. Different best fit calculations.
- D. Set custom reference points is active. By default, a best fit is calculated using global peak to peak.



Set custom reference points

1. Tap  in the table to open a reference point.
2. Tap a value in the table to set it as reference. Maximum two of the reference points can be in line horizontally or vertically.

BASIC FLATNESS REPORT

Tap  in the workflow to view the report.



- A. Tap  and  to finalize the measurement. See "Finalize" on page 8
- B. A best fit calculation has been used.
- C. Share the report.
- D. Save as a Pdf or Excel file. The files are saved in the File manager. The functions Share and Save as Pdf or Excel file are available after the measurement has been finalized.

For information on how to:

- Change the template
- Add a note
- Add a photo
- Change user information
- Save a report
- Share a report to USB

See " Report Overview" on page 14.

STRAIGHTNESS



OVERVIEW

The program Straightness is used for machine foundations, shafts, bearing journals and other straight structures.



The basic principle for straightness measurement is that all measurement values will show the position of the detector unit relative to the laser beam. First, the laser beam is roughly aligned along the measurement object. The detector is then positioned on the selected measuring points and the values registered.

Laser transmitters to be used: XT20/XT22, XT70-S and D22.

Measuring unit detectors to be used: XT70-M and XT9.

In the Start Menu, tap  and then  to open the program.

The workflow on the top of the screen will guide you through your work. The current view is marked yellow. The report is constantly being filled out while the session is carried out. To see the report at its current state tap  in the workflow. The measurement is saved automatically through the entire workflow.

When you have finished the measurement, tap  and  to finalize it.



Workflow: Prepare view is active.

PREPARE

Enter distances automatically

When the distances between all measurement positions are equal, it is recommended that you enter distances automatically.



- A. Prepare icon is active in the workflow.
- B. Enter the number of measurement positions to be measured.
- C. Enter start measurement position.
- D. Enter end measurement position.
- E. Automatically calculated distances between measurement positions.
- F. Tap to set tolerances for vertical and horizontal offset.
- G. When all measurement position values are entered, tap "Complete".

Enter distances manually

When the distances between the measurement positions are unequal, you must enter distances manually.



- A. After tapping "Complete" (see [G] above), you can enter measurement position distances manually.
- B. Enter the number of measurement positions to be measured.
- C. Add new measurement position or delete selected bore position.
- D. Enter names for each measurement position.

CONNECT

In the "Connect" view you select the measuring devices you wish to connect.

Type of device and serial number are displayed in the Live Device view below [C].

NOTE! Once you have registered a measurement value you can not return and change your device setup.

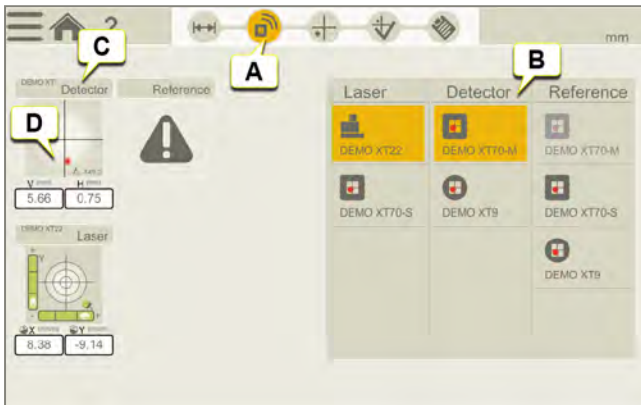

- A. Tap Connect icon in the workflow.
- B. Select the devices you want to connect. Tap selected device to disconnect.
- C. Device type and serial number.
- D. Live detector PSD for Setup of the laser beam, tap to enlarge live reading and to zero set/halve value.

Reference detector

It is possible to connect a reference detector (XT-70 S, XT70-M or XT9) in Connect view. When using a reference detector, you can monitor any movement of the laser beam during a measurement.



- A. Select the reference detector you want to connect. Tap selected device to disconnect.
- B. Device type and serial number.
- C. Live Reference detector PSD, tap to enlarge live reading and to zero set/halve value.
- D. Zero set and halve value when live device is zoomed in.

Enlarge a specific live reading

Tap the Live Device View to open Context menu and tap "ZOOM". This is useful when you need to read from a distance during Set up procedure. See "Measure".

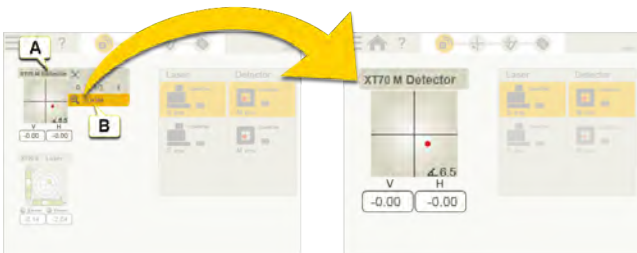

- A. Tap the Live Device View to open Context menu.
- B. Tap to enlarge selected live reading.

Set resolution and angular unit for Laser Transmitter XT20 and XT22

Tap the Live Device View to open Context menu and tap "RESOLUTION". Set resolution (number of decimals) and angular unit for XT20/XT22. The resolution and angular unit in the XT20/XT22 measuring display will be the same as the settings in the app.

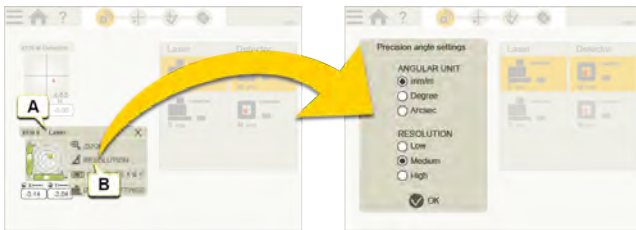

- A. Tap the Live Device View to open Context menu.
- B. Tap to set angular unit and resolution.

Calibrate Laser Transmitter XT20 and XT22

Tap the Live Device View to open Context menu and tap "CALIBRATE". Calibrate XT20/XT22 electronic levels horizontally by following the Calibration guide in the app.

See "Calibrate XT20/XT22 electronic levels horizontally" on page 266

See "Calibrate XT22 electronic level vertically" on page 269





- A. Tap the Live Device View to open Context menu.
- B. Tap to calibrate laser transmitter.

NOTE! If you want to use electronic levels, these must be calibrated before you start measuring.

MEASURE



Set up and measuring procedure

1. Select "Measure"  in Workflow.
2. Place the laser transmitter [A] on the object to be measured.
3. Place the detector [B] as close as possible to the laser transmitter.
4. Adjust the laser transmitter horizontally and the detector vertically on the rods, until the laser hits the center of the detector PSD (close to 0.00).
5. Select  to zero set the value (see "Halve or zero set value for a specific detector live reading" below). This is now set up point number one (mark the set up point on the object to be measured).
6. Move the detector to point [C], the farthest point to be measured.
7. Aim the laser beam, by using the laser adjustment screws [D], to hit the center of the detector PSD (close to 0.00). This is now set up point number two.
8. Repeat step 5-7 and fine adjust the set up points.
9. Register measurement values on selected distances [E], see "Measure" below. Distances are always measured from the first point [F]. Do not touch the laser transmitter.
10. Choose reference points, for example first and last measurement points.

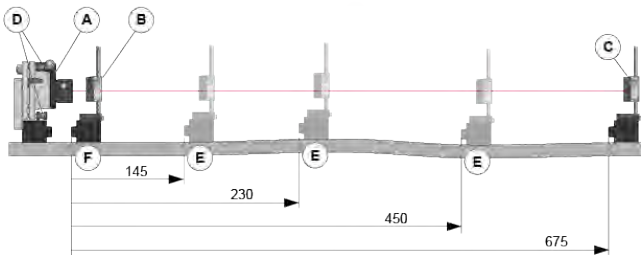
NOTE! The more accurate you are when setting the laser beam parallel to the object to be measured, the more accurate the measurement result will be.



Measure

1. Tap "Measure"  in the workflow, see *Measure view below*.
2. Tap  to register values.
3. To remeasure, select a registered measurement point in the list and tap , see *Measure view below*.

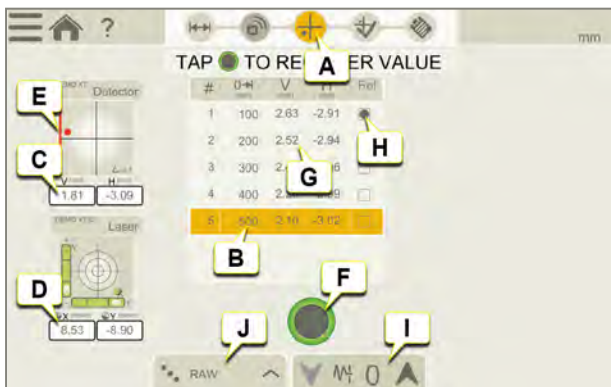

Measure view.

- A. Measure icon is active in the workflow.
- B. Measurement position.
- C. Live reading of detector.
- D. Live reading of laser transmitter.
- E. Edge warning. When the laser beam is close to the edge, the edge is "lit up" as a warning. It is still possible to register values when the edge warning is active, but the measurement accuracy may be reduced.
- F. Tap to register measurement value for active measurement position.
- G. Registered measurement values.
- H. Reference point. To select reference point, first tap "Reference" in Reference modes.
- I. Tap to select filter for detector. See "Filter" on page 8
- J. Reference modes.

Measure with reference detector

When measuring, you can check the value from the reference detector by pressing the Device button. It is only possible to monitor the values from the reference sensor.

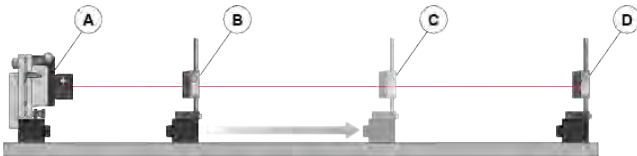

- A. Laser transmitter.
- B. M unit detector.
- C. M unit detector at farthest point to be measured.
- D. S unit used as reference detector during Measuring-procedure, placed beyond farthest point to be measured. Zero set value when live device is zoomed in (remove M unit detector [C] when checking the reference detector).

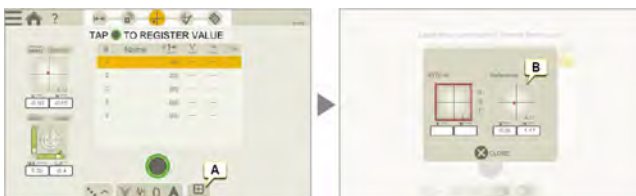

- A. Tap to display Reference detector Live Device.
- B. Zero set and halve the value when Live Device is displayed. This does not affect the measurement.

An XT70-S can be used as reference detector. To set it to Reference mode, see below. When set to Reference mode the XT70-S display will show an "R". Other detectors that can be used as reference detectors are XT70-M and XT9. These detectors will not show an "R" when set to reference mode.



Display showing an "R" when XT70-S is set to Reference mode.

STRAIGHTNESS

NOTE! The XT70-S unit will behave as an M unit when "Reference mode" is selected in the app, meaning M values are shown in the display. This is indicated by an "R". The XT70-S unit is automatically set to "Reference mode" during the entire measurement session. The XT70-S will go back to "normal mode" when disconnected from the app.

NOTE! "Reference mode" will automatically be switched off when you change program, for example to "Shaft".

Tolerance

By default, no tolerance is set. To set tolerance, add preferred values.

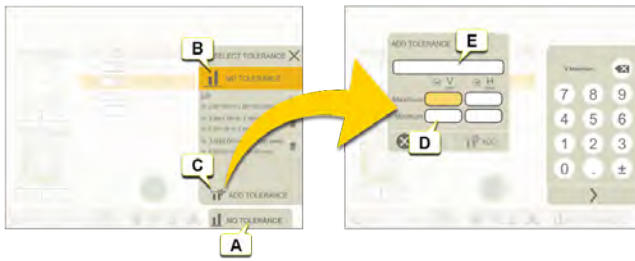

- A. Tap to set tolerances.
- B. No tolerance (default).
- C. Add tolerance.
- D. Set tolerances for vertical and horizontal offset on the keyboard.
- E. If you like to give the tolerance a specific name, write it here.

Reference modes

When you perform a best fit calculation, the object is tilted to the lowest peak to peak value. It is fitted as straight as possible between two planes.

	Raw values.
	Zero. When you perform a best fit calculation, the measurement object is tilted to the lowest peak to peak value. It is fitted as flat as possible between two planes where the average value is zero.
	Negative. Best fit with all measurement points below 0. The reference line is moved to the highest measurement point.
	Positive. Best fit with all measurement points above 0. The reference line is moved to the lowest measurement point.
	Average. The reference line is moved to the average value of the measurement points.
	Set custom reference point.

Halve or zero set value for the detector live reading

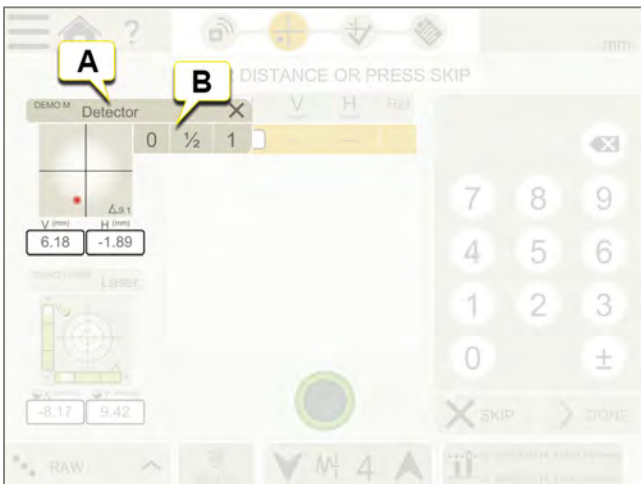

- A. Tap the Live Device View to open Context menu.
- B. Tap "0" to zero set, "1/2" to halve value or "1" to return to the absolute value.

Device settings for XT20 and XT22

Tap the Live Device View to open Context menu and tap "DEVICE SETTINGS". Set Display view, Filter level and activation/deactivation of Shake warning and Temperature warning.

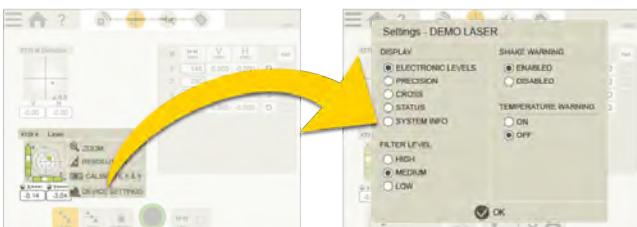

Warnings during measurement

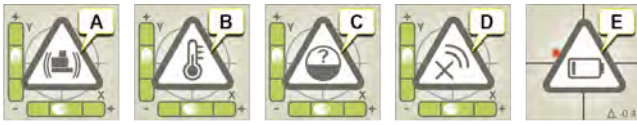

The following Warnings may appear in the Live Device information:



- A. Shake warning for laser transmitter. Deactivate by selecting Shake warning "OFF" in the XT app. If vibrations are strong enough to make the shake warning appear during measurement, increase the filter level of electronic levels from the XT app.
- B. Temperature warning for laser transmitter. Deactivate by selecting Temperature warning "OFF" in the XT app.
- C. No angular information is available. The electronic levels and inclinometers of the laser transmitter are out of range. Please position the transmitter closer to horizontal or vertical level.
- D. Device disconnected.
- E. Low battery warning. Charge the measuring device.

RESULT

Tap  to display the Result view. A table or a graph shows the result. Different settings of the references can be made to present the measurement results directly in the Display unit before you move on to "Report"

Tap  and  to finalize the measurement. The measurement is saved in the File manager.

NOTE! As long as you haven't finalized the result you can return to "Measure" and continue to register values.

Table view



- A. Result icon is active in the workflow.
- B. Measurement positions.
- C. Measurement distances.
- D. Measurement result.
- E. Green measurement result is within tolerance, red measurement result is outside tolerance.
- F. Statistics for the measurement data.
- G. Notes (visual in Report), reached via hamburger menu.
- H. Tolerances.
- I. Reference modes.
- J. Table view selected.

Graph view

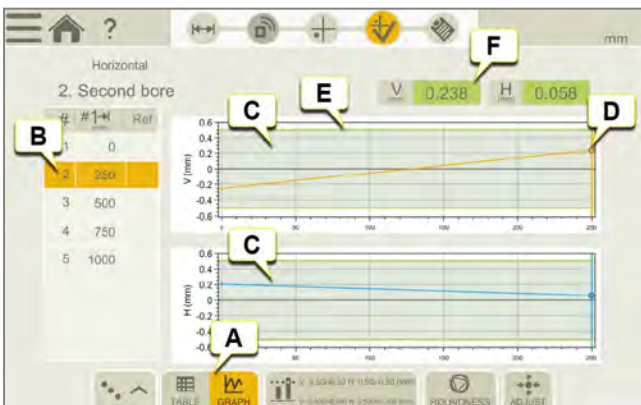



- A. Toggle between table and graph view.
- B. Selected measurement position.
- C. Graphs showing vertical and horizontal visual representation of the measurement results.
- D. Selected measurement position is highlighted in the graph.
- E. Green borders indicate set tolerances.
- F. Value for selected measurement position. Green indicates within tolerance.

REPORT

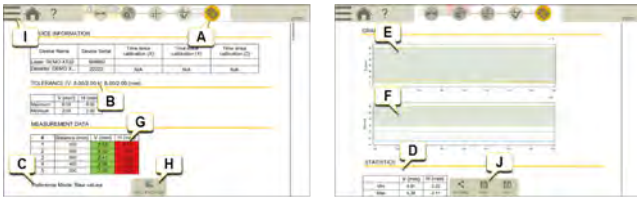
The report covers all details from the measurement. The report is constantly being filled out while the session is carried out. To see the report at its current state, tap  in the workflow.



- A. Report icon is active in the workflow.
- B. Tolerances.
- C. Reference mode.
- D. Statistics.
- E. Graph for V values.
- F. Graph for H values.
- G. Table with points and measurement values, Vertical and Horizontal.
- H. Add photos (not applicable if you have finalized the measurement).
- I. Tap  and  to finalize the measurement. See "Finalize" on page 8
- J. Save as a Pdf or Excel file. The files are saved in the File manager. The Share and Save functions are available after the measurement has been finalized.

For information on how to:

- Change the template
- Add a note
- Add a photo
- Change user information
- Save a report
- Share a report to USB

See " Report Overview" on page 14

BORE CENTER

OVERVIEW



The basic principle of the program Bore Center is to show the position of the bore center in relation to the laser beam. This is essential when measuring for example bearing journals in propeller shaft installations and diesel engines.

Laser transmitters to be used: XT24 and D75.

Measuring unit detectors to be used: XT9 and XT70-M.

In the Start Menu, tap  and then  to open the program Bore Center.

The workflow on the top of the screen will guide you through your work. The current view is marked yellow. The report is constantly being filled out while the session is carried out. To see the report at its current state tap  in the workflow. The measurement is saved automatically through the entire workflow.

When you have finished the measurement, tap  and  to finalize it.



Workflow: Prepare view is active.

PREPARE

Enter distances automatically

When the distances between all bore positions are equal, it is recommended that you enter distances automatically.

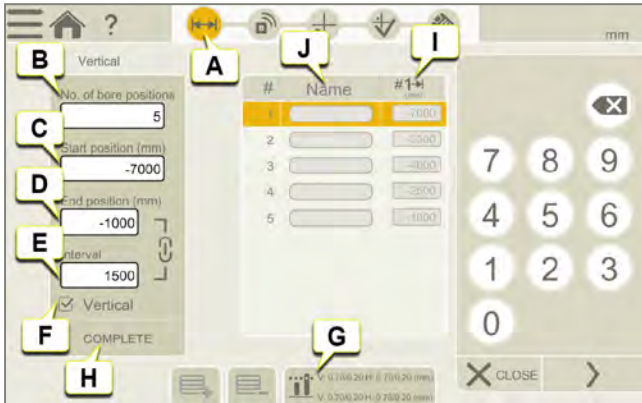

- A. Prepare icon is active in the workflow.
- B. Enter the number of bore positions to be measured.
- C. Enter start bore position.
- D. Enter end bore position.
- E. Automatically calculated distances between bore positions.
- F. Select vertical mode (for more information, see NOTE! below).
- G. Tap to set tolerances for vertical and horizontal offset.
- H. When all bore position values are entered, tap "Complete".
- I. Indicates that distance is measured from the first bore position.
- J. Enter names for Bore positions.

Enter distances manually

When the distances between the bore positions are unequal, you must enter distances manually.



- A. After tapping "Complete" (see [G] above), you can enter bore position distances manually.
- B. Enter the number of bore positions to be measured.
- C. Add new bore position or delete selected bore position.
- D. Enter names for each bore position.

NOTE! Vertical mode is used for vertical bore alignment and disables the values from the inclinometers. Only 2-point, 4-point or manual entry can be used in vertical mode.

CONNECT

In the "Connect" view you select the measuring devices you wish to connect.

Type of device and serial number are displayed in the Live Device view below [C].

NOTE! Once you have registered a measurement value you can not return and change your device setup.

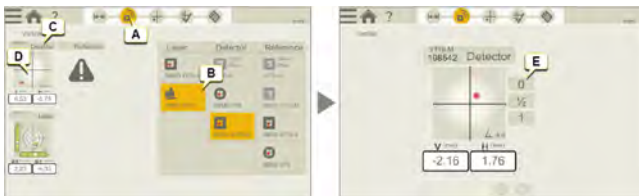

- A. Tap Connect icon in the workflow.
- B. Select the devices you want to connect. Tap selected device to disconnect.
- C. Device type and serial number.
- D. Live detector PSD for Setup of the laser beam, tap to enlarge live reading and to zero set/halve value.
- E. Zero set and halve value when live device is zoomed in.

Reference detector

It is possible to connect a reference detector (XT-70 S, XT70-M or XT9) in Connect view. When using a reference detector, you can monitor any movement of the laser beam during a measurement.



- A. Select the reference detector you want to connect. Tap selected device to disconnect.
- B. Device type and serial number.
- C. Live Reference detector PSD, tap to enlarge live reading and to zero set/halve value.
- D. Zero set and halve value when live device is zoomed in.

MEASURE

Setup of the laser beam

Stay in the Connect view  when performing setup of the laser beam.

NOTE! In this Setup example, all the bore diameters are the same.

1. Measure the bore diameter.
2. Adjust the laser transmitter bracket according to the bore diameter.
3. Mount the laser transmitter [a] and bracket to the first bore. This is now setup bore position number 1.

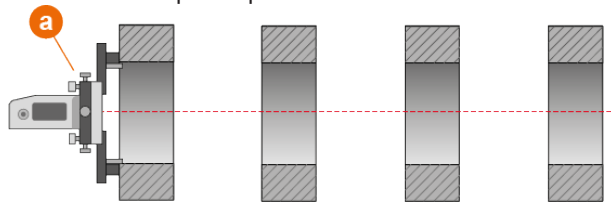

4. Place the detector [b], as close as possible to the laser transmitter. Adjust the detector on the rods until the laser beam hits the center of the detector target [c].

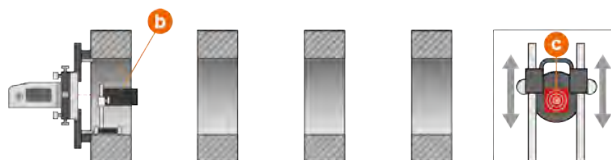

5. Rotate the detector 180° and adjust it on the rods until the laser beam hits the center of detector target [d].

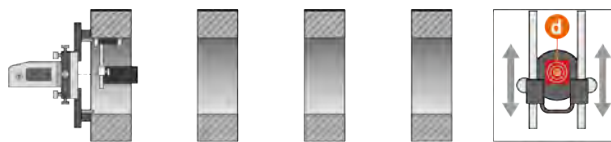

6. Move the detector to the furthest bore to be measured [e] and place it according to the picture. This is now setup bore center position number 2.

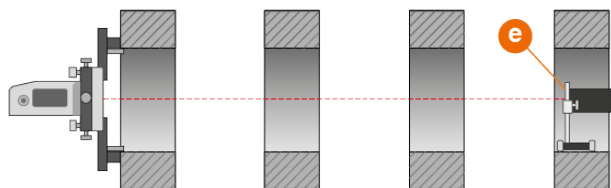

7. Angle the laser beam by using the micrometer adjustment screws [f] until the laser beam hits the center of detector target [g].

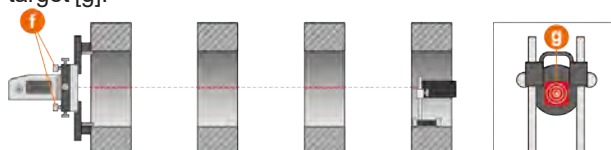

BORE CENTER

- Place the detector as close as possible to the laser transmitter. Open the detector target [h], so that the laser beam can hit the PSD.

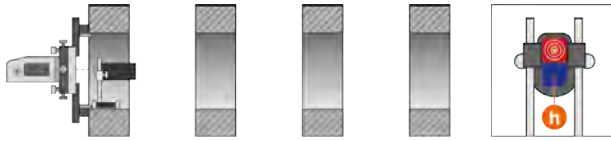

- In the Connect view , tap **0** to zero set the value.

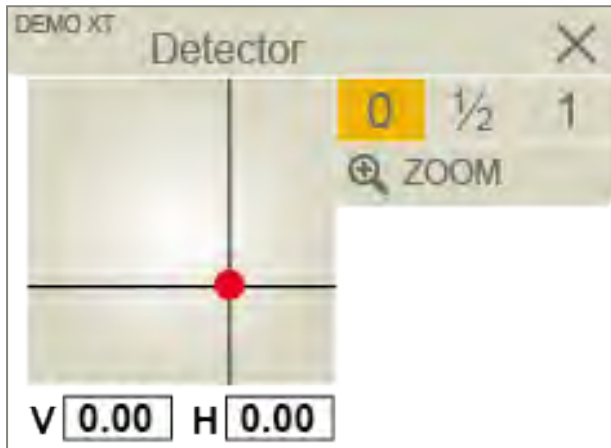

- Rotate the detector 180° [i] and tap $\frac{1}{2}$ to halve the value. Adjust the laser transmitter by using the offset hub adjustment screws [j] until the laser beam hits the **0** value [k].



- Move the detector to setup bore center position number 2 [l]. Angle the laser beam to **0** value by using the micrometer adjustment screws [m].

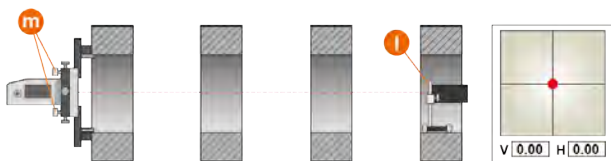

- It is recommended that you repeat steps 4-11 and fine adjust the setup bore positions. The laser beam must hit the center of both setup bore positions (within +/- 0,1 mm).

Measure with reference detector

When measuring, you can check the value from the reference detector by pressing the Device button. It is only possible to monitor the values from the reference sensor.

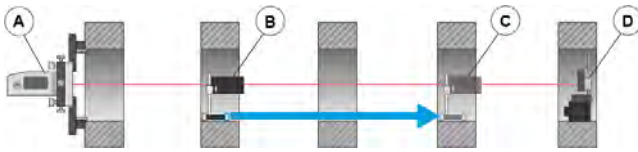

- A. Laser transmitter.
- B. M unit detector.
- C. M unit detector at farthest point to be measured.
- D. S unit used as reference detector during Measuring-procedure, placed beyond farthest point to be measured. Zero set and halve value when live device is zoomed in (remove M unit detector [C] when checking the reference detector).



- A. Tap to display Reference detector Live Device.
- B. Zero set and halve the value when Live Device is displayed. This does not affect the measurement.

An XT70-S can be used as reference detector. To set it to Reference mode, see below. When set to Reference mode the XT70-S display will show an "R". Other detectors that can be used as reference detectors are XT70-M and XT9. These detectors will not show an "R" when set to reference mode.



Display showing an "R" when XT70-S is set to Reference mode.

NOTE! The XT70-S unit will behave as an M unit when "Reference mode" is selected in the app, meaning M values are shown in the display. This is indicated by an "R". The XT70-S unit is automatically set to "Reference mode" during the entire measurement session. The XT70-S will go back to "normal mode" when disconnected from the app.

NOTE! "Reference mode" will automatically be switched off when you change program, for example to "Shaft".

Measure

1. Tap "Measure"  in the workflow, see *Measure view below*.
2. Place the detector in the bore position you want to start the measurement [a] and select the corresponding measurement position in the list, see *Measure view (position B) below*.

BORE CENTER

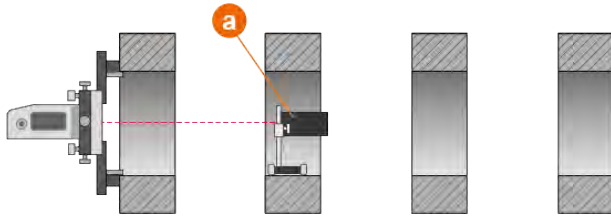

3. Tap  to register a measurement value, *see Measure view below*, rotate the detector and register a new value for each measurement point. Register a minimum of 3 measurement points. The program now calculates the vertical and horizontal value for the bore center position.



4. Measurement values are shown, *see Measure view below*.
5. Select next measurement position, *see Measure view below*, and move the detector to the corresponding bore position.
6. Repeat the measurement procedure in step 3 for every bore position.
7. To remeasure, select a registered bore position in the list and tap , *see Measure view below*.



Measure view.

- A. Measure icon is active in the workflow.
- B. Measurement positions. Check mark indicates that position is measured.
- C. Live reading of rotating detector.
- D. Tap to register measurement value for active measurement point.
- E. Registered measurement points.
- F. Registered measurement values.
- G. Minimum 3 registered measurement points (within at least a 60° span) required to get Bore center position values, V and H.
- H. Deviation: 4 registered measurement points are required to get deviation between optimal bore center point and registered bore center point.
- I. Tap to select filter for detector. See "Filter" on page 8
- J. Tap to delete highlighted point for the selected bore position.
- K. Tap to display Live Device.
- L. Zero set and halve the value when Live Device is displayed. This does not affect the measurement.
- M. Tap to open Roundness view, *see below*.

Roundness

Roundness is used to measure for example single bearings.

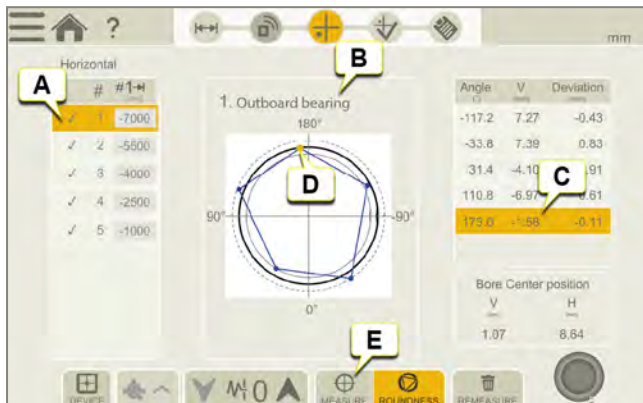

Roundness view.

- Selected bore position.
- Name of selected bore position.
- Selected measurement value.
- Corresponding measurement point is marked in the Roundness graph.
- Tap to return to Bore center Measure view.

NOTE! NOTE! Roundness is only applicable in Multi point measurement. Not applicable in 2-Point and 4-Point measurement.

2-Point measurement

2-Point measurement method (0 and 1/2) uses values in 2-axis for each recording. In horizontal mode the recording can be taken at 0° and 180° (+/- 2°).



2-Point measurement view.

- Tap to open 2-Point measurement view.
- Measurement position.
- Live reading of rotating detector.
- Tap to register measurement value for active measurement point.
- In horizontal mode the recording can be taken at 0° and 180° (+/- 2°).
- Registered measurement values.

BORE CENTER

- G. Tap to delete selected measurement point.
- H. Tap to display Live Device.
- I. Zero set and halve the value when Live Device is displayed.
This does not affect the measurement.

4-Point measurement

4-Point measurement method is a 1-axis measurement where recordings are taken in 0° , 90° , 180° and -90° ($\pm 2^\circ$). The vertical bore center position is calculated as the difference between top/bottom and horizontal bore center position is calculated as the difference between side/side.



4-Point measurement view.

- A. Tap to open 4-Point measurement view.
- B. Measurement position.
- C. Live reading of rotating detector.
- D. Tap to register measurement value for active measurement point.
- E. Recordings are taken in 0° , 90° , 180° and -90° ($\pm 2^\circ$).
- F. Registered measurement values.
- G. Tap to delete selected measurement point.
- H. Tap to display Live Device.
- I. Zero set and halve the value when Live Device is displayed.
This does not affect the measurement.

Manual entry measurement

Manual entry means that the operator enters the values for vertical and horizontal bore center positions. This allows the user to input a value even if the bore center is out of measuring range or using another type of measuring equipment, but wants to report, analyze and document straightness results using the XT-app.

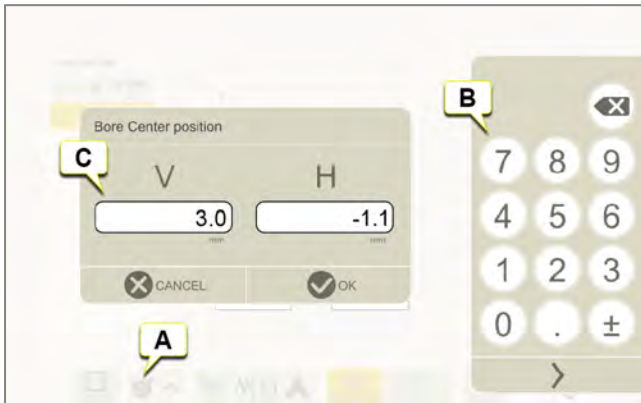

Manual entry measurement view.

- A. Tap to open Manual entry measurement view.
- B. Enter Measurement positions.
- C. Measurement positions are shown.

Vertical mode measurement

When vertical mode is activated the measuring positions for 2 point and 4-point method are shown as numbers and not according to an angle. In addition, there's no graphical guide for the detector positioning since the inclinometer is de-activated.

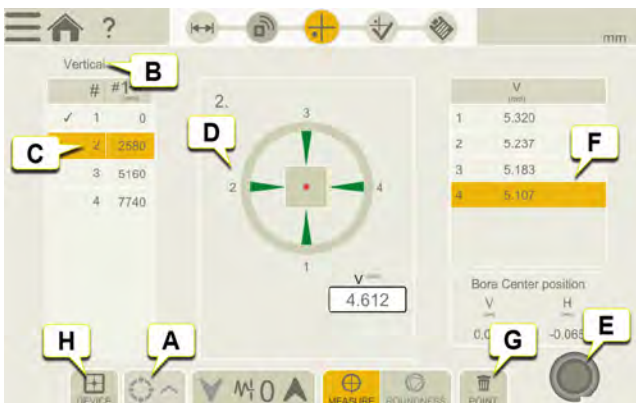

Vertical mode measurement view.

- A. Tap to open 4-Point measurement view.
- B. Vertical mode shown.
- C. Measurement position.
- D. Registered measurement points.
- E. Tap to register measurement value for active measurement point.
- F. Registered measurement values.
- G. Tap to delete selected measurement point.

Selection of measurement method is done for each measuring position and allows user to have different methods for measuring positions in the results.



Warnings during measurement

The following Warnings may appear in the Live Device information:



- A. Shake warning for laser transmitter. Deactivate by selecting Shake warning "OFF" in the XT app. If vibrations are strong enough to make the shake warning appear during measurement, increase the filter level of electronic levels from the XT app.
- B. Temperature warning for laser transmitter. Deactivate by selecting Temperature warning "OFF" in the XT app.
- C. No angular information is available. The electronic levels and inclinometers of the laser transmitter are out of range. Please position the transmitter closer to horizontal or vertical level.
- D. Device disconnected.
- E. Low battery warning. Charge the measuring device.

RESULT

Tap  in the workflow to display the Result view. Select table or graph to show the result. Different settings of the references can be made to present the measurement results directly in the Display unit before you move on to "Report". Tap  and  to finalize the measurement. The measurement is saved in the File manager.

NOTE! As long as you haven't finalized the result you can return to "Measure" and continue to register values.

Table view



#	Name	0-H	V	H	Ref	Data	V	H
1	Outboard bearing	2000	-0.45	-0.34		Min	-0.71	-0.47
						Max	1.56	0.44
						Peak-peak	2.27	0.91
4	Supp bearing 1	-2500	1.56	-0.44				
5	Supp bearing 2	-1000	-0.71	-0.47				

- A. Result icon is active in the workflow.
- B. Measurement positions, with names.
- C. Measurement distances.
- D. Measurement results.
- E. Reference point. To select reference point, first tap "Reference" in Reference modes [I].
- F. Green measurement result is within tolerance, red measurement result is outside tolerance.
- G. Statistics for the measurement data.
- H. Notes (visual in Report), reached via hamburger menu.
- I. Reference modes.
- J. Tolerances.
- K. Table view selected.
- L. Tap to open Roundness view.
- M. Select a point in the table.
- N. Corresponding point is marked in the Roundness graph.
- O. Out of Roundness values.

Graph view

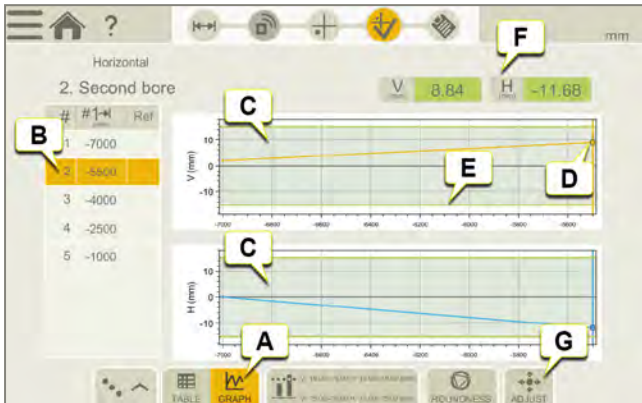

- A. Toggle between table and graph view.
- B. Selected measurement position.
- C. Graphs showing vertical and horizontal visual representation of the measurement results.
- D. Selected measurement position is highlighted in the graph.
- E. Green borders indicate set tolerances.
- F. Values for selected measurement position. Green color indicates within tolerance.
- G. Tap to open Adjust view. See "Adjust" on page 218



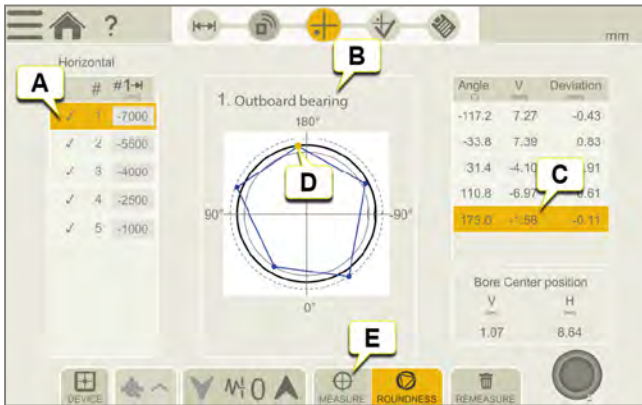



Roundness view



- A. Roundness view selected.
- B. Selected bore position.
- C. Out of Roundness values.
- D. Return to Table or Graph view.
- E. Tap to open Adjust view. See "Adjust" on page 218



Reference modes

When you perform a best fit calculation, the object is tilted to the lowest peak to peak value. It is fitted as straight as possible between two planes.

	Raw values.
	Zero. When you perform a best fit calculation, the measurement object is tilted to the lowest peak to peak value. It is fitted as flat as possible between two planes where the average value is zero.
	Negative. Best fit with all measurement points below 0. The reference line is moved to the highest measurement point.
	Positive. Best fit with all measurement points above 0. The reference line is moved to the lowest measurement point.
	Average. The reference line is moved to the average value of the measurement points.
	Set custom reference point.

ADJUST

In the Adjust view, live values and target are displayed to guide you through the adjustment procedure.

1. In Result view, tap  to adjust.
2. Select bore to be adjusted.
3. Adjust the bore to get the registered bore center point as close to the optimal bore center point as possible.
4. After adjusting you need to remeasure. Tap  to remeasure or tap  to view the report.

NOTE! Adjust is available when you have registered three measurement points on the current bore.

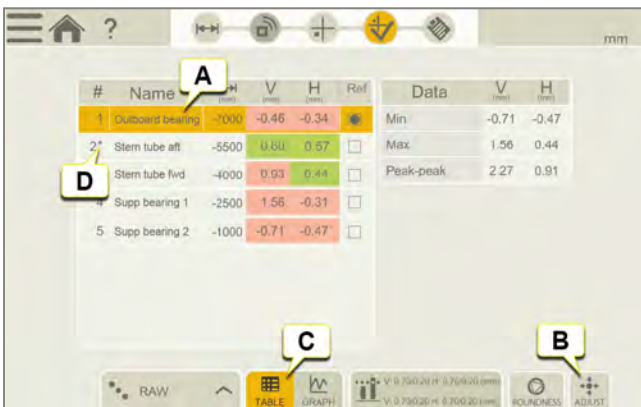

Result view.

- A. Bore to be adjusted (result out of tolerance).
- B. Tap to adjust.
- C. Possible to select Adjust from both table and graph view.
- D. Asterisk (*) indicates that the bore has been adjusted.



In the pop-up, the selected bore from the result page will be marked by default [A].

- A. In the pop-up, you can select optional bore to adjust. Place the detector in the selected bore and tap OK to open Adjust view.
- B. Close the pop-up if no adjustments are made.
- C. Values from Result. Live values are activated when adjustment is started.
- D. Detector must be placed at zero (± 2.0 degrees span) to start adjustment.
- E. Green indicates that detector is within the ± 2.0 degrees span.
- F. When button turns green, tap it to start adjustment.

- G. Adjust bore until cross-hair is in center.
- H. Return to Result view.



NOTE! The detector must be placed vertically within ± 2.0 degrees to activate adjustment and live values.

NOTE! After adjustment you need to remeasure. Go to Measure.

REPORT

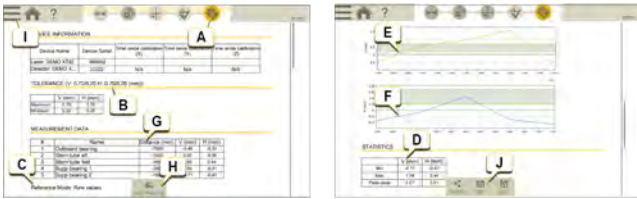
The report covers all details from the measurement. The report is constantly being filled out while the session is carried out. To see the report at its current state, tap  in the workflow.



- A. Report icon is active in the workflow.
- B. Tolerances.
- C. Reference mode.
- D. Statistics.
- E. Graph for V values.
- F. Graph for H values.
- G. Table with bore positions and measurement values, Vertical and Horizontal.
- H. Add photos (not applicable if you have finalized the measurement).
- I. Tap  and  to finalize the measurement. See "Finalize" on page 8
- J. Save as a PDF or Excel file. The files are saved in the File manager. The Share and Save functions are available after the measurement has been finalized.

Roundness view in REPORT

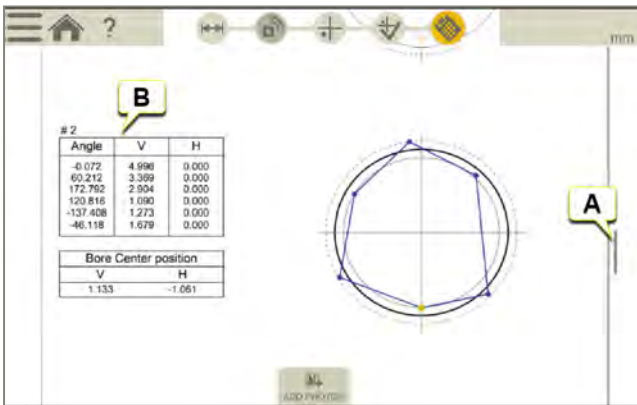

- A. Scroll down in Report to view Roundness.
- B. Roundness values.

For information on how to:

- Change the template
- Add a note
- Add a photo
- Change user information

- Save a report
- Share a report to USB

See "Report Overview" on page 14

BELT

OVERVIEW BELT

Easy-Laser® BTA system consists of a laser transmitter and a detector. Magnetic mountings on laser and detector make it easy to mount the equipment. Non-magnetic sheave/pulleys can be aligned as the units are very light and can be mounted using double-sided tape. All types of sheave/pulleys can be aligned, regardless of belt type. You can compensate for sheaves of varying widths.

For technical information, See "XT190 BTA" on page 321.



- A. Connector
- B. Detector aperture
- C. Battery Alkaline 1xR6 (AA) 1.5 V

Using the transmitter





- A. On/Off.
- B. Toggle between low power mode (laser beam flashes once) and high power mode (laser beam flashes twice).

NOTE! If not using the system for a long period of time, remove the battery from the laser transmitter.

Workflow Belt



The workflow on the top of the screen will guide you through your work. The current view is marked yellow. The report is constantly being filled out while the session is carried out. To see the report at its current state tap  in the workflow. The measurement is saved automatically through the entire workflow.

When you have finished the measurement, tap  and  to finalize it.



Prepare view is active in the workflow

Create a template

1. Tap  and .
2. Enter a new name or keep the default name. The template is saved in the File manager.

See "Templates for measurements" on page 12.

Belt types



- A. V-belt
- B. Flat belt
- C. Timing belt
- D. Chain drives

Offset and angular misalignment

The misalignment can be offset or angular. It can also be a combination of both.



- A. Offset
- B. Angular
- C. Both offset and angular misalignment.

PREPARE

- Check the sheaves for radial runout. Bent shafts will make it impossible to perform an accurate alignment.
- Check the sheaves for axial runout. If possible, adjust with the mounting screws of the bushings.
- Make sure that the sheaves are clean from grease and oil.
- The distance from the belt to the axial face of the sheave can be different on the two sheaves. See "Sheave width and diameter" on the next page.

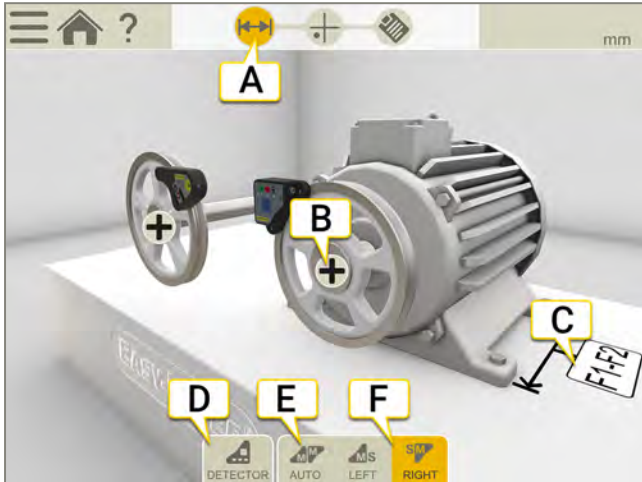

- The Prepare icon is active in the workflow.
- Tap to open machine properties. (Sheave width and tolerance.)
- Tap input field to enter distance.
- Tap to select detector.
- The Display unit automatically recognize where the units are placed.
- Set M-unit to the left or right.

Mount the units

The units are mounted on a flat machined surface with magnets. The magnets are very strong, try to soften the touch by putting just one magnet to sheave first, then turning the other ones in. Non-magnetic sheave/pulleys can be aligned as the units are very light and can be mounted using double-sided tape.

1. Mount the laser transmitter on the stationary machine.
2. Mount the detector on the movable machine.
3. Make sure all magnetic surfaces are in contact with the sheave.

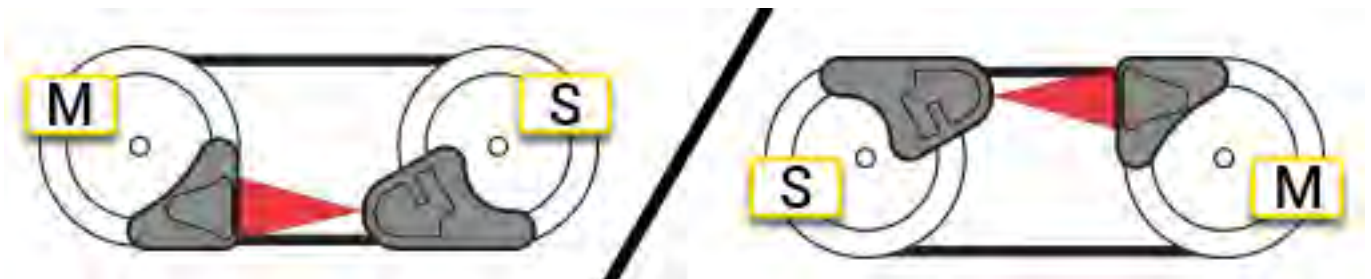

NOTE! All of the magnetic surfaces must be in contact with the object.

Sheave width and diameter

Enter sheave width in program

The distance from the belt to the axial face of the sheave can be different on the two sheaves. To calculate a possible offset the system requires **both** sheave face widths.

1. Tap **+** to open machine properties.
2. Measure the distance from the belt to the axial face of the sheave.
3. Enter the value.



Different sheave width without program

If the sheaves have different face widths, just add or subtract the difference from the zero value to get the value for perfect alignment.

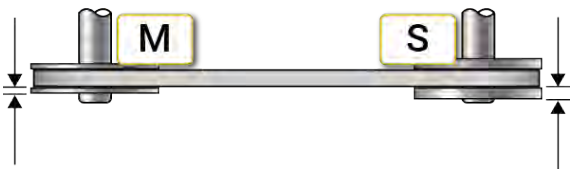

Sheaves with different face widths.

Sheave diameter

Tap \varnothing and enter sheave diameter. The diameter is visible in the report.

Belt Tolerance and RPM

1. Tap  to open machine properties.
2. Enter the value.

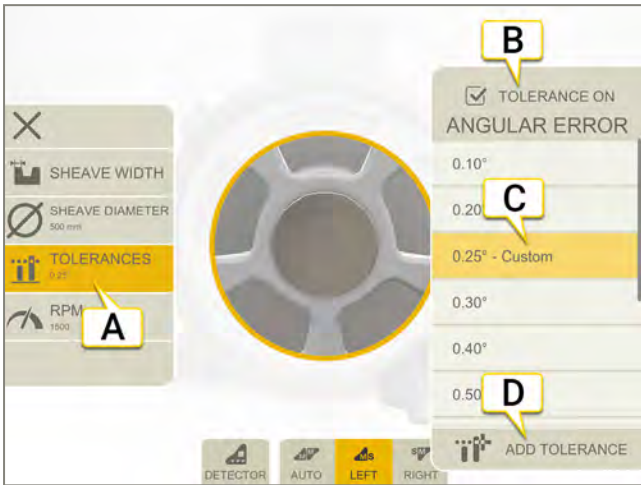

- A. Selected tolerance.
- B. Tap to select if you want to use a tolerance or not.
- C. Tap to select a tolerance.
- D. Add a custom tolerance.

Tolerance table

Recommended maximum tolerances from manufacturers of belt transmissions is 0.25–0.50°. Recommendations are always dependent on belt type. Please consult the design manual of the specific belt type.

\leq°	mm/m mils/inch
0.1°	1.75
0.2°	3.49
0.3°	5.24
0.4°	6.98
0.5°	8.73
0.6°	10.47
0.7°	12.22
0.8°	13.96
0.9°	15.71
1.0°	17.45

RPM

Tap  and enter RPM. It is visible in the report.

MEASURE WITH DISPLAY UNIT

Make sure that the laser line hits the detector aperture. The Display unit shows the offset and angular misalignment. The laser transmitter flashes when the battery is low. Change the batteries before you continue to measure. The E190 BTA can also be used as a separate tool. See "Measure without Display unit" on page 230.

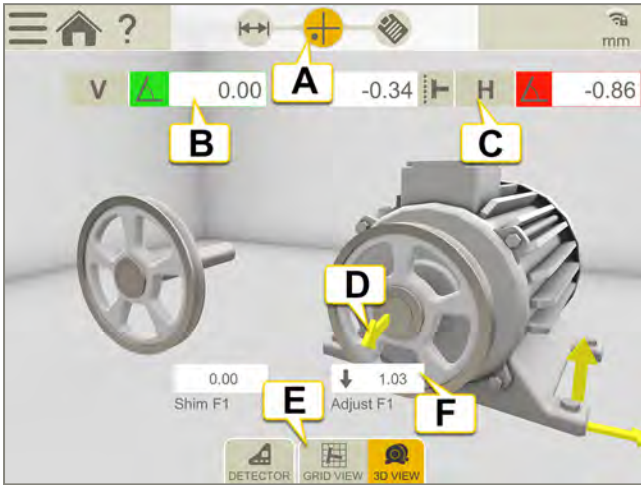

- A. The Measure icon is active in the workflow.
- B. Vertical angular error. To set tolerance, See "Belt Tolerance and RPM" on the previous page.
- C. Horizontal angular and offset error.
- D. Adjustment arrows show how to move the machine.
- E. Toggle between showing grid and machine view.
- F. Feet values.

Grid view

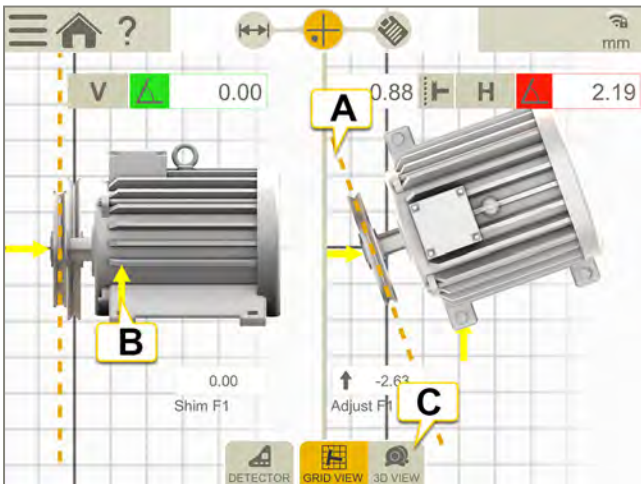

Tap  to show the grid view.



- A. The yellow line amplifies the offset and angle for an easier adjustment.
- B. Adjustment direction.
- C. Switch to 3D view.

Menu icons

Tap  to open the menu.

	Add a note to the report. See "Report Overview" on page 14.
	See "XT Display Unit Camera" on page 32
	Finalize the measurement. See "Finalize" on page 8.

Adjust

Start by adjusting the sheave, and then the machine.

- Correct offset by moving the movable machine with axial jackscrews, or by repositioning one of the sheaves on its shaft.
- Correct vertical angular error by shimming the movable machine.
- Correct horizontal angular error by adjusting the movable machine with lateral jackscrews.

When you adjust the machine one way, it often affects the machine's other alignment conditions. Which means this process may have to be repeated several times.

NOTE! If not using the system for a long period of time, remove the battery from the laser transmitter.

MEASURE WITHOUT DISPLAY UNIT

The XT190 BTA can be used as a separate tool.

Measure

To change between XT or E-system, see Settings below.

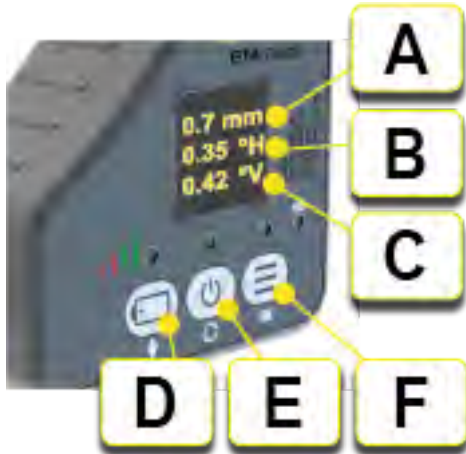

1. Press  to start the detector and ON to start the laser transmitter.
2. Read the values. Offset, horizontal angle and vertical angle are displayed.
3. Adjust machine, See "Measure with Display unit" on page 228.



- A. Offset (mm or inch)
- B. Horizontal angle
- C. Vertical angle
- D. Settings
- E. On/Off
- F. Battery

Settings

Press  to open the settings view. Use  to move up and down in the menu.

- Press  to switch position on the M and S-unit.
- Toggle between mm and inch with .
- Press  to select XT or E-system.

Different sheave width

See "Sheave width and diameter" on page 226.

Align with targets

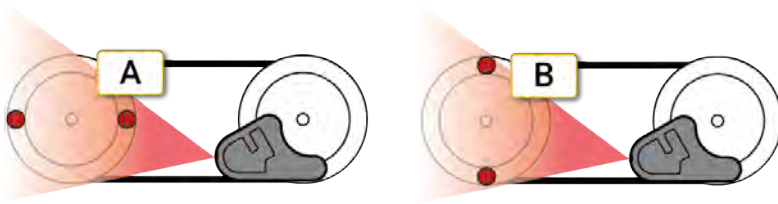

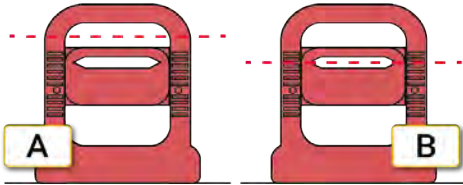

- A. Horizontal alignment
- B. Vertical alignment

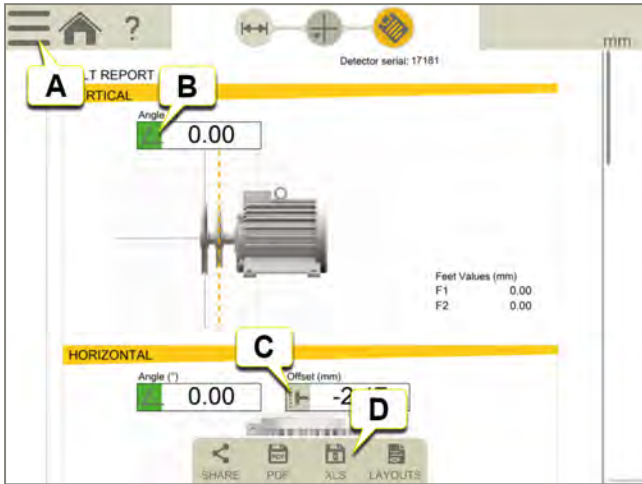

- A. Misaligned sheave
- B. Aligned sheave, the laser beam disappears in the slot of the target.

BELT REPORT



- A. Tap  and  to finalize the measurement. See "Finalize" on page 8
- B. Angle value. Green = within tolerance.
- C. Offset value.
- D. Save as a Pdf or Excel file. The files are saved in the File manager. The functions Share and Save as Pdf or Excel file are available after the measurement has been finalized.

For information on how to:

- Change the template
- Add a note
- Add a photo
- Change user information
- Save a report
- Share a report to USB

See " Report Overview" on page 14.

VIBRATION

OVERVIEW VIBRATION

Easy-Laser® XT280 is a simple to use vibration monitoring and analysis tool that allows easy display of vibration signals. The XT280 automatically performs vibration analysis functions based on machine running speed to help diagnose faults such as unbalance, misalignment and looseness. The system is designed to enable you to take vibration measurements from assets (e.g. pumps, motors, fans and bearings). The unit displays vibration frequency plots and allows vibration severity and bearing condition to be monitored.



- A. On/Off (🔌). It will automatically turn off if not used for 1 minute. Change the default setting in the Device settings. If the XT280 is connected to the Vibration program, the auto-off is disabled.
- B. Press (☰) to show Configuration menu.
- C. Press (📁) show Asset manager.

For information regarding technical data: See "XT280 VIB" on page 324.

Replace the batteries

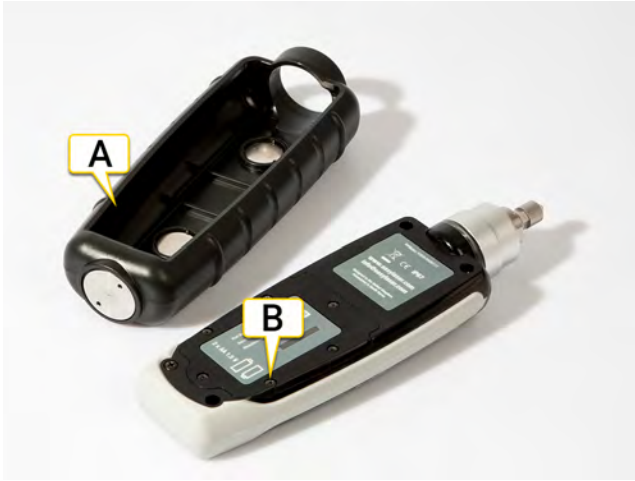

The XT280 uses two AA batteries.

1. Remove the protective cover (A).
2. Unscrew the battery cover (B) and replace the batteries. (Torx T9)



NOTE! If not using the system for a long period of time, remove the batteries.

CONFIGURATION

1. Press  to open the Configuration menu.
2. Move up and down in the menu using the arrow buttons.
3. Press  to select the highlighted item.

Left and right arrow buttons can be used to move backward and forward through the menus.



Live update

It is possible to have the XT280 continuously display readings that are taken at intervals of approx. 1 second. It is possible to use live update with the basic readings screen, the VA bands screen or 100 line frequency spectrum.

Press  to register a value at any time during live update. A full (800 line) resolution reading is registered.

NOTE! Live values are not displayed in the Vibration program.

Setup Wizard

Selecting the Setup Wizard opens a dialogue that allows the machine running speed to be entered and the ISO alarm levels to be set automatically according to the size and type of machine to be monitored.

Run speed

The first Setup Wizard screen shows the currently selected running speed in the pre-selected units (Hz or RPM).

1. Press the up arrow button (to increase run speed) or down arrow button (to decrease run speed).
2. Press  to confirm. Machine type settings is displayed.

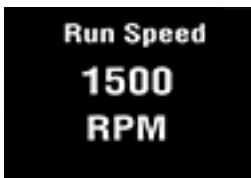

Machine type

The second Setup Wizard screen allows you to select machine type (motor or pump)

- If a **motor** is selected the size must be selected (under or over 300kW).
- If a **pump** is selected, it must be specified whether it has an integrated or external drive unit.

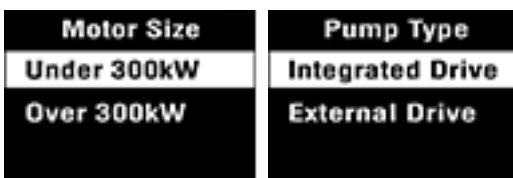

Selecting the machine type and size allows the ISO alarm levels to be set accordingly, as does specifying the type of mounting (rigid or flexible). As a basic “rule of thumb”, unless a machine is bolted down to a concrete floor, its mounting should be considered as being flexible. Most motors and pumps are mounted on some kind of frame or structure and as such should definitely be considered as flexibly mounted.

Manual setup

Velocity settings

1. Select Velocity alarms.
2. Set the alarm levels at which the velocity readings change color. Normal levels are displayed on a green background.
3. Press arrow left to go back to Manual setup.
 - **Warning.** Yellow readings, default is set to 4.5 mm/s. Use up and down arrows to change the setting.
 - **Critical.** Red readings, default is set to 7.10 mm/s. Use up and down arrows to change the setting.

BDU alarm settings

1. Select BDU alarms.
2. Set the alarm levels at which the BDU readings change color. Normal levels are displayed on a green background.
3. Press arrow left to go back to Manual setup.
 - **Warning.** Yellow readings, default is set to 50. Use up and down arrows to change the setting.
 - **Critical.** Red readings, default is set to 100. Use up and down arrows to change the setting.

These levels are typical for medium sized machine bearings operating at run speeds in the region of 1000 to 3000 RPM. Larger bearings or higher run speeds may need increased BDU threshold values to identify worn or bad bearings.

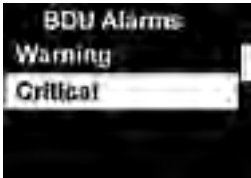

Run Speed

1. Select Run speed.
2. Select a run speed using the up and down arrow buttons.
3. Press arrow left to go back to Manual setup.

Device settings

Use the down arrow button to see all device settings. Pressing  to select a setting. Press arrow left to return to the previous menu.

Auto Off Time

From 1 minute up to 60 minutes. If the XT280 is connected to the Vibration program, it will not turn off.

Brightness

- Mode. Select Standard or High
- Level. Set anywhere between 1 (least brightness) up to 10 (full brightness).
- Auto Dim Time. Set the time using the up and down arrows.

Language

Only English is available.

Factory reset

Select to return to the default settings. Select to return to metric or imperial default settings.

Graph Mode

Set to display the frequency spectrum as either a Line graph or a Bar graph.

color Scheme

Configured as standard (full color) or monochrome, e.g. for convenient viewing in direct sunlight.
You need to restart the XT280 to see the change of color scheme.

Time & Date

Setting can be achieved using the up, down, left and right arrow buttons



Units

- Velocity. Select mm/s or inch/s.
- Run speed. Select Hertz (Hz), revolutions per minute (RPM) or cycles per minute (CPM).
- Velocity type. Select RMS or Peak.
- Displacement. Select Peak (Pk) or Peak to peak (Pk-Pk).

Information

Version number, serial number and Mac ID.

MEASURE WITH DISPLAY UNIT

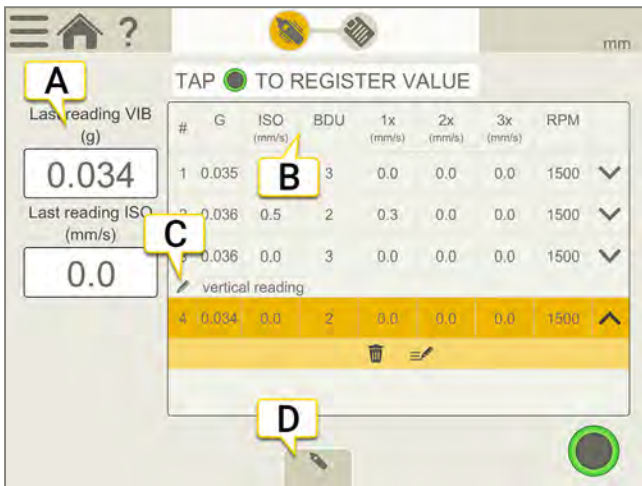

1. Press  to start the XT280.
2. Set the appropriate configurations in the XT280 menus. See "Configuration" on page 235.
3. Place the XT280 on a rigid part of the machine as close as possible to the desired measurement point (e.g. bearing block) using the magnet mount.
4. Tap  to connect to an XT280 device.
5. Tap  to register values. Either on the XT280, or on the Display unit. It will take 3-5 seconds to register a value.



- A. The latest readings are displayed here.
- B. For information regarding these values See "Result" on page 241.
- C. It is possible to add a note to a measurement point.
- D. Tap to select a XT280 device.





Workflow Vibration

The workflow on the top of the screen will guide you through your work. The current view is marked yellow. The report is constantly being filled out while the session is carried out. To see the report at its current state tap  in the workflow. The measurement is saved automatically through the entire workflow.

When you have finished the measurement, tap  and  to finalize it.

Add a note

Notes are also visible in the report.

- Select  and  if you want to add a note for the **whole** measurement.
- Tap  on a value and then  to add a note for the selected value.

VIBRATION REPORT

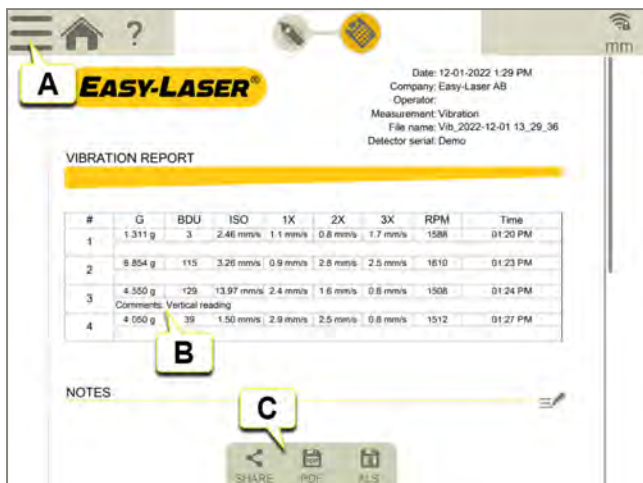

- Tap and to finalize the measurement. See "Finalize" on page 8
- The comments are visible in the report.
- Save as a Pdf or Excel file. The files are saved in the File manager. The functions Share and Save as Pdf or Excel file are available after the measurement has been finalized.

For information on how to:



- Add a note
- Add a photo
- Change user information
- Save a report
- Share a report to USB

See " Report Overview" on page 14.

MEASURE WITHOUT DISPLAY UNIT

The XT280 can be used as a separate tool.

Measure

1. Press  to start the XT280.
2. Set the appropriate configurations in the XT280 menus. See "Configuration" on page 235.
3. Place the XT280 on a rigid part of the machine as close as possible to the desired measurement point (e.g. bearing block) using the magnet mount.
4. Press  to register a value. It will take 3-5 seconds to register a value.

For more information See "Result" on the facing page.

RESULT



Three values are displayed. The Velocity and BDU values are color coded to show their alarm status.

- Velocity. RMS or Peak (shown in mm/second or inch/s)
- Bearing Noise in BDU (Bearing Damage Units)
- Total g (acceleration)

See "Vibration analysis" on page 243.

RMS value

The ISO value (in mm/s or inch/s) is the RMS (average) of the vibration velocity in the frequency band 10Hz (600 RPM) to 1kHz (60,000 RPM) or 2Hz (120 RPM) to 1kHz (60,000 RPM), as specified by the ISO standard. The correct frequency band is automatically selected by the XT280 based on running speed. The background is color coded according to the ISO 10816-1 vibration velocity level chart (see below). The color coded background indicates the condition of the machine according to the size and type of machine selected. See "Configuration" on page 235.

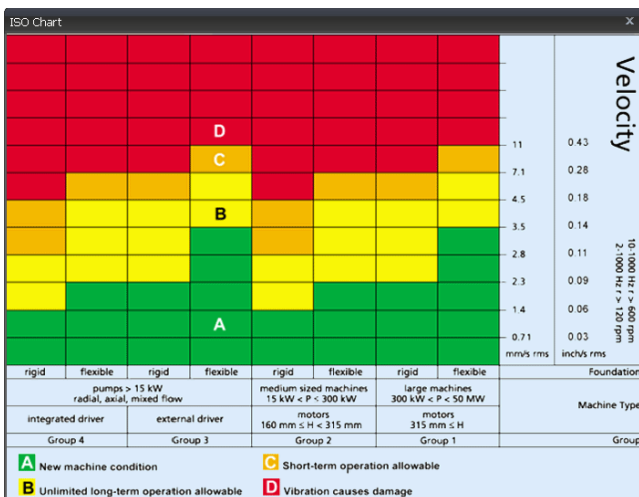

ISO 10816-1:1995. Mechanical vibration - Evaluation of machine vibration by measurements on non-rotating parts.

Bearing Noise (BDU)

Bearing noise (high frequency vibration) in Bearing Damage Units (BDU), where 100 BDU corresponds to 1g RMS (average) vibration measured above 1kHz. This is a measure of the wear state of the bearings in the equipment being monitored. The higher the number, the more worn the bearing.

It is commonly held that 1g of high frequency vibration (100 BDU) corresponds to a relatively high level of bearing noise and so can be considered indicative of a damaged bearing. In other words, it may be helpful to think of the Bearing Noise figure as being very roughly equivalent to "percentage" of bearing wear.

By default, the bearing noise is displayed on a

- Red background if it is above 100 BDU
- Amber background between 50 and 100 BDU
- Green background below 50 BDU.

The BDU alarm levels can be changed. See "Configuration" on page 235.

Total acceleration (g)

This is the RMS (average) value of the total vibration acceleration measured by the meter over its entire frequency range (2Hz to 10kHz). This reading is shown in units of g (Earth's gravitational constant, where $1g = 9.81 \text{ m/s}^2$).

RMS displacement

Press the left (<) or right (>) arrow button when the reading screen is displayed will display RMS displacement (in μm or mils) on a blue background. Press either arrow button again will revert to display of the ISO value (mm/s or inch/s).

VIBRATION ANALYSIS

Press the down arrow to display the readings of vibration velocity (mm/s or inch/s), or displacement (μm or mils) if selected, broken down into each of 3 bands.

The display shows the vibration level in frequency ranges that are all based on multiples (1X, 2X and 3X) of the specified Run Speed of the machine as displayed beneath the 3 bar graphs.

In order to perform a vibration analysis it is important that the running speed of the machine is entered correctly. This can be done with the Setup Wizard. See "Configuration" on page 235.



The frequency ranges of the VA bands are based on the following multiples of running speed:

1X = Unbalance

The level of vibration in the frequency band based on the running speed is usually indicative of how well balanced the machine is. A large vibration at the running speed usually indicates that the machine is out of balance. However even a very well balanced machine will typically show some vibration at the running speed but this figure should ideally be quite low (e.g. typically less than about 2 mm/sec for a medium sized machine).

2X = Misalignment

A high level of vibration in the frequency band centered at twice the running speed is a possible indication of misalignment. This is based on the fact that shaft misalignment can result in a double peak in the waveform due to there being two different centers of gravity (one from each shaft). In other words the accelerometer picks up a peak as each center of gravity passes by and hence there will be two positive and two negative peaks each revolution of the shaft. This will typically give rise to a vibration signal at double the running speed of the machine.

3X = Looseness:

High vibration in the frequency band centered at 3 times running speed is a possible indication that something may be loose (e.g. loose mounting bolts, weak foundations etc.) as it is not usual to see third order vibration in a machine unless there is some structural looseness that is being "excited" by the vibration of the machine.



FREQUENCY SPECTRUM

Press the down arrow button once more to display vibration levels shown as a frequency spectrum in the range from 0 to 1kHz. The heights of the peaks indicate the RMS vibration level (in mm/s or inch/s) at each frequency point in the spectrum. The readings to the right of the screen show the frequency (in Hz or CPM) and the RMS vibration level (in mm/s or inch/s) at the position of the cursor (red dotted line). The cursor position can be moved by use of the left (<) and right (>) arrow buttons.



Pressing the down arrow button increases the resolution of the frequency axis from 100 Lines (i.e. 10Hz or 600 RPM resolution) to 800 Lines (i.e. 1.25Hz or 75 RPM resolution). Increasing the resolution effectively zooms into the frequency spectrum. In order to display the full spectrum at the higher resolution the display must be scrolled using the left and right arrow buttons.

ASSET MANAGEMENT

1. Press  to open the Asset Manager, the Machines menu is displayed (four machines).
2. Scroll the list with the up and down arrow buttons.
3. Press  to select a machine. This brings up a list of measurement points for that machine.

Measurement point

Each machine can have up to 10 VibPoints.

1. Scroll the list of measurement points by using the up and down arrow buttons.
2. Press  to select a VibPoint. The various options for each VibPoint are displayed.
 - Take Reading – takes a new reading and saves it to this VibPoint.
 - Run Speed – set the run speed.
 - Save Reading – saves the previously taken reading to this VibPoint.
 - Load Reading – loads a saved reading (e.g. for re-display)





PRECISION LEVEL

OVERVIEW XT290

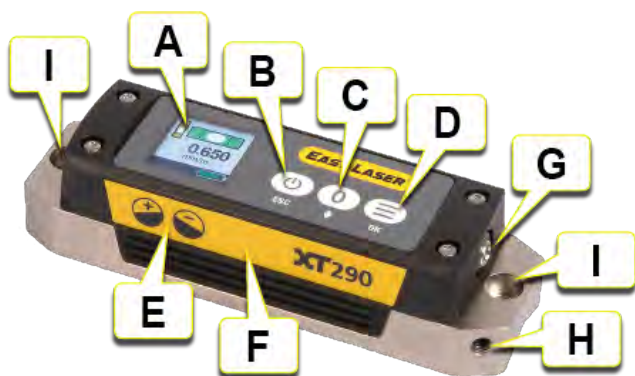
Digital Precision Level XT290 for setting-up and aligning most types of machine, for example levelling machine tables, rolls, bases etc. Other areas of use include straightness, flatness and parallelism.

The Precision Level XT290 can be wirelessly connected to your Easy-Laser® XT alignment app. See "Measure with Display unit" on page 257



- A. Measuring display.
- B.  On/Off and to return from menu to measuring mode ("ESC").
- C.  to zero set value and  to toggle in menus.
- D.  to access menus and for "OK".
- E. Symbols explaining positive (+) or negative (-) value according to the tilt angle of the XT290.
- F. Yellow label helps you to keep track of measuring direction of the XT290.
- G. Power adapter charging port.
- H. Threaded hole for safety strap.
- I. Holes for mounting accessories/personal adaption.

For information regarding technical data: See "XT290 Technical data" on page 308

NOTE! For correct values (positive and negative), always keep the yellow label in the same direction in the different measurement positions.

PRECISION LEVEL

Charge XT290

Charge XT290 by plugging in the power adapter. It is possible to keep on using the XT290 while it is charging, see *NOTE below*.

Charging temperature: 0 to +40 °C [32 to 104 °F] (temperature inside the unit).

NOTE! For best measurement accuracy it is recommended not to charge the XT290 when measuring, due to the generated heat.

NOTE! If you need to change the XT290 battery, please contact your Easy-Laser Distributor.

XT290 settings

Press  to access settings in the Main menu.

NOTE! For the most accurate measurement result, the XT290 must be level calibrated and temperature adapted for the environment it is supposed to operate in.

NOTE! All settings, except temperature and zero point set with the Zero button, are saved even when the XT290 is turned off.

NOTE! When XT290 is connected to the XT app, the settings for "Unit", "Resolution" and "Filter" can only be made in the XT app. When connected to the XT app, these display menus are disabled in XT290 and "Factory reset" is completely disabled.

NOTE! When settings are changed in the XT app during connection, the app settings apply to the XT290. When disconnected, the XT290 settings return to the settings made before the connection.



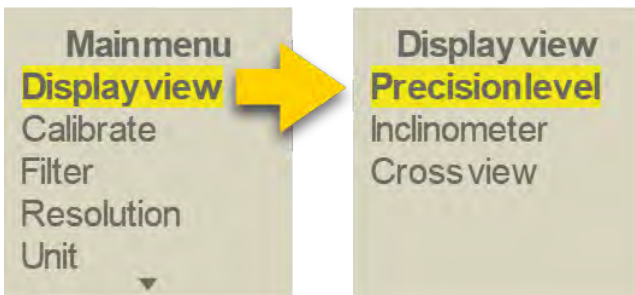

Display view

Press  and select "Display view". Choose from "Precision level" view for precision level & low accuracy inclinometer (roll), "Inclinometer" view for low accuracy inclinometer (pitch & roll) and "Cross view" for low accuracy inclinometer (pitch & roll).



Level Calibration

The XT290 is factory calibrated. To calibrate on site:

1. Place the XT290 on the object to be measured (on a cleaned surface!). Make a mark to ensure that you place the XT290 in the same position
2. Press  and select "Calibrate". Wait until the value has stabilized. Press  for OK.
3. Rotate the XT290 180°. Wait until the value has stabilized. Press  for OK.
4. Press . The XT290 is now calibrated. The calibration is saved even when the XT290 is turned off.
5. Rotate the XT290 180°, back to the original position. Now you can start measuring.

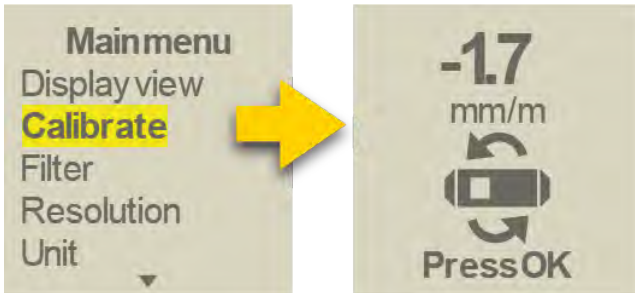

Filter

Press  and select "Filter". Choose from "Low", "Medium" or "High" filtering time of measurement value.





Resolution (number of decimals)

Press  and select "Resolution". Choose from "Low", "Medium" or "High".



Unit (angular)

Press  and select "Unit". Choose from the following angular units:

mm/m, mils/inch, inch/foot, degrees or arc sec. Use  to toggle the menu.

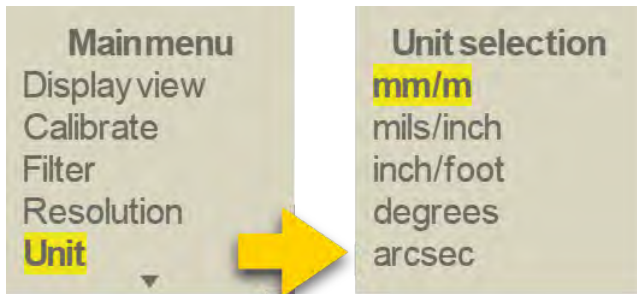

Shake warning

Press  and select "Warnings" > "Shake warning". Choose on or off in the checkbox. Shake warning automatically disappears when shaking stops. If vibrations are too strong so that the shake warning appears during measurement, it is recommended to increase the filter level setting.

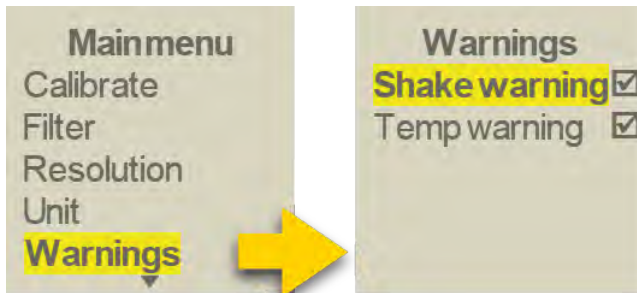

PRECISION LEVEL

Temperature warning

If the temperature warning appears during measurement, clear it by pressing  if you want to continue measuring.

See note below.

Press  again and select "Warnings" > "Temp warning". Choose on or off in the checkbox.

For temperature information, see Main menu > System info > Temp

The temperature sensor is located inside the XT290, on the precision level PCB.

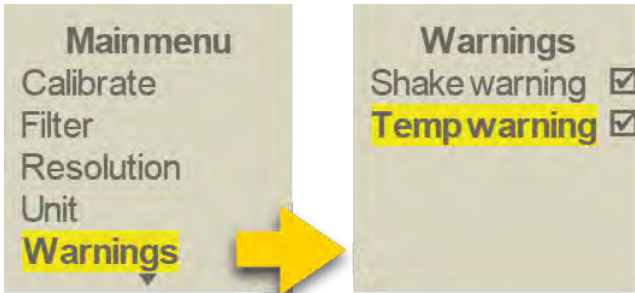

NOTE!

The temperature warning will appear if the internal temperature of the precision level changes too rapidly. This can reduce the quality of the measurement. Always let the precision level warm up before starting the measurement, and make sure ambient temperature is stable.

Factory reset

Press  and select "Factory reset" to return to factory settings (as when the XT290 was delivered).

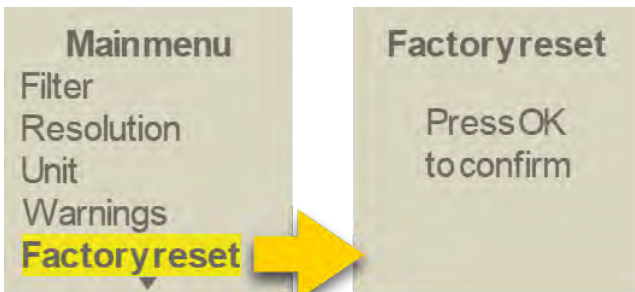

System info

Press  and select "System info" for information about serial number, firmware version, BGM (wireless) version, part no and internal temperature of the XT290.

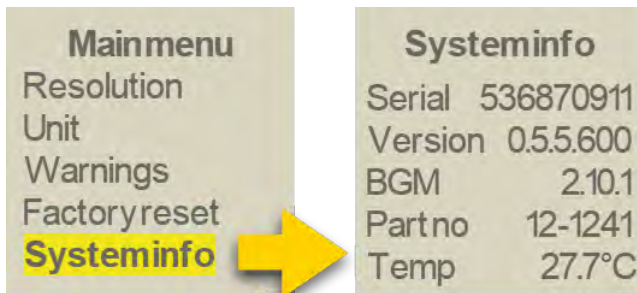

MEASURE

1. Clean the surface where the XT290 will be placed.
2. Place the XT290 on the object to be measured and press  to start.
3. Read measuring value when it has stabilized.
If XT290 has the right working temperature the values can usually be used immediately but Level Calibration on site is recommended. See "Overview XT290" on page 247





NOTE! To reach full accuracy, make sure that the temperature of XT290 has stabilized in the measurement environment.

NOTE! For correct values (positive and negative), always keep the yellow label in the same direction in the different measurement positions.

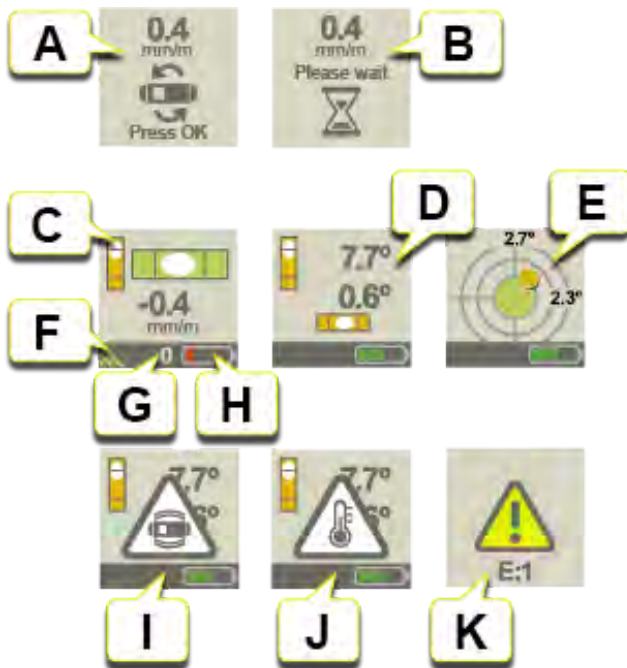
XT290 Display views



- A. Level Calibration: Turn XT290 around 180° and press OK. See "Overview XT290" on page 247
- B. Level Calibration: Wait until the calibration step has finished.
- C. Measuring view: Values within high accuracy measurement range are presented in mm/m [mils/inch], up to ± 20 mm/m [mils/inch].
- D. Measuring view: Values are presented in degrees, up to $\pm 180^\circ$.
- E. Measuring view: "Cross view". Values are presented in degrees, up to $\pm 180^\circ$.
- F. Wireless XT app connection (applies when measuring with Display unit). See "Measure with Display unit" on page 257
- G. Value is zero set.
- H. Battery status. If necessary, charge the XT290. See "Overview XT290" on page 247.
- I. Shake warning. Disappears when shaking stops. See "Overview XT290" on page 247
- J. Temperature warning. Press  to clear. Press  for temperature information in the menu. See "Overview XT290" on page 247
- K. No access to device, error code E1. The unit must be sent for repair.

PRECISION LEVEL

Explanation of X and Y values

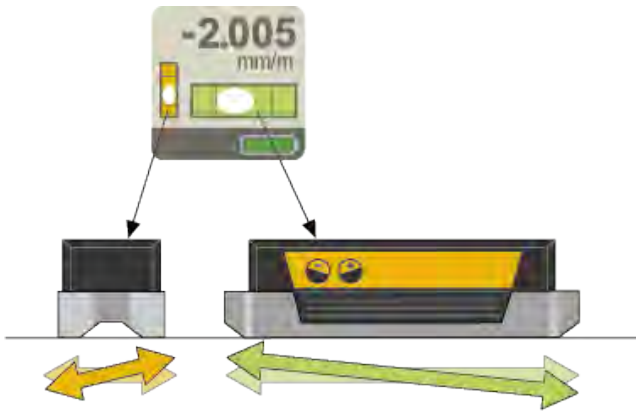

The precision level (green) is measuring the X (pitch) direction with high accuracy. Outside high accuracy range, it will switch to inclinometer (orange).

The inclinometer (orange) is measuring the Y (roll) direction with low accuracy (and works as a guide to ensure that the XT290 is correctly placed on the object to be measured).

Measure with two XT290

You can measure with two XT290 simultaneously when there is a need for high accuracy measuring in two directions, for example on a milling machine.



MEASURE WITH DISPLAY UNIT

The Digital Precision Level XT290 can be wirelessly connected to your Easy-Laser® XT alignment app and you can read the XT290 values in the "Values" program. See "Connect" on page 53



In the XT app you can read 1, 2, 3 or 4 devices simultaneously. See "Connect" on page 53

NOTE! When XT290 is connected to the XT app, the settings for "Unit", "Resolution" and "Filter" can only be made in the XT app. When connected to the XT app, these display menus are disabled in XT290 and "Factory reset" is completely disabled.

NOTE! When settings are changed in the XT app during connection, the app settings apply to the XT290. When disconnected, the XT290 settings return to the settings made before the connection.

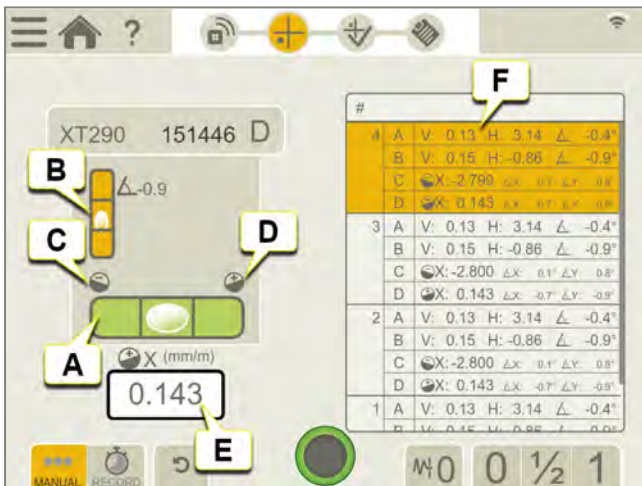
1. Clean the surface where the XT290 will be placed.
2. Place the XT290 on the object to be measured and press  to start.
3. Read measuring value when it has stabilized.
If XT290 has the right working temperature the values can usually be used immediately but Level Calibration on site is recommended. See "Overview XT290" on page 247
4. Connect the XT290 to "Values" program. See "Connect" on page 53
5. Tap  to register values in "Values" program. See "Measure" on page 55
6. View Report in "Values" program. See "Report" on page 64



- A. Precision level shows X (pitch) direction. Value is presented in mm/m (mils/inch).
- B. Inclinometer shows Y (roll) direction. Value is presented in degrees.
- C.  Bubble towards this icon indicates negative measurement value and that the surface has a downward slope to the right.*
- D.  Bubble towards this icon indicates positive measurement value and that the surface has a downward slope to the left.*
- E. Latest reading.
- F. Registered values (precision level X/pitch value, inclinometer X/pitch value, inclinometer Y/roll value).
- G. Delete value.
- H. It is possible to add a note to a registered value.

* when viewing XT290 from yellow label side.

Read up to four devices simultaneously

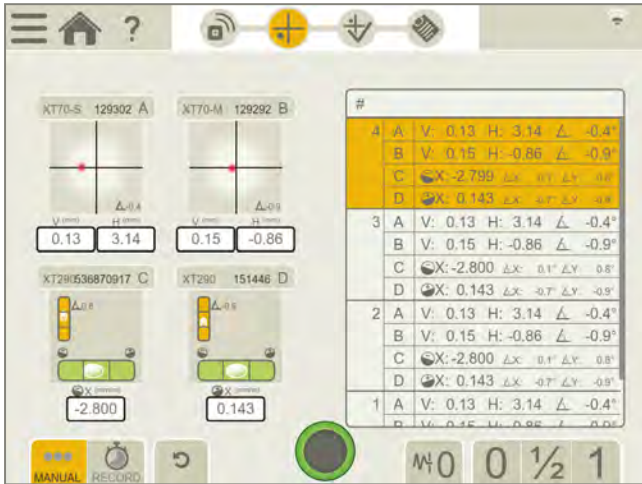

In the "Values" program in the XT alignment app you can read up to four XT290 simultaneously. Normally you have practical use of one or two XT290 but they can be combined with other types of measuring units. See "Connect" on page 53



Warnings during measurement

The following Warnings may appear in the "Values" angular visual representation.



- A. Shake warning. Disappears when shaking stops.
If vibrations are strong enough to make the shake warning appear during measurement, increase the filter level.
- B. Temperature warning. Press  to clear. Press  again for temperature info in XT290 Settings menu.
- C. Low battery warning. Charge the XT290. See "Overview XT290" on page 247.

LASER TRANSMITTERS

LASER TRANSMITTER XT20/XT22



Laser transmitters XT20 and XT22 with digital display and electronic levels.

XT20 and XT22 can be used with XT programs Straightness and Values.

The XT22 also has an extra vertical level and built in reversible angular prism which makes it useable for all kinds of geometrical measurements.

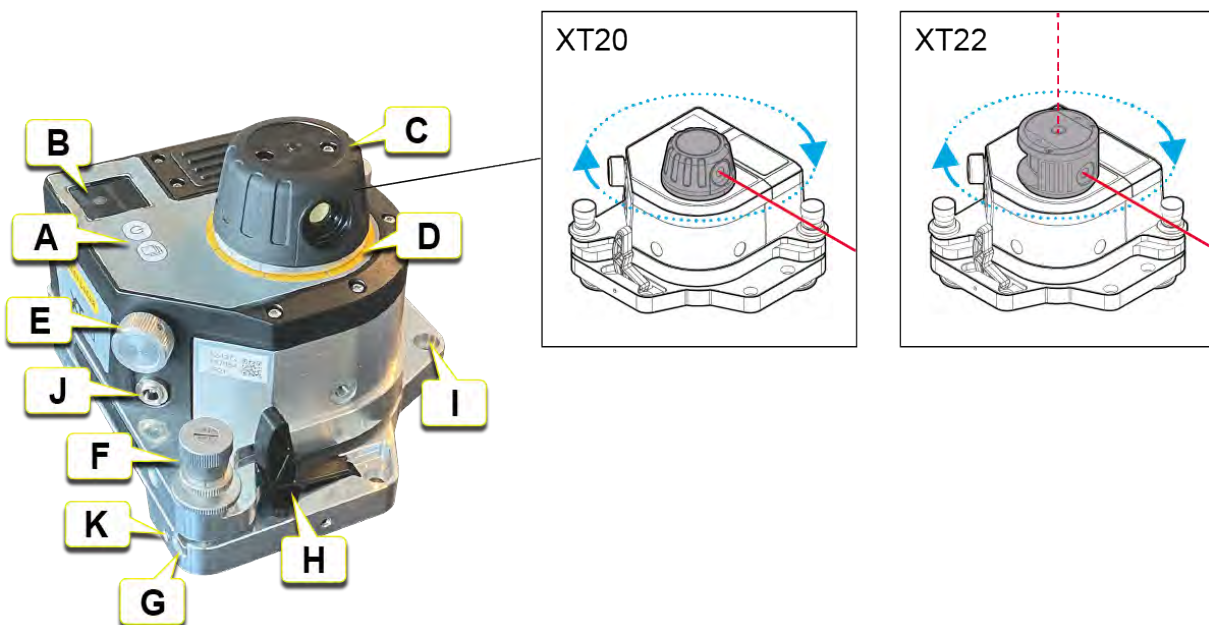
The XT20 and XT22 can be wirelessly connected to your Easy-Laser® XT alignment app.



- A.  On/Off,  Change Display view.
- B. Measuring display.
- C. Laser head (with reversible angular prism for XT22) that can be rotated by hand.
- D. Marking for every 45°, for quick rough alignment.
- E. Fine adjustment.
- F. Tilt screw (x2).
- G. Tilt table.
- H. Release lever. Also for dampening magnet force when placed on the surface.
- I. Fastening of magnet base.
- J. Power adapter charging port.
- K. Threaded M6 hole (x4) for safety strap and other accessories/adaptations.

Safety strap

Use an approved safety strap to prevent equipment from falling and causing injuries. Choose a safety strap that has been approved for the weight it should carry, and for the circumstances under which it will be used. Always follow your company's internal rules for safe work. The safety strap should be connected to the equipment using the M6 screw provided (part. no 01-1402). Check the strap for damages and wear regularly. If it has been involved in a sharp drop, please replace it. Fasten the strap **above** the equipment.

Tilting screws

The tilting screws on the levelling table of the laser transmitter have to be operated carefully and according to instructions.

Visual rough alignment to (detector) target

Check the position of the fine adjustment screw. It should be in its nominal position approx. 2.5 mm.

1. Loosen the locking screw.
2. Adjust with the course screw to wanted position.
3. Tighten the locking screw.

Digital fine adjustment to detector and read values

1. Check so that the locking screw is tightened.
2. Adjust with the fine adjustment screw to wanted value.

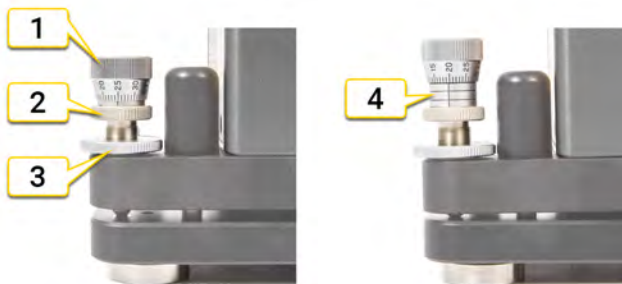

1. Fine adjustment screw
2. Coarse screw
3. Locking screw
4. Maximum position

Charge XT20/XT22

Charge XT20/XT22 by plugging in the power adapter. It is possible to keep on using the XT20/XT22 while it is charging, see *NOTE* below.



Display view when charging.

Charging temperature, See "XT20/XT22 Technical data " on page 294

NOTE! If the laser transmitter is charged when "ON", the charging time will be longer to reduce heat generation that can affect measurement stability. For best measurement stability and shortest possible charging time, it is recommended to charge the XT20/XT22 when "OFF".

Setting of angular unit for Laser Transmitter XT20 and XT22

Tap the Live Device View to open Context menu and tap "RESOLUTION". Set angular unit and resolution (number of decimals) for XT20/XT22. The angular unit and resolution in the XT20/XT22 measuring display will be the same as the settings in the app.

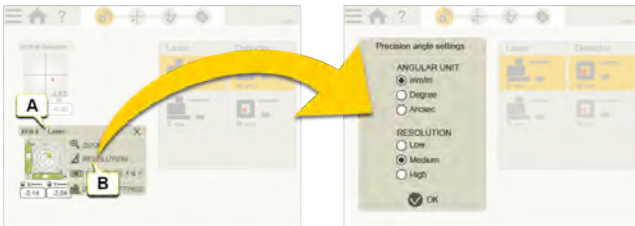

- A. Tap the Live Device View to open Context menu.
- B. Tap to set angular unit and resolution.

Settings for XT20 and XT22

Tap the Live Device View to open Context menu and tap "SETTINGS". Set Display view, Filter level and activation/deactivation of Shake warning and Temperature warning.

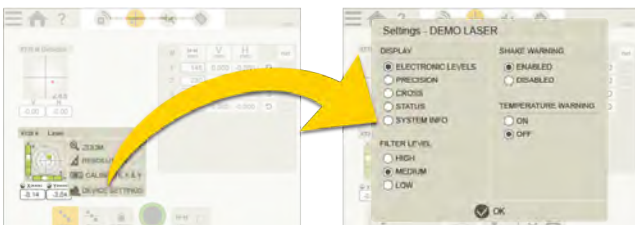

NOTE! You can only select filter when the XT20/XT22 is connected to the XT app. "Low" filter level is default when not connected.

Calibration of Laser Transmitter XT20 and XT22

Tap the Live Device View to open Context menu and tap "CALIBRATE". Calibrate XT20/XT22 electronic levels horizontally by following the Calibration guide in the app.

See "Calibrate XT20/XT22 electronic levels horizontally" on page 266

See "Calibrate XT22 electronic level vertically" on page 269



- A. Tap the Live Device View to open Context menu.
- B. Tap to calibrate laser transmitter.

NOTE! If you want to use electronic levels, these must be calibrated before you start measuring.

USING THE XT20/XT22

XT20 and XT22 can be wirelessly connected to your Easy-Laser® XT alignment app for the programs Straightness and Values. To see example of Set up and Measuring procedure, See "Measure" on page 194

NOTE! If you want to use the vertical electronic level in XT22 when orienting the laser plane vertically, the laser transmitter must be mounted with the XT22 product label facing upwards. See image below.

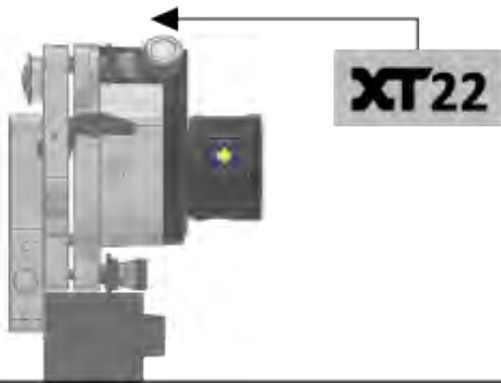

Vertical mounting of XT22.

Laser transmitter mounting

In addition to placing the laser transmitter directly on the object to be measured, it can be mounted on magnet bases. The Multi bracket 12-1275 provides even more versatile mounting possibilities, see examples below.

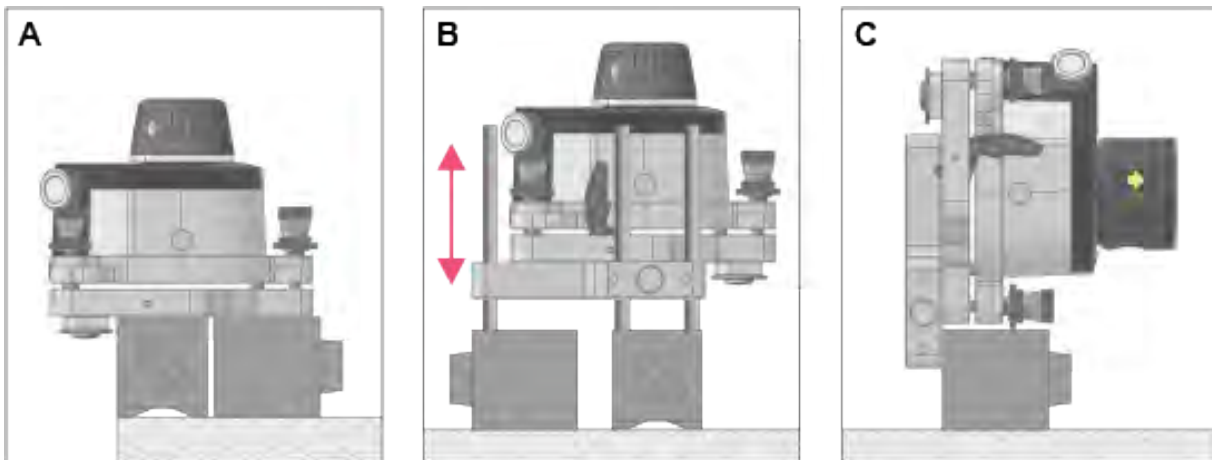

- A. Mount one or two magnet bases directly on the tilt table. Release lever must first be removed.
- B. Use Multi bracket and rods on magnet bases to position the laser transmitter at required height.
- C. Use the Multi bracket to mount the laser transmitter vertically on a magnet base.

XT20/XT22 Display views

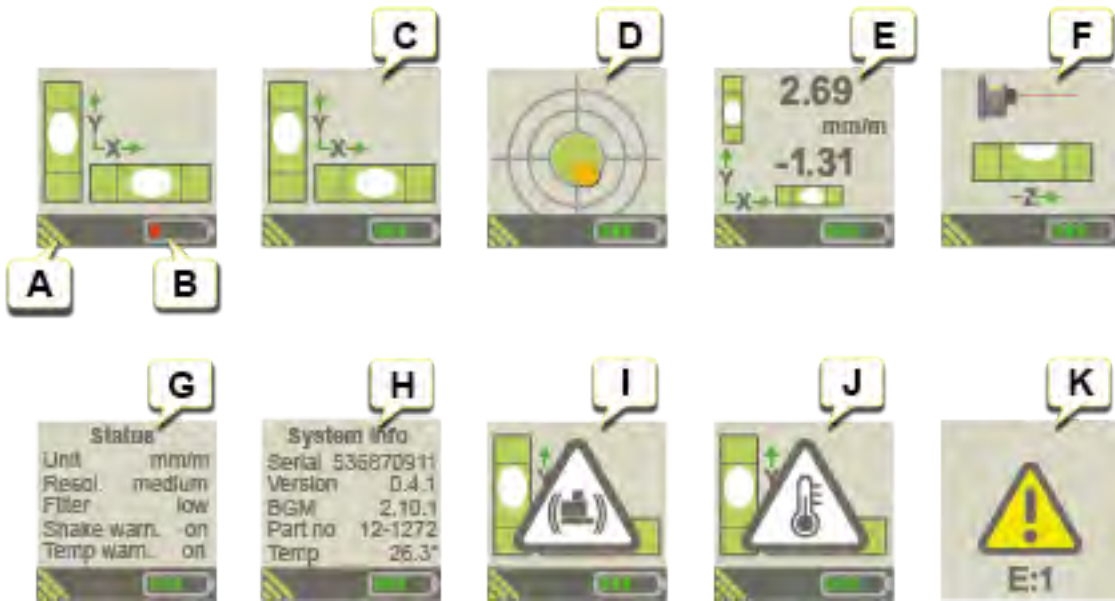

- A. Wireless XT connection.
- B. Battery status. If necessary, charge the XT20/XT22.
- C. Measuring view: Electronic levels.
- D. Measuring view: "Cross view".
- E. Precision measuring view: High accuracy measurement values (for example presented in millimeters per meter).
- F. Vertical measuring view.
- G. View of settings made in the app.
- H. System information.
- I. Shake warning, *see below*.
- J. Temperature warning, *see below*.
- K. No access to device, error code E1. The unit must be sent for repair.

Warnings during measurement

The following Warnings may appear in the XT20/XT22 display:

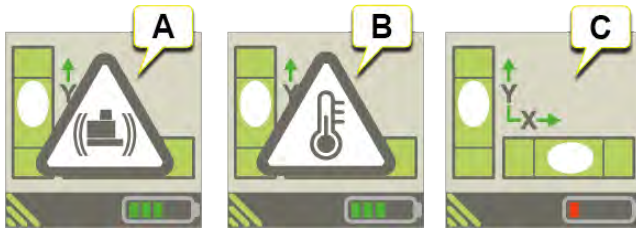

- A. Shake warning for laser transmitter. If vibrations are strong enough to make the shake warning appear during measurement, increase the filter level of electronic levels from the XT app (via the Context menu).
- B. Temperature warning for laser transmitter.
- C. Low battery warning. Charge the laser transmitter.

NOTE! When shake warning or temperature warning appears, it can be cleared by pressing any button on the laser transmitter. However, it is recommended to clear the warning from the XT app during measurement to avoid movements of the laser transmitter.

NOTE! You can deactivate shake warning and temperature warning completely by selecting "OFF" in the XT app.

CALIBRATE XT20/XT22 ELECTRONIC LEVELS HORIZONTALLY

You can calibrate the electronic levels on the XT20/XT22 laser transmitter. This is done at factory, but should be redone prior to a job, if you want to measure with respect to the horizontal (or vertical) level. By calibrating the electronic levels and then using them to level the laser transmitter, you can achieve an absolute leveling of the laser plane of approximately ± 0.02 mm/m [4 arc sec].

Start the Calibration program (only applicable to horizontal levels) via the app Context menu > "Calibrate X&Y" and follow the instructions. The app will guide you through the calibration procedure. After each step in the procedure, tap  to proceed to next step.

When you start the calibration sequence, the previous calibration settings of both horizontal electronic levels will be cleared, and the levels will return to their factory calibration settings. When the full calibration sequence has been completed, the new calibration settings calculated from the calibration procedure will be used in the electronic levels.

Before starting the calibration procedure, connect detector and laser transmitter.

NOTE! App calibration program is only applicable to horizontal levels.



NOTE! Place laser transmitter according to the orientation shown in the animation. Always start with the X direction when calibrating horizontally.

NOTE! Only XT70 detector can be used when calibrating the XT20/22 laser transmitter.



Self instructing Calibration guide in the app.

Calibrate first electronic level

1. Place the laser transmitter [A] on a flat, clean and stable surface. Tap  to start calibration sequence.
2. Mark base of laser transmitter. Tap .
3. Level the laser transmitter according to both electronic levels by using the tilt screws [B]. Tap .

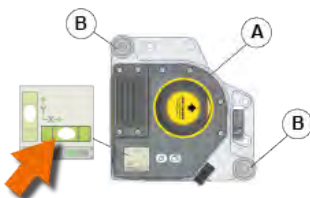

Zero set

4. Place the detector [C] at a distance of minimum 1 m, but preferably 5-10 m, and center the detector to the laser beam, within 0.5 mm horizontally, by moving **the detector**. Do not touch the laser transmitter. Tap . Zero setting of value is done automatically by the app.



Index and level

5. Rotate laser transmitter body 180° (laser transmitter positioned according to marking in step 2). Tap
6. Level the laser transmitter according to the electronic levels by using the tilt screws [D]. Tap
7. Use fine adjustment knob [E] (highlighted in the app) on the laser transmitter to center the laser beam horizontally, within 0.5 mm, on the detector. Do not touch the detector. Tap . Halving of value is done automatically by the app.

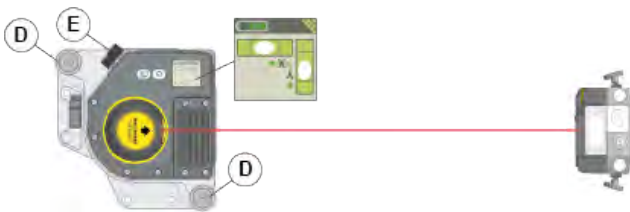

Adjust value

8. Fine adjust the V-value of the detector PSD to 0.00 by using the tilt screw [F] (highlighted in the app) on the laser transmitter. Tap to calibrate.



Calibrate level

9. The zero point of the electronic level is now auto calibrated. Tap .

Calibrate second electronic level

10. Rotate laser transmitter body 90°. Tap .
11. Repeat step 3–9.

LASER TRANSMITTERS

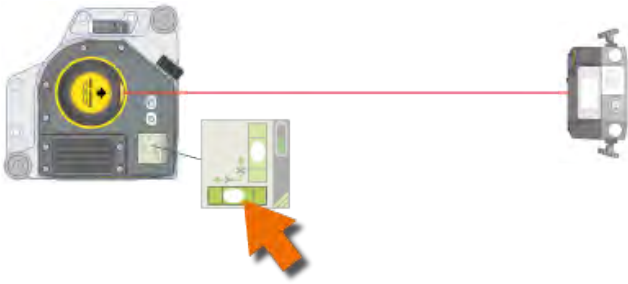

Verification of calibration accuracy

12. After both levels have been calibrated, the accuracy of the calibration can be verified (optional). Tap  to proceed to the verification procedure and follow the instructions in the app. To exit the calibration procedure without verification, press the button in the upper left corner to return to the main program.

CALIBRATE XT22 ELECTRONIC LEVEL VERTICALLY

Before you calibrate the vertical electronic level, you need to calibrate both horizontal electronic levels. The app does not provide a calibration program for the XT22 vertical level. Instead, the calibration is performed manually by using the VALUES program.

NOTE! Only XT70 detector can be used when calibrating the XT22 laser transmitter.

Level horizontally

1. Select $\begin{matrix} V 0.00 \\ H 0.00 \end{matrix}$ to open the program Values. Connect detector and laser transmitter.
2. Go to measurement view .
3. Place the laser transmitter [A] on a flat, clean and stable surface.
4. Level the laser transmitter according to the electronic levels by using the tilt screws [B].

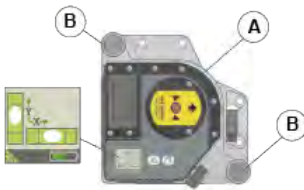

Rough align

5. Place the detector on position 1 and move the detector until the laser beam hits the center.
6. Mark the position of the detector.
7. Move the detector to position 2 and move the detector until the laser beam hits the center.
8. Mark the position of the detector.

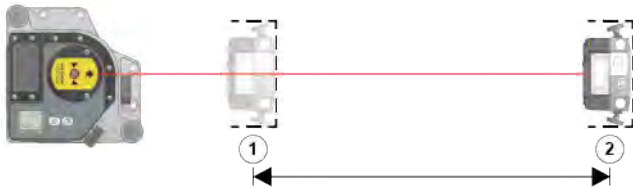

Minimum 1 m, but preferably 5-10 m, between position A and position B.

Zero set and read value

9. Move the detector back to position 1.
10. Select 0 to zero set.
11. Move the detector to position 2. Tap  to save the value.



Mount the laser transmitter vertically

12. Mount the laser transmitter vertically using Multi bracket 12-1275 and/or other mounting options.
13. Rough align the detector on position 2 ($\pm 0.1\text{mm}$).

NOTE! The laser transmitter must be mounted with the XT22 product label facing upwards. See image below.

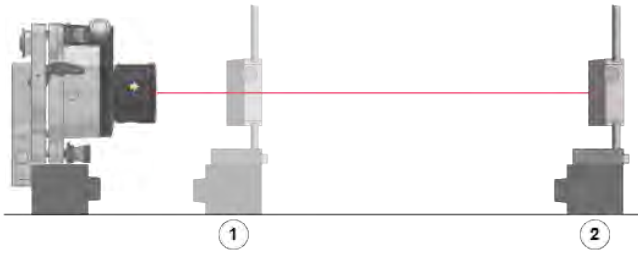

Zero set and adjust

14. Move the detector back to position 1.
15. Select 0 to zero set.
16. Move the detector to position 2.
17. Adjust the laser transmitter until you have the same vertical value as saved in step 11 by using the tilt screw [C].
18. Repeat steps 14–17 until you have 0 on position 1 and the correct value on position 2.

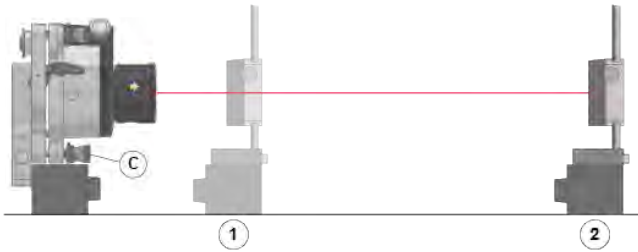

Calibrate spirit level

19. Calibrate the electronic level via the app Context menu of the laser transmitter by selecting "Calibrate Z".

Verification of calibration accuracy

20. Repeat steps 4-18 and check the electronic level live reading. The live reading of the electronic level should now be close to zero.

LASER TRANSMITTER D22

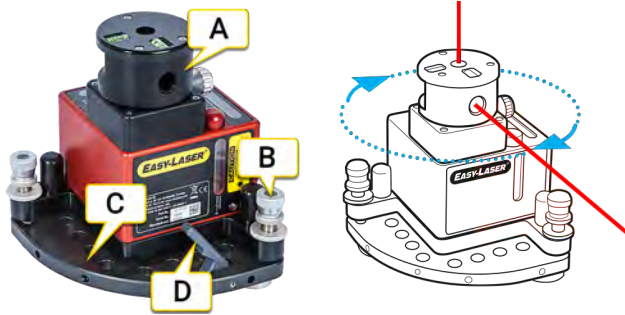

- A. Rotatable head with angular prism.
- B. Tilting screw.
- C. Tilting table.
- D. The release lever has to be removed before the D22 can be mounted on a tripod.

Tilting screws

The tilting screws on the levelling table of the laser transmitter have to be operated carefully and according to instructions.

Visual rough alignment to (detector) target

Check the position of the fine adjustment screw. It should be in its nominal position approx. 2.5 mm.

1. Loosen the locking screw.
2. Adjust with the course screw to wanted position.
3. Tighten the locking screw.

Digital fine adjustment to detector and read values

1. Check so that the locking screw is tightened.
2. Adjust with the fine adjustment screw to wanted value.



1. Fine adjustment screw
2. Coarse screw
3. Locking screw
4. Maximum position

Safety strap

Use an approved safety strap to prevent equipment from falling and causing injuries. Choose a safety strap that has been approved for the weight it should carry, and for the circumstances under which it will be used. Always follow your company's internal rules for safe work. The safety strap should be connected to the equipment using the M6 screw provided (part. no 01-1402). Check the strap for damages and wear regularly. If it has been involved in a sharp drop, please replace it. Fasten the strap **above** the equipment.

Calibrate D22

- See "Level D22 horizontally" on the facing page
- See "Level D22 vertically" on page 275

Technical data D22

- See "D22 Technical data " on page 301

LEVEL D22 HORIZONTALLY

Calibrate the horizontal spirit levels

You can calibrate the spirit levels on the D22 laser transmitter. This is done at factory, but should be redone prior to a job. The spirit levels are scaled to 0.02 mm/m [4 arc sec.]. By calibrating the spirit levels and then use them to level the laser transmitter, you can achieve an absolute levelling of the laser plane of approximately 0.01 mm/m [2 arc sec.].

Level

1. Place the D22 laser transmitter on a flat and stable surface.
2. Level the laser transmitter according to the spirit levels. Use the tilting screws.



Level the laser transmitter

Zero set

3. Place the detector at a distance of 5-10 metres. Make sure that the laser beam hits the detector target.
4. Tap $V_{H0.00}^{0.00}$ to open the program Values.
5. Tap 0 to zero set.



5-10 m between laser and detector

Index and level

6. Rotate the D22 180° and turn the laser beam to the detector.
7. Level the laser transmitter according to the spirit levels. Use the tilting screws.



Rotate laser transmitter 180° and level the laser transmitter.

LASER TRANSMITTERS

Adjust value

8. Tap $\frac{1}{2}$ to halve the value.
9. Adjust the V-value to 0.00 using the tilting screw.



Halve value and adjust to 0.00 using this tilting screw.

Calibrate first spirit level

10. Calibrate the spirit level using a hex key.
11. Repeat step 6–9 to control.

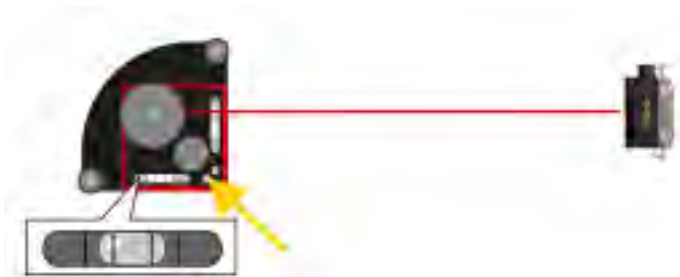

Calibrate the spirit level using this screw.

Calibrate second spirit level

12. Rotate the D22 90° and turn the laser beam to the detector.
13. Repeat step 4–12.



Adjust second spirit level.

See "Level D22 vertically" on the facing page

See "D22 Technical data " on page 301

LEVEL D22 VERTICALLY

Before you calibrate the vertical spirit level, you need to calibrate both horizontal spirit levels.

Level horizontally

1. Place the D22 laser transmitter on a flat, clean and stable surface.
2. Level the laser transmitter according to the spirit level. Use the tilting screws.

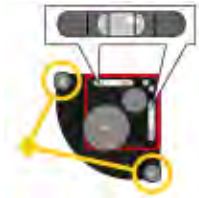

Level the laser transmitter.

Rough align

3. Select $\begin{matrix} V 0.00 \\ H 0.00 \end{matrix}$ to open the program Values.
4. Place the detector on position **A** and move the detector until the laser beam hits the center.
5. Mark the position of the detector.
6. Move the detector to position **B** and move the detector until the laser beam hits the center.
7. Mark the position of the detector.

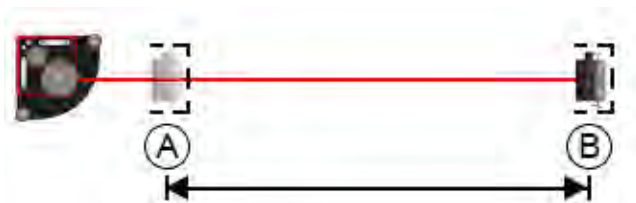

Minimum 1m between position A and position B.

Zero set and read value

8. Move the detector back to position **A**.
9. Select 0 to zero set.
10. Move the detector to position **B**. Read and note the vertical value.



Zero set at position A. Read value on position B.

Mount the D22 vertically

11. Mount the D22 vertically using the pin (01-0139) or a plate (01-0874).
12. Rough align the detector on position **B** ($\pm 0.1\text{mm}$).

LASER TRANSMITTERS



Mount vertically and rough align on position B.

Zero set and adjust

13. Move the detector back to position **A**.
14. Select 0 to zero set.
15. Move the detector to position **B**.
16. Adjust until you have the same value as in step 10. Use the tilting screw.
17. Repeat steps 13–16 until you have 0 on position **A** and the right value on position **B**.

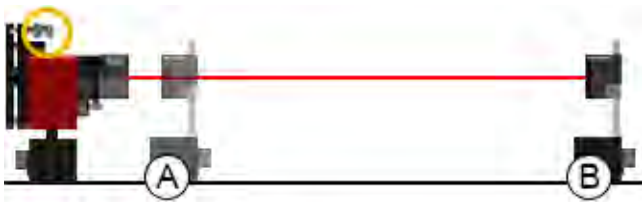

Zero set at position A. Read value on position B.

Calibrate spirit level

18. Calibrate the spirit level using a hex key.

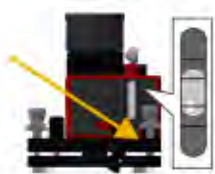

TECHNICAL DATA

DISPLAY UNIT XT12

Part no. 12-1291 (12-1292 including IR Camera).

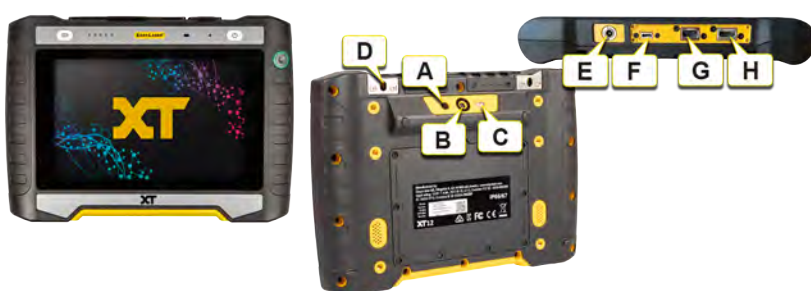

- A. IR Camera (optional)
- B. 13 Mp Camera
- C. LED Light
- D. Fastening points for shoulder strap (x2)
- E. Charger port
- F. USB C
- G. USB A
- H. HDMI connector

NOTE! This device is a part of a measuring system and the intended use for the device is industrial measuring together with other Easy-Laser products, according to the instructions in this manual. The device is intended for professional use only. Neither Easy-Laser nor its authorized distributors shall be liable for damage to machinery or systems caused by improper use of this device.

SERVICE AND SUPPORT

If the unit is damaged it has to be sent for repair. Contact your local service center as found on www.easylaser.com.

Display unit

Type of display/size	8" LCD capacitive multi-touch color display
Battery type	Heavy duty Li Ion chargeable
Operating time	Up to 16 h continuously
Connections	USB-C, USB-A, HDMI, DC-jack (charging, 15 V 4 A)

TECHNICAL DATA

Communication	Wireless technology, WiFi
Camera, with diode lamp	13 Mp Autofocus
IR camera (optional)	FLIR LEPTON® 3.5 Long Wave Infrared, 160x120 pxl, 0–400 °C, [32–752 °F]
Help functions	Built-in manual
Environmental protection	IP class 66/67
Operating temperature	-10–50 °C [14–122 °F]
Storage temperature	-20–50 °C [-4–122 °F]
Relative humidity	10–95%
Loudspeakers	Built-in, rear-facing
Housing material	PC/TPE or PC/TPU
Dimensions	WxHxD: 269x190x49.4 mm [10.59x7.48x1.95"]
Weight	1400 g [49.4 oz]
Altitude	0-2000 m [6560 ft] during operation. 0-3000 m [9840 ft] during storage/transport
Designed for outdoor use (pollution degree 4)	

Switch battery

If batteries need to be switched, contact your local service center.

Only use batteries provided by Easy-Laser.

DISPLAY UNIT XT11

Part. no 12-0961



- A. IR Camera (optional)
- B. 13 Mp Camera
- C. LED Light
- D. Fastening points for shoulder strap (x4)
- E. Charger
- F. USB A
- G. HDMI connector
- H. USB B

NOTE! This device is a part of a measuring system and the intended use for the device is industrial measuring together with other Easy-Laser products, according to the instructions in this manual. The device is intended for professional use only. Neither Easy-Laser nor its authorized distributors shall be liable for damage to machinery or systems caused by improper use of this device.

SERVICE AND SUPPORT

If the unit is damaged it has to be sent for repair. Contact your local service center as found on www.easylaser.com.

Display unit

Type of display/size	SVGA 8" color screen, backlit LED, multitouch
Battery type	Heavy duty Li Ion chargeable
Operating time	Up to 16 h continuously
Connections	USB A, USB B, Charger, AV
Communication	Wireless technology
Camera, with diode lamp	13 Mp
IR camera (optional)	FLIR LEPTON® Long Wave Infrared
Help functions	Built-in manual
Environmental protection	IP class 66 and 67
Operating temperature	-10–50 °C
Storage temperature	-20–50 °C
Relative humidity	10–95%
OLED display	96x96 pixels
Housing material	PC/ABS + TPE
Dimensions	WxHxD: 274x190x44 mm [10.8x7.5x1.7"]
Weight	1450 g [51.1 oz]

TECHNICAL DATA

Altitude	0-2000m
Designed for outdoor use (pollution degree 4)	

Switch battery

If batteries need to be switched, contact your local service center.

Only use batteries provided by Easy-Laser.

NOTE! As of November 2022, the XT alignment app will no longer support the XT11 rev 1 Display unit (serial number 129231 or lower). XT alignment app version 8.1 and higher will not be compatible with XT11 rev 1.

XT40 TECHNICAL DATA

Part. no 12-0943

Part. no 12-0944

The XT40 measuring units have large 30mm PSD, and OLED displays which shows the angle of the units.



NOTE! This device is a part of a measuring system and the intended use for the device is industrial measuring together with other Easy-Laser products, according to the instructions in this manual. The device is intended for professional use only. Neither Easy-Laser nor its authorized distributors shall be liable for damage to machinery or systems caused by improper use of this device.

SERVICE AND SUPPORT

If the unit is damaged it has to be sent for repair. Contact your local service center as found on www.easylaser.com.

Type of detector	TruePSD 30 mm [1.2"]
Communication	Wireless technology
Battery type	Heavy duty Li Ion chargeable [3.7 V, 7.4 Wh, 2000 mAh]
Operating time	Up to 24 h continuously
Resolution	+/- 0.005 mm +1% [0.2 mils]
Measurement accuracy	±1 µm ±1%
Measurement range	Up to 10 m [33 feet]
Type of laser	Diode laser
Laser wavelength	630–680 nm
Laser class	Safety class 2
Laser output power	<0.6 mW
Electronic inclinometer	0.1° resolution
Environmental protection	IP class 66 and 67
Operating temperature	-10–50 °C
Storage temperature	-20–50 °C
Relative humidity	10–95%
OLED display	128x64 pixels
Housing material	Anodized aluminum + PC/ABS + TPE
Dimensions	WxHxD: 76x76.7x39.3 mm [3.0x3.0x1.5"]
Weight	245 g [8.6 oz]
Altitude	0-2000m
Designed for outdoor use (pollution degree 4)	

Switch battery

If batteries need to be switched, contact your local service center.

Only use batteries provided by Easy-Laser.

Laser classification

The XT40 is classified as laser class 2, for more information, See "Safety precautions" on page 331.

These products are safe under reasonably foreseeable conditions of operation and are not harmful to the eyes provided that the products are used and maintained in accordance with this User Manual.

Average power	Max. 0.6 mW
Pulse duration	4–6 μ s
Pulse energy	Max. 8 nJ
Wavelength	630–680 nm
Beam divergence	1.5 mrad x 200 mrad
Pulse repetition frequency	75–120 kHz

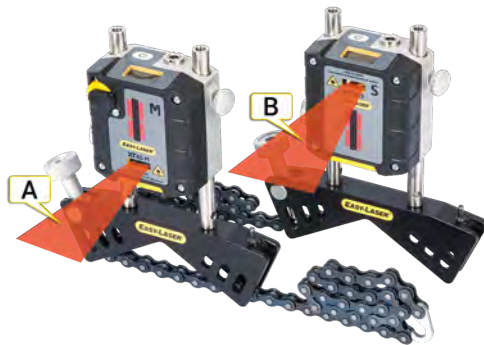

- A. Laser beam on M-unit
- B. Laser beam on S-unit

Labels with laser safety precautions

Label on the back of XT40:



Label on the front of XT40:

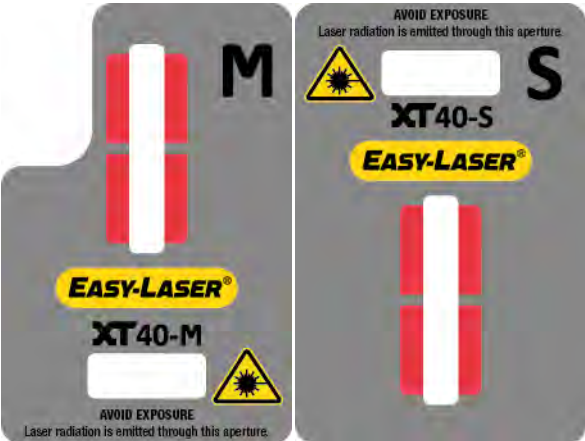

XT50 TECHNICAL DATA

XT50 is designed for use in potentially explosive (EX) atmospheres. Specific EX certifications apply; see the technical data below. **Please read and follow the safety instructions described below.**

Part. no 12-1027

Part. no 12-1028



NOTE! This device is a part of a measuring system and the intended use for the device is industrial measuring together with other Easy-Laser products, according to the instructions in this manual. The device is intended for professional use only. Neither Easy-Laser nor its authorized distributors shall be liable for damage to machinery or systems caused by improper use of this device.

Type of detector	1 axis TruePSD 20x20 mm [0.79x0.79"]
Communication	Wireless technology
Battery type	Heavy duty Li Ion chargeable
Operating time	Up to 20 h continuously
Resolution	0.001 mm [0.05 mils]
Measurement accuracy	±0.001 mm ±1% [±0.05 mils ±1%]
Measurement range	Up to 20 m [66 feet]
Type of laser	Diode laser
Laser wavelength	630–680 nm
Laser class	Safety class 2
Laser output	<1 mW
Electronic inclinometer	0.1° resolution
Environmental protection	IP class 66 and 67
Operating temperature	-10 to +50 °C [14 to 122 °F] (ambient)
Storage temperature	-20 to +50 °C [-4 to 122 °F] (ambient)
Altitude	0-2000 m
Relative humidity	10–95%
OLED display	128x64 pixels
Housing material	Anodized aluminum + PC/ABS + TPE
Dimensions	WxHxD: 76x76.5x50.9 mm [3.0x3.0x2.0"]
Weight	316 g [11.1 oz]
Ex classifications	Ⓔ II 2G Ex ib op is IIC T4 Gb, -10°C ≤ Ta ≤ +50°C *

	Ⓔ II 2D Ex ib op is IIIC T135°C Db, -10°C ≤ Ta ≤ +50°C *
Ex certificates	Presafe 17 ATEX 10552X
	IECEX PRE 17.0049X
Designed for outdoor use (pollution degree 4)	

* EX-classification explanation, see below.

Switch battery or repair

If batteries need to be switched or the unit needs to be repaired, the unit must be sent to the Swedish service center.

Only use batteries provided by Easy-Laser.

Laser classification

The XT50 is classified as laser class 2, for more information, See "Safety precautions" on page 331.

These products are safe under reasonably foreseeable conditions of operation and are not harmful to the eyes provided that the products are used and maintained in accordance with this User Manual.

Average power	Max. 0.6 mW
Pulse duration	10–17 µs
Pulse energy	Max. 20 nJ
Wavelength	630–680 nm
Beam divergence	< 1.5 mrad
Pulse repetition frequency	32–47 kHz



A. Laser beam on M-unit

B. Laser beam on S-unit

* EX-classification explanation:

II = Product group. Indicates that the instrument is approved for all areas except mines.

2G = Product category for gas atmosphere. Intrinsically safe equipment for zones 1 and 2 (likely occurrence of explosive gas atmosphere – gases, mists and vapours).

2D = Product category for dust atmosphere. Intrinsically safe equipment for zones 21 and 22 (likely occurrence of explosive dust atmosphere).

ib op is = Type of EX protection (intrinsic safety and safe laser radiation levels).

IIC = Explosion group for gas atmosphere. Example gases: Hydrogen & Acetylene.

TECHNICAL DATA

IIC = Dust classification. Indicates that the instrument is approved for dust from flammable fibres, non conductive dust and conductive dust.

T4 = Temperature class for gas atmosphere. The temperature class indicates the maximum temperature of the exposed surface of the

product, corresponding to a maximum temperature of 135°C.

T135°C = Temperature class for dust atmosphere. Indicates that the maximum temperature of the exposed surface of the product is 135°C.

Gb = Equipment protection level for gas atmosphere. Corresponds to zone 1 and 2.

Db = Equipment protection level for dust atmosphere. Corresponds to zone 21 and 22.

Ta = Ambient temperature. Indicates that the product is safe for use in EX environments in the ambient temperature range as stated only.

Safety precautions/Warning

- **Do not charge in potentially explosive environment!**
- Always read and follow operation instructions.
- Opening the housing of the units will invalidate the Ex-rating, voids warranty and may result in hazardous light exposure.
- All repairs must be done by Easy-Laser main service center in Sweden.
- Only use the included Easy-Laser charger (12 V).
- The EX rating is valid for the XT50 measuring units only (part number 12-1026 & 12-1027). Brackets, fixturing equipment, case, and other accessories are not subject to any EX classification, and must be assessed by the user before use in EX environment. Easy-Laser does not take responsibility for the EX safety of accessories

Labels with laser safety precautions

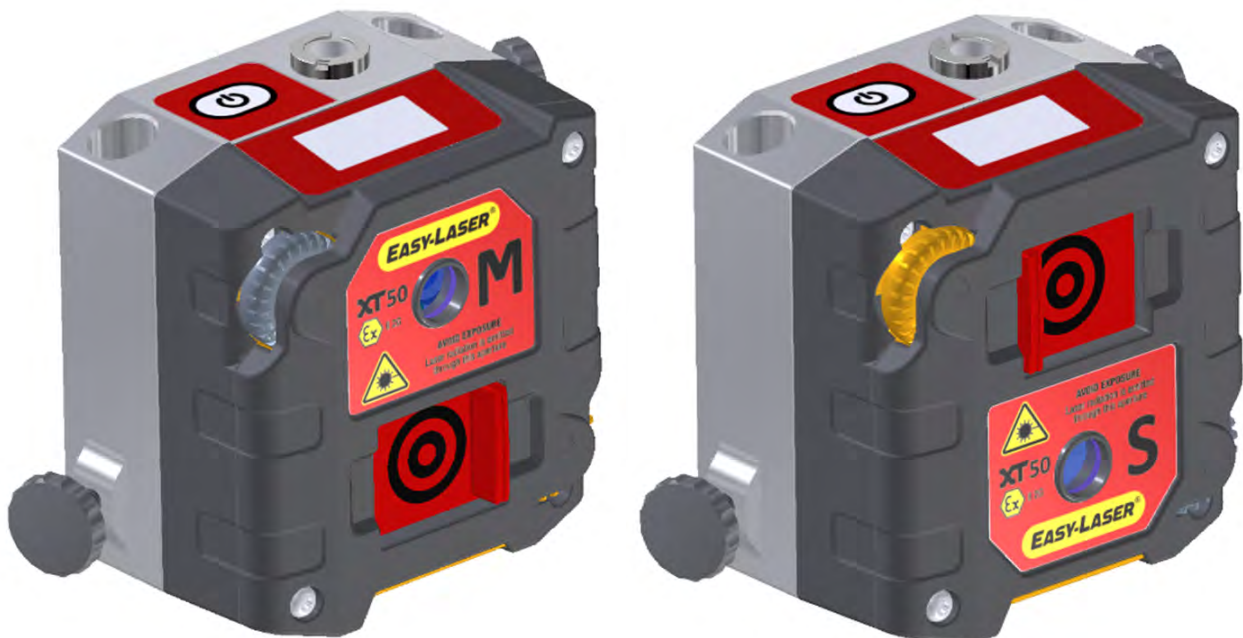



Complies with: 21 CFR 1040.10 and 1040.11 except for conformance with IEC 60825-1 Ed. 3., as described in Laser Notice No. 56, dated May 8, 2019. EN 60825-1:2014+A11:2021.

Contains: FCC ID: Q0QBGM111, IC: 5123A-BGM111
Li-Ion battery 3.7 V 1960 mAh 7.25 Wh

LASER 2

AVERAGE POWER < 0.6 mW. PULSE ENERGY < 20 nJ.
PULSE DURATION 10-17 µs. WAVELENGTH 630-680 nm.

WARNING! DO NOT CHARGE IN POTENTIALLY EXPLOSIVE ENVIRONMENT

Ex II 2G Ex ib op is IIC T4 Gb
II 2D Ex ib op is IIIC T135°C Db
-10°C ≤ Ta ≤ +50°C
Presafe 17 ATEX 10552X, IECEx PRE 17.0049X

Part No. [Redacted] **CE**
Serial No. [Redacted] 0470
Manufactured [Redacted] **IP66/67**

Calibration due: **XT50**

Easy-Laser AB
Alfagatan 6, 431 49 Mölndal, Sweden. www.easylaser.com

XT60 TECHNICAL DATA

Part. no 12-1028

Part. no 12-1029

The XT60 measuring units have large 20x20mm PSD, and OLED displays which shows the angle of the units.



NOTE! This device is a part of a measuring system and the intended use for the device is industrial measuring together with other Easy-Laser products, according to the instructions in this manual. The device is intended for professional use only. Neither Easy-Laser nor its authorized distributors shall be liable for damage to machinery or systems caused by improper use of this device.

SERVICE AND SUPPORT

If the unit is damaged it has to be sent for repair. Contact your local service center as found on www.easylaser.com.

Type of detector	1 axis TruePSD 20x20 mm [0.79x0.79"]
Communication	Wireless technology
Battery type	Heavy duty Li Ion chargeable [3.7 V, 7.4 Wh, 2000 mAh]
Operating time	Up to 24 h continuously
Resolution	0.001 mm [0.05 mils]
Measurement accuracy	±1 µm ±1%
Measurement range	Up to 20 m [66 feet]
Type of laser	Diode laser
Laser wavelength	630–680 nm
Laser class	Safety class 2
Laser output power	<0.6 mW
Electronic inclinometer	0.1° resolution
Environmental protection	IP class 66 and 67
Operating temperature	-10–50 °C
Storage temperature	-20–50 °C
Relative humidity	10–95%
OLED display	128x64 pixels
Housing material	Anodized aluminum + PC/ABS + TPE
Dimensions	WxHxD: 76x76.4x45.9 mm [3.0x3.0x1.8"]
Weight	272 g [9.6 oz]
Altitude	0-2000m
Designed for outdoor use (pollution degree 4)	

Switch battery

If batteries need to be switched, contact your local service center.

Only use batteries provided by Easy-Laser.

Laser classification

The XT60 is classified as laser class 2, for more information See "Safety precautions" on page 331.

These products are safe under reasonably foreseeable conditions of operation and are not harmful to the eyes provided that the products are used and maintained in accordance with this User Manual.

Average power	Max. 0.6 mW
Pulse duration	10–17 µs
Pulse energy	Max. 20 nJ
Wavelength	630–680 nm
Beam divergence	< 1.5 mrad
Pulse repetition frequency	32–47 kHz



- A. Laser beam on M-unit
- B. Laser beam on S-unit

Labels with laser safety precautions

Label on the back of XT60:



TECHNICAL DATA

Label on the front of XT60:



XT70 TECHNICAL DATA

Part. no 12-1045

Part. no 12-1046

The XT70 measuring units have a dot-type laser and 2-axis square PSD surfaces. It has 20x20mm PSD, and OLED displays which shows the angle of the units.



NOTE! This device is a part of a measuring system and the intended use for the device is industrial measuring together with other Easy-Laser products, according to the instructions in this manual. The device is intended for professional use only. Neither Easy-Laser nor its authorized distributors shall be liable for damage to machinery or systems caused by improper use of this device.

SERVICE AND SUPPORT

If the unit is damaged it has to be sent for repair. Contact your local service center as found on www.easylaser.com.

Type of detector	2 axis TruePSD 20x20 mm [0.79x0.79"]
Communication	Wireless technology
Battery type	Heavy duty Li Ion chargeable [3.7 V, 7.4 Wh, 2000 mAh]
Operating time	Up to 24 h continuously
Resolution	0.001 mm [0.05 mils]
Measurement accuracy	±1 µm ±1%
Measurement range	Up to 20 m [66 feet]
Type of laser	Diode laser
Laser wavelength	630–680 nm
Laser class	Safety class 2
Laser output power	<0.6 mW
Electronic inclinometer	0.1° resolution
Environmental protection	IP class 66 and 67
Operating temperature	-10–50 °C
Storage temperature	-20–50 °C
Relative humidity	10–95%
OLED display	128x64 pixels
Housing material	Anodized aluminum + PC/ABS + TPE
Dimensions	WxHxD: 76x76.4x45.9 mm [3.0x3.0x1.8"]
Weight	272 g [9.6 oz]
Altitude	0-2000m
Designed for outdoor use (pollution degree 4)	

TECHNICAL DATA

Switch battery

If batteries need to be switched, contact your local service center.

Only use batteries provided by Easy-Laser.

Laser classification

The XT70 is classified as laser class 2, for more information See "Safety precautions" on page 331.

These products are safe under reasonably foreseeable conditions of operation and are not harmful to the eyes provided that the products are used and maintained in accordance with this User Manual.

Average power	Max. 0.6 mW
Pulse duration	10–17 μ s
Pulse energy	Max. 20 nJ
Wavelength	630–680 nm
Beam divergence	< 1.5 mrad
Pulse repetition frequency	32–47 kHz



- A. Laser beam on M-unit
- B. Laser beam on S-unit

Labels with laser safety precautions

Label on the back of XT70:



Label on the front of XT70:



XT20/XT22 TECHNICAL DATA

XT20 part. no 12-1272, XT22 part. no 12-1273.

Laser transmitter XT20/XT22 with digital display and electronic levels.
 Laser head (with reversible angular prism for XT22) that can be rotated by hand.
 XT20 and XT22 can be used with XT programs Straightness and Values.



XT20



XT22

NOTE! This device is a part of a measuring system and the intended use for the device is industrial measuring together with other Easy-Laser products, according to the instructions in this manual. The device is intended for professional use only. Neither Easy-Laser nor its authorized distributors shall be liable for damage to machinery or systems caused by improper use of this device.

NOTE! The tilting screws on the levelling table have to be operated carefully and according to instructions. See "Laser transmitter XT20/XT22" on page 259

SERVICE AND SUPPORT

If the unit is damaged it has to be sent for repair. Contact your local service center as found on www.easylaser.com.

Type of laser	XT20: Diode laser XT22: Fiber-coupled diode laser
Laser wavelength	630–680 nm
Laser safety class	Class 2
Laser output power	<0.6 mW
Beam diameter	XT20: 6 mm [0.24"] at aperture, 10 mm [0.39"] at 20 m [66'] XT22: 6 mm [0.24"] at aperture, 13 mm [0.51"] at 40 m [132']
Working range	XT20: 20 m radius [66'] XT22: 40 m radius [132']
Communication	BT Wireless technology
Warning indications	Temperature drift and shake/vibration
Connections	Charger
Type of battery	Heavy duty Li-Ion chargeable
Operating time	Up to 30 hours continuous use
Warmup time	15 min
Operating temperature	-10–50 °C [14–122 °F]
Charging temperature (battery)	0–50 °C [32–122 °F]
Storage temperature	-20–50 °C [-4–122 °F]
Relative humidity	10–95% non-condensing
Number of precision levels	XT20: 2 pcs Horizontal XT22: 2 pcs Horizontal, 1 pc Vertical
Precision level range	± 10 mm/m [± 10 mils/inch]

Precision level accuracy	± 0.02 mm/m ±1% [± 0.02 mils/inch ±1%]
Precision level sensitivity	0.001 mm/m [0.001 mils/inch]
Laser beam straightness	XT20: ± 0.01 mm [± 0.4 mils] XT22: ± 0.003 mm [± 0.12 mils]
Laser plane flatness	± 0.01 mm/m [± 0.01 mils/inch]
Squareness between laser beams	XT20: N/A XT22: ± 0.01 mm/m [± 0.01 mils/inch]
Laser head fine turning	XT20: 1:132 gear ratio XT22: 1:1320 gear ratio
Environmental protection	XT20: IP 55. Designed for outdoor use (pollution degree 4) XT22: IP N/A. Designed for industrial use (pollution degree 3)
TFT display	240x240 pixels, RGB color
Housing material	Anodized aluminium + PC/ABS + TPU
Dimensions	XT20: WxHxD: 147x126x152 mm [5.79x4.97x5.98"] XT22: WxHxD: 147x136x152 mm [5.79x5.35x5.98"]
Weight	XT20: 2065 g [72.86 oz] XT22: 2264 g [79.86 oz]
Altitude	0-3000 m during storage/transport 0-2000 m during operation

Switch battery

If batteries need to be switched, contact your local service center.

Only use batteries provided by Easy-Laser.

Labels with laser safety precautions

Label on the back of XT20

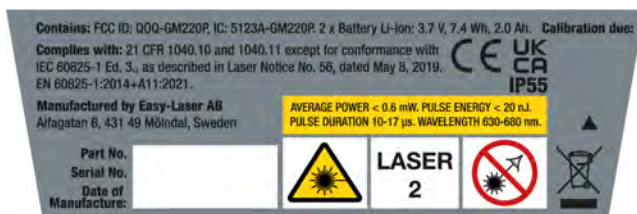

Label on the XT20 laser head



Label on the back of XT22

TECHNICAL DATA

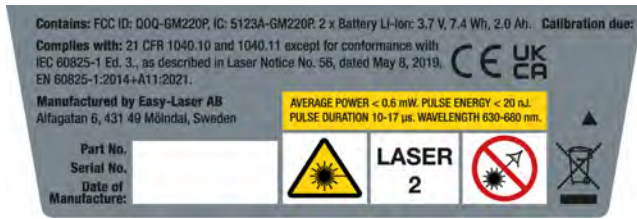

Label on the XT22 laser head

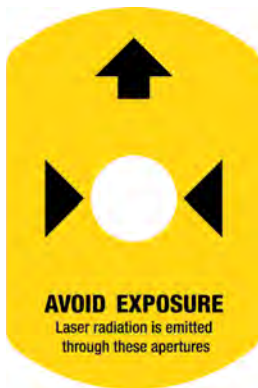

XT21 TECHNICAL DATA

XT21 part. no 12-xxxx.

XT21 is a xxx laser with digital display and electronic levels.
The XT21 can be used with Sparrow program ... xxxx.



NOTE! This device is a part of a measuring system and the intended use for the device is industrial measuring together with other Easy-Laser products, according to the instructions in this manual. The device is intended for professional use only. Neither Easy-Laser nor its authorized distributors shall be liable for damage to machinery or systems caused by improper use of this device.

NOTE! The tilting screws on the levelling table have to be operated carefully and according to instructions. Go to Laser transmitter XT23.

SERVICE AND SUPPORT

If the unit is damaged it has to be sent for repair. Contact your local service center as found on www.easylaser.com.

Type of laser	XT23: Spin laser
Laser wavelength	630–680 nm
Laser safety class	Class 2
Laser output power	<0.6 mW
Beam diameter	6 mm [0.24"] at aperture, 10 mm [0.39"] at 20 m [66']
Working range	20 m radius [66']
Communication	BT Wireless technology
Warning indications	Temperature drift and shake/vibration
Connections	Charger
Type of battery	Heavy duty Li-Ion chargeable

TECHNICAL DATA

Operating time	Up to 30 hours continuous use
Warmup time	15 min
Operating temperature	-10–50 °C [14–122 °F]
Charging temperature (battery)	0–50 °C [32–122 °F]
Storage temperature	-20–50 °C [-4–122 °F]
Relative humidity	10–95% non-condensing
Number of precision levels	2 pcs Horizontal
Precision level range	± 10 mm/m [± 10 mils/inch]
Precision level accuracy	± 0.02 mm/m ±1% [± 0.02 mils/inch ±1%]
Precision level sensitivity	0.001 mm/m [0.001 mils/inch]
Laser beam straightness	± 0.01 mm [± 0.4 mils]
Laser plane flatness	± 0.01 mm/m [± 0.01 mils/inch]
Squareness between laser beams	± 0.01 mm/m [± 0.01 mils/inch]
Laser head fine turning	1:132 gear ratio
Environmental protection	IP 55. Designed for outdoor use (pollution degree 4)
TFT display	240x240 pixels, RGB color
Housing material	Anodized aluminium + PC/ABS + TPU
Dimensions	WxHxD: 147x126x152 mm [5.79x4.97x5.98"]
Weight	2065 g [72.86 oz]
Altitude	0-3000 m during storage/transport 0-2000 m during operation

Switch battery

If batteries need to be switched, contact your local service center.

Only use batteries provided by Easy-Laser.

Labels with laser safety precautions

Label on the back of XT21

Label on the XT21 laser head

XT23 TECHNICAL DATA

XT23 part. no 12-xxxx.

XT23 is a spin laser with digital display and electronic levels.
The XT23 can be used with Sparrow program Flange flatness.



NOTE! This device is a part of a measuring system and the intended use for the device is industrial measuring together with other Easy-Laser products, according to the instructions in this manual. The device is intended for professional use only. Neither Easy-Laser nor its authorized distributors shall be liable for damage to machinery or systems caused by improper use of this device.

NOTE! The tilting screws on the levelling table have to be operated carefully and according to instructions. Go to Laser transmitter XT23.

SERVICE AND SUPPORT

If the unit is damaged it has to be sent for repair. Contact your local service center as found on www.easylaser.com.

Type of laser	XT23: Spin laser
Laser wavelength	630–680 nm
Laser safety class	Class 2
Laser output power	<0.6 mW
Beam diameter	6 mm [0.24"] at aperture, 10 mm [0.39"] at 20 m [66']
Working range	20 m radius [66']
Communication	BT Wireless technology
Warning indications	Temperature drift and shake/vibration
Connections	Charger
Type of battery	Heavy duty Li-Ion chargeable

TECHNICAL DATA

Operating time	Up to 30 hours continuous use
Warmup time	15 min
Operating temperature	-10–50 °C [14–122 °F]
Charging temperature (battery)	0–50 °C [32–122 °F]
Storage temperature	-20–50 °C [-4–122 °F]
Relative humidity	10–95% non-condensing
Number of precision levels	2 pcs Horizontal
Precision level range	± 10 mm/m [± 10 mils/inch]
Precision level accuracy	± 0.02 mm/m ±1% [± 0.02 mils/inch ±1%]
Precision level sensitivity	0.001 mm/m [0.001 mils/inch]
Laser beam straightness	± 0.01 mm [± 0.4 mils]
Laser plane flatness	± 0.01 mm/m [± 0.01 mils/inch]
Squareness between laser beams	± 0.01 mm/m [± 0.01 mils/inch]
Laser head fine turning	1:132 gear ratio
Environmental protection	IP 55. Designed for outdoor use (pollution degree 4)
TFT display	240x240 pixels, RGB color
Housing material	Anodized aluminium + PC/ABS + TPU
Dimensions	WxHxD: 147x126x152 mm [5.79x4.97x5.98"]
Weight	2065 g [72.86 oz]
Altitude	0-3000 m during storage/transport 0-2000 m during operation

Switch battery

If batteries need to be switched, contact your local service center.

Only use batteries provided by Easy-Laser.

Labels with laser safety precautions

Label on the back of XT23

Label on the XT23 laser head

D22 TECHNICAL DATA

Part. no 12-0022

Laser transmitter D22 can be used to measure flatness, straightness, squareness and parallelism. The laser beam can sweep 360° with a measurement distance of up to 40 metres [130'] in radius. The laser beam can be angled 90° to the sweep, within 0.01 mm/m [2 arc sec.].

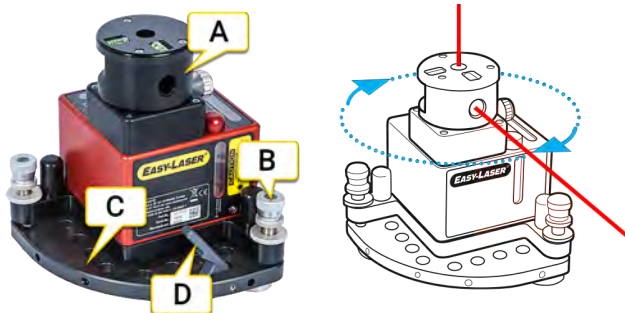

- A. Rotatable head with angular prism.
- B. Tilting screw.
- C. Tilting table.
- D. The release lever has to be removed before the D22 can be mounted on a tripod.

NOTE! This device is a part of a measuring system and the intended use for the device is industrial measuring together with other Easy-Laser products, according to the instructions in this manual. The device is intended for professional use only. Neither Easy-Laser nor its authorized distributors shall be liable for damage to machinery or systems caused by improper use of this device.

NOTE! The tilting screws on the levelling table have to be operated carefully and according to instructions. See "Laser transmitter D22" on page 271

NOTE! If not using the laser for a long period of time, remove the battery.

SERVICE AND SUPPORT

If the unit is damaged it has to be sent for repair. Contact your local service center as found on www.easylaser.com.

Type of laser	Diode laser
Laser wavelength	630–680 nm, visible red light
Laser safety class	Class 2
Laser output power	<0.6 mW
Beam diameter	6 mm [1/4"] at aperture
Working area, range	40-metre radius [130']
Type of battery	1 x R14 (C) 1.5V, replaceable by user. Professional alkaline batteries recommended.
Operating temperature	0–50° C
Operating time/battery	appro. 24 hours
Levelling range	± 30 mm/m [± 1.7°]
3 x spirit vials' scaling	0.02 mm/m
Squareness between laser beams	0.01 mm/m [2 arc sec.]
Flatness of sweep	0.02 mm/m
Fine turning	0.1 mm/m [20 arc sec.]
2 x spirit vials for rotation	5 mm/m

TECHNICAL DATA

Housing material	Aluminium
Dimensions	WxHxD: 139x169x139 mm [5.47"x6.64"x5.47"]
Weight	2650 g [5.8 lbs]
Operating temperature	0–50° C
Altitude	0-2000 m
Designed for outdoor use (pollution degree 4)	

Labels with laser safety precautions

Label on the front of D22



XT24 TECHNICAL DATA

XT24 part. no 12-1371.

Laser transmitter XT24 for measuring straightness.



NOTE! This device is a part of a measuring system and the intended use for the device is industrial measuring together with other Easy-Laser products, according to the instructions in this manual. The device is intended for professional use only. Neither Easy-Laser nor its authorized distributors shall be liable for damage to machinery or

SERVICE AND SUPPORT

If the unit is damaged it has to be sent for repair. Contact your local service center as found on www.easylaser.com.

Type of laser	Fiber-coupled diode laser
Laser wavelength	630–680 nm, visible red light
Laser safety class	Class 2
Laser output power	<0.6 mW
Beam diameter	6 mm [1/4"] at aperture, 13 mm [0.51"] at 40 m [132']
Working range	40 m [132']
Connections	Charger
Type of battery	Heavy duty Li-Ion chargeable
Operating time	Up to 24 hours continuous use
Warmup time	15 min
Operating temperature	-10–50 °C [14–122 °F]
Storage temperature	-20–50 °C [-4–122 °F]
Relative humidity	10–95% non-condensing
Laser beam straightness	±0.001 mm (after best fit operation) [±0.040 mils] (after best fit operation)
Laser adjustment on hub	Angle: 2 ways ±1.3° (± 23 mm/m) Offset: ±5 mm in two axes
Environmental protection	IP66/67, designed for outdoor use (pollution degree 4)
Housing material	Anodized aluminium
Dimensions	WxHxD: 69x49.5x107 mm [2.7x2.0x4.2"]
Weight	520 g [1.19 oz]
Altitude	0-3000 m during storage/transport 0-2000 m during operation

XT7 TECHNICAL DATA

Part. no 12-xxxx.

Laser detector XT7 can be used to measure Straightness, Bore Center and Values ...

- A.  On/Off.
- A. Bluetooth connection.
- B. Battery and charge indicator.
- C. Detector PSD.

NOTE! This device is a part of a measuring system and the intended use for the device is industrial measuring together with other Easy-Laser products, according to the instructions in this manual. The device is intended for professional use only. Neither Easy-Laser nor its authorized distributors shall be liable for damage to machinery or systems caused by improper use of this device.

SERVICE AND SUPPORT

If the unit is damaged it has to be sent for repair. Contact your local service center as found on www.easylaser.com.

Communication	BT Wireless technology
Connections	Charger
Type of battery	Li-Ion chargeable
Operating time	Up to 15 hours continuous use
Operating temperature	-10–50 °C [14–122 °F]
Charging temperature (battery)	0–40 °C [32–104 °F]
Storage temperature	-20–50 °C [-4–122 °F]
Relative humidity	10–95% non condensing
Housing materials	Aluminum, PC/ABS
Dimensions	99.9 x Ø44 mm [3.933" x Ø1.732"]
Detector size	20x20 mm, 2 axis
Minimum measurable diameter	80 mm [3.15"] (se NOTE! below)
PSD accuracy at room temperature	±0.001 mm ±1%
PSD resolution	0.001 mm
PSD linearization	Scale factor, offset and nonlinear compensation
PSD parallelism compensation	Electrical
Inclinometer accuracy	±1°
Inclinometer resolution	0.1°
Inclinometer range	360°
Inclinometer linearization	7 parameters; model using A,B,C,D,E,F and offset.
Weight	194 g [6.8 oz]
Altitude	0-3000 m during storage/transport 0-2000 m during operation

Switch batteries

If batteries need to be switched, contact your local service center.

Only use batteries provided by Easy-Laser.

XT9 TECHNICAL DATA

Part. no 12-1350.

Laser detector XT9 can be used to measure Straightness, Bore Center and Values.



- A.  On/Off.
- B. Bluetooth connection.
- C. Battery and charge indicator.
- D. Detector PSD.

NOTE! This device is a part of a measuring system and the intended use for the device is industrial measuring together with other Easy-Laser products, according to the instructions in this manual. The device is intended for professional use only. Neither Easy-Laser nor its authorized distri

SERVICE AND SUPPORT

If the unit is damaged it has to be sent for repair. Contact your local service center as found on www.easylaser.com.

Communication	BT Wireless technology
Connections	Charger
Type of battery	Li-Ion chargeable
Operating time	Up to 15 hours continuous use
Operating temperature	-10–50 °C [14–122 °F]
Charging temperature (battery)	0–40 °C [32–104 °F]
Storage temperature	-20–50 °C [-4–122 °F]
Relative humidity	10–95% non condensing
Housing materials	Aluminum, PC/ABS
Dimensions	99.9 x Ø44 mm [3.933" x Ø1.732"]
Detector size	20x20 mm, 2 axis
Minimum measurable diameter	80 mm [3.15"] (se NOTE! below)
PSD accuracy at room temperature	±0.001 mm ±1%
PSD resolution	0.001 mm
PSD linearization	Scale factor, offset and nonlinear compensation
PSD parallelism compensation	Electrical
Inclinometer accuracy	±1°

Inclinometer resolution	0.1°
Inclinometer range	360°
Inclinometer linearization	7 parameters; model using A,B,C,D,E,F and offset.
Weight	194 g [6.8 oz]
Altitude	0-3000 m during storage/transport
	0-2000 m during operation

NOTE! When using the XT9 detector in long tubes with small diameters (<80 mm, 3.15") wireless communication can be affected. Always consult your distributor before purchase. For normal bore alignment applications there is no problem.

Switch batteries

If batteries need to be switched, contact your local service center.

Only use batteries provided by Easy-Laser.

XT290 TECHNICAL DATA

Part. no 12-1241

Digital Precision Level XT290 for setting-up and aligning most types of machine, for example levelling machine tables, rolls, bases etc. Other areas of use include straightness, flatness and parallelism.



NOTE! This device is a part of a measuring system and the intended use for the device is industrial measuring together with other Easy-Laser products, according to the instructions in this manual. The device is intended for professional use only. Neither Easy-Laser nor its authorized distributors shall be liable for damage to machinery or systems caused by improper use of this device.

SERVICE AND SUPPORT

If the unit is damaged it has to be sent for repair. Contact your local service center as found on www.easylaser.com.

Displayed resolution	0.1 / 0.01 / 0.001 mm/m [mils/inch]
	0.001 / 0.0001 / 0.00001 inch/foot
	10 / 1 / 0.1 arcsec
	0.01 / 0.001 / 0.0001 degrees
Precision level, measuring range	± 20 mm/m [mils/inch] (pitch)
Precision level, accuracy	±0.02 mm/m ±1% [±0.02 mils/inch ±1%]
Precision level, sensitivity	0.001 mm/m [0.001 mils/inch]
Inclinometer, measuring range	±180° (pitch and roll)
Inclinometer, accuracy	±0.2° (within range ±5°), ±1° (within range ±180°)
Type of display	TFT 240x240 pixels, RGB color
Communication	BT wireless technology, 20 m [65'] range
Environmental protection	IP Class 66/67
Warning sensors	Temperature change and vibration
Operating temperature	-10–50 °C [14–122 °F]
Storage temperature	-20–50 °C [-4–122 °F]
Relative humidity	10–95%
Operating time	Up to 20 hours continuously
Charging temperature	0 to +40 °C [32 to 104 °F] (temperature inside the unit)
Internal battery	Li-Ion chargeable [3.7 V, 7.4 Wh, 2000 mAh]
Material	Hardened, polished and corrosion resistant steel, PC/ABS plastic
Dimensions	WxHxD: 149.0x37.3x47.1 mm [5.87x1.47x1.85"]
Weight	548 g [19.3 oz]
Altitude	0-2000m
Designed for outdoor use (pollution degree 4)	

Switch battery

If batteries need to be switched, contact your local service center.

Only use batteries provided by Easy-Laser.

XT440 SHAFT

System Easy-Laser® XT440 Shaft, Part No. 12-0966

With XT440 you can carry out the following:

- Align the machine
- Check soft foot
- Document and share the results



Easy-Laser® XT440 Shaft system (12-0966) includes:

1	Measuring unit XT40-M
1	Measuring unit XT40-S
2	Shaft brackets with chains and rods
4	Rods 60 mm [2.36"]
1	Measuring tape 3 m [9.8']
1	Hexagon wrench set
1	Charger (100–240 V AC)
1	DC split cable for charging
1	DC to USB adapter, for charging
1	Shoulder strap for display unit
1	Quick reference manual
1	Cleaning cloth for optics
1	USB memory with manuals
1	Documentation folder
1	Carrying case Medium Weight: 6.0 kg [13.3 lbs], Dimension WxHxD: 460x350x175 mm [18.1"x13.8"x6.9"]

Display Unit XT12 (12-1291/12-1292) is sold separately and is not included in the XT440 Shaft system (12-0966).

XT550 SHAFT

System Easy-Laser® XT550 Ex/ATEX Shaft, Part No. 12-1031

XT550 is designed for use in potentially explosive (EX) atmospheres. Specific EX certifications apply; see the technical data. Please read and follow the safety instructions below. The EX rating is valid for the XT50 measuring units only (part number 12-1026 & 12-1027). Brackets, fixturing equipment, case, and other accessories are not subject to any EX classification, and must be assessed by the user before use in EX environment. Easy-Laser does not take responsibility for the EX safety of accessories. The ECOM Tab-Ex® Display unit has separate EX certification; see the technical data below. **Please read and follow the safety instructions described below.**

With XT550 you can carry out the following:

- Align the machine
- Check base twist
- Check bearing play
- Check soft foot
- Document and share the results



Easy-Laser® XT550 Shaft system (12-1031) includes:

1	Measuring unit XT50-M
1	Measuring unit XT50-S
2	Shaft brackets with chains and rods
4	Rods 60 mm [2.36"]
2	Rods 120 mm [4.72"]
2	Extension chains 900 mm [35.4"]
1	Measuring tape 3 m [9.8"]
1	Rod tool
1	Charger (100–240 V AC)
1	DC split cable for charging. Length 1 m [39.4"]
1	USB cable
1	Quick reference manual
1	Cleaning cloth for optics
1	USB memory with manuals
1	Carrying case (with conductive plastic and foam)

Display Unit ecom TabEx 03 (12-1484) is sold separately and is not included in the XT550 Shaft system (12-1031).

Display unit ecom Tab-Ex® 03 DZ1. (For full technical specification, see www.ecom-ex.com)

Type of display/size	TFT 8" color screen (1920 x 1200 pixels)
----------------------	--

TECHNICAL DATA

Operating system	Android™ 15 or higher
Operating time	Up to 14 h continuously
Communication	Bluetooth® 5.3. WLAN 802.11 a/b/g (2.4 GHz), WiFi 4,5,6 (2.4 GHz + 5 GHz)
Camera	13 MP (rear), 5 MP (front)
Operating temperature	-20 to +55 °C [-4 to +131 °F]
Dimensions	WxHxD: 161.5 mm x 262.75 mm x 25.75 mm [6.4x10.1x1.3"]
Weight	1100 g [2.43 lbs] Approximately
ATEX Ex classification	Ⓔ II 2G Ex db ia IIC T6 Gb, (EX) II 2D Ex tb ia IIIC T80°C Db
Ex certificate number	EPS 24 ATEX 1 288 X, IECEx EPS 24.0082X
Environmental protection	IP68 according to EN/IEC 60529, MIL-STD-810H

For technical data regarding measuring units XT50. See "XT50 Technical data " on page 284.



When there is no network, use USB C cable to transfer measurement values from ECOM Tab-Ex to your computer, see picture above. To read in Explorer: This computer\Easy Laser (SM T360)\Tablet\Android\data\com.easy-laser.xt\files\Measurements.

NOTE! Never charge the unit in intrinsic safety zone and only use the included Easy-Laser charger.



Earlier ecom display unit versions:

Display unit ecom Tab-Ex® 01 DZ1. (For full technical specification, see www.ecom-ex.com)

Type of display/size	TFT 8" color screen
Operating system	Android™ 5.1.1
Operating time	Up to 11 h continuously
Communication	BT LE4.0 Wireless technology, Wi-Fi
Camera	3 MP with flash (rear), 1.3 MP (front)
Operating temperature	-20°C ... +50°C
Dimensions	WxHxD: 162.1x256.0x33.3 mm [6.4x10.1x1.3"]
Weight	1250 g [2.76 lbs]
ATEX classification	Ⓔ II 2G Ex db ia op is IIC T5 Gb Ⓔ II 2D Ex tb IIIC T100°C Db Ta = -20°C to +50°C

IECEX	Ex db ia op is IIC T5 Gb Ex tb IIIC T100°C Db Ta = -20°C to +50°C
Ex certificate number	Sira 15ATEX1205X, IECEX SIR 15.0075X

Display unit ecom Tab-Ex® 02 DZ1. (For full technical specification, see www.ecom-ex.com)

Type of display/size	TFT 8" color screen
Operating system	Android™ Oreo 8.1 or 9
Operating time	Up to 11 h continuously
Communication	BT LE4.2 Wireless technology, Wi-Fi
Camera	8 MP with flash (rear), 5 MP (front)
Operating temperature	-20°C ... +50°C
Dimensions	WxHxD: 162.1x256.0x33.3 mm [6.4x10.1x1.3"]
Weight	1250 g [2.76 lbs]
ATEX classification	 II 2G Ex db ia op is IIC T5 Gb  II 2D Ex tb ia op is IIIC T100°C Db Ta= -20°C to +50°C
IECEX	Ex db ia op is IIC T5 Gb Ex tb ia op is IIIC T100°C Db Ta= -20°C to +50°C
Ex certificate number	Sira 19ATEX1017X, IECEX SIR 19.0012X



When there is no network, use mini USB cable to transfer measurement values from ECOM Tab-Ex to your computer, see picture above. To read in Explorer: This computer\Easy Laser (SM T360)\Tablet\Android\data\com.easylaser.xt\files\Measurements.

NOTE! Never charge the unit in intrinsic safety zone and only use the included Easy-Laser charger.

Safety precautions/Warning

- **Do not charge in potentially explosive environment!**
- Always read and follow operation instructions.
- Opening the housing of the units will invalidate the Ex-rating, voids warranty and may result in hazardous light exposure.
- All repairs must be done by Easy-Laser main service center in Sweden.
- Only use the included Easy-Laser charger (12 V).
- The EX rating is valid for the XT50 measuring units only (part number 12-1026 & 12-1027). Brackets, fixturing equipment, case, and other accessories are not subject to any EX classification, and must be assessed by the user before use in EX environment. Easy-Laser does not take responsibility for the EX safety of accessories

Labels with laser safety precautions

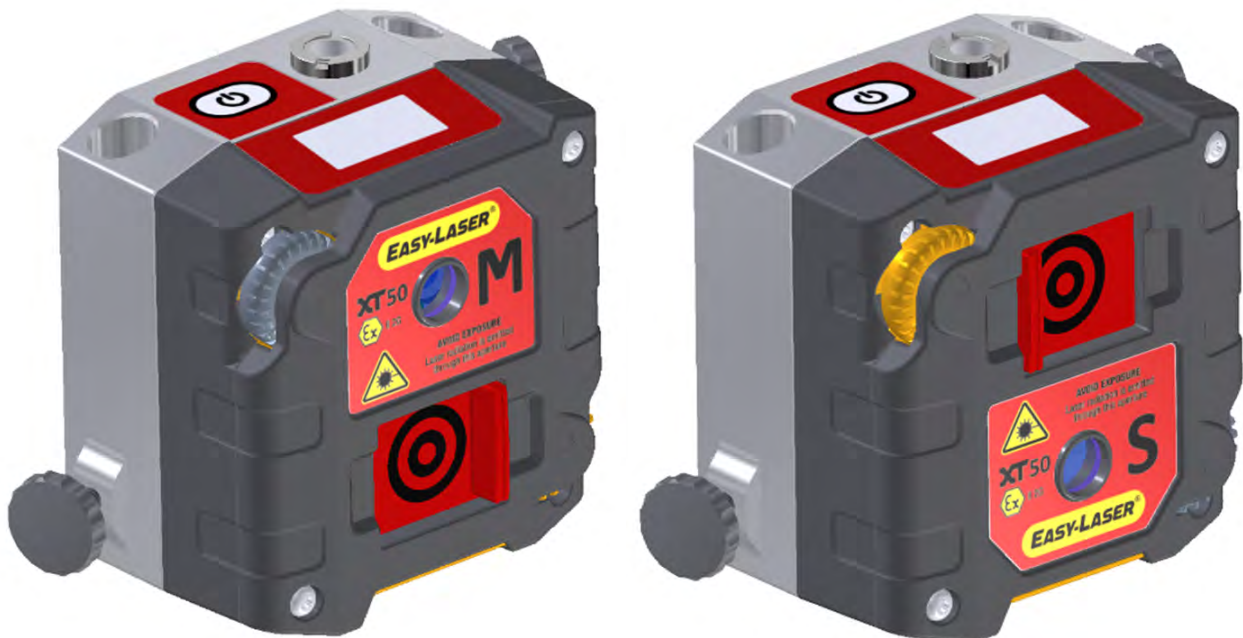



Complies with: 21 CFR 1040.10 and 1040.11 except for conformance with IEC 60825-1 Ed. 3., as described in Laser Notice No. 56, dated May 8, 2019. EN 60825-1:2014+A11:2021.

Contains: FCC ID: Q0QBGM111, IC: 5123A-BGM111
Li-Ion battery 3.7 V 1960 mAh 7.25 Wh

LASER 2

AVERAGE POWER < 0.6 mW. PULSE ENERGY < 20 nJ.
PULSE DURATION 10-17 μs. WAVELENGTH 630-680 nm.

WARNING! DO NOT CHARGE IN POTENTIALLY EXPLOSIVE ENVIRONMENT

Ex II 2G Ex ib op is IIC T4 Gb
II 2D Ex ib op is IIIC T135°C Db
-10°C ≤ Ta ≤ +50°C
Presafe 17 ATEX 10552X, IECEx PRE 17.0049X

Part No. [Redacted] **CE**
Serial No. [Redacted] 0470
Manufactured [Redacted] **IP66/67**

Calibration due: **XT50**

Easy-Laser AB
Alfagatan 6, 431 49 Mölndal, Sweden. www.easylaser.com

XT660 SHAFT

System Easy-Laser® XT660 Shaft, Part No. 12-1058 (Medium case)

With XT660 you can carry out the following:

- Align the machine
- Check base twist
- Check bearing play
- Check soft foot
- Document and share the results



Easy-Laser® XT660 Shaft system (12-1058) includes:

1	Measuring unit XT60-M
1	Measuring unit XT60-S
2	Shaft brackets with chains and rods
4	Rods 60 mm [2.36"]
2	Extension chain 900 mm [35.4"]
1	Measuring tape 3 m [9.8']
1	Hexagon wrench set
1	Charger (100–240 V AC)
1	DC split cable for charging
1	DC to USB adapter, for charging
1	Shoulder strap for display unit
1	Quick reference manual
1	Cleaning cloth for optics
1	USB memory with manuals
1	Documentation folder
1	Carrying case Medium Weight: 6.8 kg [14.9 lbs], Dimension WxHxD: 460x350x175 mm [18.1"x13.8"x6.9"]

Display Unit XT12 (12-1291/12-1292) is sold separately and is not included in the XT660 Shaft system (12-1058).

XT770 SHAFT

System Easy-Laser® XT770, Part No. 12-1096 (Large case).

With XT770 you can carry out the following:

- Align the machine
- Check base twist
- Check bearing play
- Check soft foot
- Measure machine movement over time
- Document and share the results



Easy-Laser® XT770 Shaft system (12-1096) includes:

1	Measuring unit XT70-M
1	Measuring unit XT70-S
2	Shaft brackets with chains and rods
4	Rods 60 mm [2.36"]
2	Magnet base
2	Offset bracket
2	Extension chain 900 mm [35.4"]
1	Measuring tape 3 m [9.8']
1	Hexagon wrench set
1	Charger (100–240 V AC)
1	DC split cable for charging
1	DC to USB adapter, for charging
1	Shoulder strap for display unit
1	Quick reference manual
1	Cleaning cloth for optics
1	USB memory with manuals
1	Documentation folder
1	Carrying case Medium (or Large GEO)

Display Unit XT12 (12-1291/12-1292) is sold separately and is not included in the XT770 Shaft system (12-1096).

System 12-1128 also includes:

1	Laser transmitter XT20
1	Multi bracket for XT laser
1	Magnet base with turnable head (replaces one of the regular magnet bases)
4	Rods 120 mm [4.72"]

TECHNICAL DATA

System 12-1134 also includes:

1	Laser transmitter XT22
1	Multi bracket for XT laser
1	Magnet base with turnable head (replaces one of the regular magnet bases)
4	Rods 120 mm [4.72"]

Weight for 12-1096: 13.0 kg [28.7 lbs]

Weight for 12-1128: 16.0 kg [35.3 lbs]

Weight for 12-1134: 16.2 kg [35.7 lbs]

XT980 SAWMILL

System Easy-Laser® XT980 Sawmill, Part No. 12-1335.

With XT980 you can carry out the following:

- Measuring and adjustment of reducers, counterholds, saw blades and discs
- Use with circular saws or band saws
- Measure absolutely straight for 40 metres
- Document and share the results



Easy-Laser® XT980 Shaft system (12-1335) includes:

1	Laser transmitter XT22
1	Measuring unit XT70-M
2	Electronic target
1	Multi bracket for XT laser
1	Magnet base with turnable head
1	Magnet base
1	Shaft bracket with chain
2	Offset bracket
2	Bracket for electronic target
1	Rotating detector bracket for rods
1	Magnet bracket long, with turnable head
1	Magnet bracket short, with turnable head
1	Bracket (Set square) for index table
1	Index table 90°
2	Set of Rods (4x120 mm) [5.08"]
1	Set of Rods (4x75 mm) [2.95"]
2	Large target with magnets
1	Quick Guide (English)
1	Measuring tape 5 m
1	Documentation folder GEO
1	USB cable
1	Battery charger (100–240 V AC)
1	DC split cable for charging
1	DC to USB adapter
2	Screw clamps
1	Hexagon wrench set

TECHNICAL DATA

1	Toolbox XT GEO
1	Shoulder strap for Display unit
1	Transportation case, with wheels

Weight for 12-1335: 28.0 kg [61.7 lbs]

Display Unit XT12 (12-1291/12-1292) is sold separately and is not included in the XT980 Shaft system (12-1335).

XT190 BTA

Part. no 12-1053

When aligning with the Easy-Laser® BTA you reduce the wear on sheaves/pulleys, belts, bearings and seals as well as reducing vibration.



NOTE! This device is a part of a measuring system and the intended use for the device is industrial measuring together with other Easy-Laser products, according to the instructions in this manual. The device is intended for professional use only. Neither Easy-Laser nor its authorized distributors shall be liable for damage to machinery or systems caused by improper use of this device.

NOTE! If not using the system for a long period of time, remove the battery from the laser transmitter.

NOTE! Clean the units and the windows at the apertures with a dry cotton cloth.

SERVICE AND SUPPORT

If the unit is damaged it has to be sent for repair. Contact your local service center as found on www.easylaser.com.

Laser transmitter

Type of laser	Diode laser
Sheave diameter	> 60 mm [2.4"]
Laser class	Class 2
Laser output power	<0.6 mW (low power mode) < 4.8 mW (high power mode)
Laser wavelength	630–680 nm
Beam angle	>55°
Measurement Accuracy	Offset ± 0.2 mm [± 8 mils], Angle $\pm 0.05^\circ$
Measurement Range	40 mm –3 m [1.6 in –10 ft] (low power mode) 0.5 m –10 m [20 in –33 ft] (high power mode)
Battery type	1xR6 (AA) 1.5 V
Operating time	Up to 12 h continuously
Operating temperature	-10–50°C
Storage temperature	-20–50°C
Housing material	ABS plastics / Hard anodized aluminium
Dimensions	WxHxD: 147x87x31 mm [5.8x3.4x1.2"]
Weight	265 g [9.35 oz]
Altitude	0–2000 m

TECHNICAL DATA

Designed for indoor use (pollution degree 2)

Laser classification

The D92 is classified as laser class 2, for more information See "Safety precautions" on page 331. These products are safe under reasonably foreseeable conditions of operation and are not harmful to the eyes provided that the products are used and maintained in accordance with this User Manual.



A. Laser aperture

Label with safety precautions



Detector

Sheave diameter	> 60 mm [2.4"]
Measurement range	40 mm –3 m [1.6 in –10 ft] (when used with D92 in LOW power mode, or with D90) 0.5 m –10 m [20 in –33 ft] (when used with D92 in HIGH power mode)
Measurement accuracy	Offset: ± 0.1 mm [± 4 mils] Angle: $\pm 0.01^\circ \pm 1\%$
Detector range	Offset: ± 3 mm [± 0.12 "] Angle: $\pm 8^\circ$
Display resolution	Offset: 0.1 mm [0.01"] Angle: 0.01°
Display type	Yellow OLED 96x96 pixels
Communication	Wireless technology
Battery type	Li-Ion
Operating time	Up to 5 hours continuously
Operating temperature	-10–50°C
Storage temperature	-20–50°C
Relative humidity	10–95%
Housing material	ABS plastics / Anodized aluminium
Dimensions	WxHxD: 94x94x37 mm [3.7x3.7x1.5"]
Weight	190 g [6.7 oz]
Altitude	0–2000 m
Designed for indoor use (pollution degree 2)	

Detector battery

Press to see the battery status of the detector. While the battery is charging, there is a green flashing light. The laser transmitter flashes when the battery is low. Change the batteries before you continue to measure.



- Red, flashing once: Battery empty.
- Red, flashing twice: Battery needs charging.
- Green, flashing three times: Good.
- Green, fixed light: Battery full.

Switch battery

If batteries need to be switched, contact your local service center.

Only use batteries provided by Easy-Laser.

XT280 VIB

Part No. 12-1050

Vibration analyser that quickly diagnoses vibration level, unbalance, misalignment and looseness.

NOTE! This device is a part of a measuring system and the intended use for the device is industrial measuring together with other Easy-Laser products, according to the instructions in this manual. The device is intended for professional use only. Neither Easy-Laser nor its authorized distributors shall be liable for damage to machinery or systems caused by improper use of this device.

SERVICE AND SUPPORT

If the unit is damaged it has to be sent for repair. Contact your local service center as found on www.easylaser.com.

Size	200 mm x 60mm x 26mm
Weight	280g
Environmental	
Water, sand and dust	IP67 Waterproof
Operating temperature	0°C to 50°C
Storage temperature	-20°C to 70°C
Power supply	2xR6 (AA) 1.5 V
Battery life	Auto power OFF - typically 20 hours continuous operating time depending on brightness setting.
Frequency range	2 Hz to 1 kHz (ISO) 1 kHz to 10 kHz (BDU)
Max frequency resolution	1.25 Hz @ 800 lines FFT setting Acceleration in g Velocity in mm/s (or inch/s) Bearing noise in BDU (bearing damage units) Displacement (mm, microns, inch)
Displayed Frequency Units	Hertz (Hz), RPM or CPM
Input range	User selectable with accelerometer sensitivity
Dynamic range	96 dB (0.01g resolution)
VA diagnostic bands (RPM = run speed)	Unbalance 1x RPM Alignment 2x RPM Looseness 3x RPM

Optional equipment

Stinger 03-1326 accessory probe (length 100 mm) and Magnet 03-1327.



CHARGERS FOR XT SERIES

Charger used for XT40, XT60, XT70, XT190, XT290, XT11 and XT12

Part no: 03-1256



NOTE! This device is a part of a measuring system and the intended use for the device is industrial measuring together with other Easy-Laser products, according to the instructions in this manual. The device is intended for professional use only. Neither Easy-Laser nor its authorized distributors shall be liable for damage to machinery or systems caused by improper use of this device.

SERVICE AND SUPPORT

If the unit is damaged it has to be sent for repair. Contact your local service center as found on www.easylaser.com.

Model	EA10682N-150
AC Input	100–240 V AC ~2.0 A, 50–60 Hz
DC Output	15.0 V DC 4.0 A, 60.0 W
Efficiency	$\geq 89.0\%$ (avg.) at 115Vac/60Hz or 230Vac/50Hz input voltage and 25%, 50%, 75% or 100% of max output current. $\geq 79.0\%$ at 115Vac/60Hz or 230Vac/50Hz input voltage and 10% of max output current. $\leq 0.15\text{W}$ at no load power consumption, at normal line input.
Power cords available	US, EU, UK and AUS
Humidity	10% to 90% (storage 5% to 90%)
Operating temperature	0–40 °C (storage temperature: -20 °C to +85 °C)
Altitude	0–5000 m
Designed for indoor use only	

Charger used for XT50

Part no: 12-1281



NOTE! This device is a part of a measuring system and the intended use for the device is industrial measuring together with other Easy-Laser products, according to the instructions in this manual. The device is intended for professional use only. Neither Easy-Laser nor its authorized distributors shall be liable for damage to machinery or systems caused by improper use of this device.

SERVICE AND SUPPORT

If the unit is damaged it has to be sent for repair. Contact your local service center as found on www.easylaser.com.

Model	GPE024P-120200-D
AC Input	100–240 V AC ~0,75 A, 50–60 Hz
DC Output	12,0 V DC 2,0 A, 24,0 W
Efficiency	≥86,2% (avg.) at 115Vac/60Hz or 230Vac/50Hz input voltage and 10%, 25%, 50%, 75% or 100% of max output current. ≥76,8% at 115Vac/60Hz or 230Vac/50Hz input voltage and 10% of max output current. ≤0,1W at no load power consumption, at normal line input.
Power cords available	US, EU, UK and AUS
Humidity	8% to 90% (storage 5% to 95%)
Operating temperature	0–40 °C (storage temperature: -25 °C to +70 °C)
Altitude	0–2000 m
Designed for indoor use only	

LEGAL NOTICE

QUALITY CERTIFICATE

Equipment: Easy-Laser® product range

Quality statement

Easy-Laser AB is ISO 9001:2015 certified. Certificate number: 900958.

Easy-Laser AB confirms that our products are produced according to applicable national and international regulations and standards.

Warranty commitment

Easy-Laser AB develops and manufactures the Easy-Laser® product range. The products are manufactured under our stringent quality controls, and each Easy-Laser® system undergoes a Factory Acceptance Test and is visually inspected prior to delivery. If the product is malfunctioning or stops working within three (3) years of purchase, the warranty applies with free repair or replacement of defective parts or products.

Warranty does not apply:

- If the product is handled carelessly or incorrectly.
- If the product is subjected to environment factors that exceed the product specification limits, such as temperature, moisture, shock or high voltages.
- If the product is modified, repaired or dismantled by non approved personnel.

Compensation for any secondary damage caused by an Easy-Laser® product fault does not apply. Easy-Laser AB is not responsible for any transport costs for equipment sent back to Easy-Laser AB for repair.

Lithium Ion battery limited warranty

A Lithium ion battery inevitably loses power during its lifetime, depending on usage temperature and the number of charging cycles. Therefore, internal rechargeable batteries in the Easy-Laser® product range are not included in our general 3-year warranty. A 1-year warranty applies for the battery capacity to stay above 70 % (after 300 charging cycles, the battery should have more than 70 % of its nominal capacity left). A 3-year warranty applies if the battery becomes unusable because of a manufacturing fault or factors that Easy-Laser AB could be expected to have control of, or if the battery displays abnormal degradation of capacity in relation to use.

ECOM Tablet Computer limited warranty

The warranty of ECOM Tablet Computer (part no. 12-1086 / 12-1196 / 12-1327) is one (1) year.

Measurement data

It is the responsibility of the customer to make a backup of all saved data before the product is sent for repair. Resetting of saved measurement data is not covered by the warranty. Easy-Laser AB takes no responsibility for saved data that is damaged or lost during transportation or repair.

Rebecka Tegnander
Quality Manager, Easy-Laser AB

IP CODE AND CLASSIFICATION

How do I read the protection ratings?

The IP protection rating system is a standard defined in international standard IEC 60529. This rating system classifies the degree of protection provided by an electrical equipment enclosure against solid objects (such as dust) and liquids (water, oil, etc.). The degree of protection provided by an enclosure is indicated with a two-digit (IPXX) system as described below:

The first number corresponds to the degree of protection provided against solid objects. The second number corresponds to the degree of protection provided against liquids. The rating IP66 thus corresponds to a product that is completely dust-tight and protected against powerful water jetting.

Note: if the criterion has not been tested for, the number will be replaced by the letter "X" (for example, the rating IPX6 indicates that the enclosure was not tested for protection against the ingress of solid objects).

Up to and including second characteristic numeral 6, the designation implies compliance also with the requirements for all lower characteristic numerals. Equipment with an IP65 certification is thus authorized for applications requiring an IP55 or IP64 certification.

IEC 60529 standard (article 6) considers that an enclosure designated with second characteristic numeral 7 or 8 is unsuitable for exposure to water jets (designated by second characteristic numeral 5 or 6) unless it is dual coded (ex: IPX5/IPX7 or IPX6/IPX7). Hence, IP classification IP66/67 found on some Easy-Laser units means that they are dust-tight (first characteristic numeral) and protected against powerful jetting and protected against temporary immersion up to 1 m for 30 min (second characteristic numerals 6 and 7). Ingress of water in harmful quantity shall not be possible.

The first number indicates the degree of protection against solid objects	The second number indicates the degree of protection against liquids
X: Not measured	X: Not measured
0: Non-protected	0: Non-protected
1 = protected against ingress of solid foreign objects ≥ 50 mm in diameter	1 = Protected against vertical dripping
2 = protected against ingress of solid foreign objects ≥ 12.5 mm in diameter	2 = Protected against dripping (15% tilt)
3 = protected against ingress of solid foreign objects ≥ 2.5 mm in diameter	3 = Protected against spraying (60% tilt)
4 = protected against ingress of solid foreign objects ≥ 1 mm in diameter	4 = Protected against splashing
5 = protected against dust (limited entry, no harmful deposits)	5 = Protected against jetting
6 = dust-tight	6 = Protected against powerful jetting
	7 = Protected against temporary immersion (up to 1 meter for 30 minutes) - ingress of water in harmful quantity shall not be possible.
	8 = Protected against continuous immersion (depth of more than 1 meter for period of time specified by the manufacturer). The equipment is suitable for continuous immersion in water. However, this can mean that water can enter but only in such a manner that it produces no harmful effects.

SAFETY PRECAUTIONS

NOTE! Opening the laser units can result in hazardous radiation, and will invalidate the manufacturer warranty.

If starting the machine to be measured would result in injuries, the possibility to unintentionally start it must be disabled before mounting the equipment, for example by locking the switch in the off position or removing the fuses. These safety precautions should remain in place until the measurement equipment has been removed from the machine.

These products are intended for professional use, measurement according to the manual, performed by specially trained personnel.

If these products are not used as intended, the protection provided by the devices may be impaired.

NOTE! The system must not be used in explosive risk areas.

Laser safety

Easy-Laser® is a laser instrument in laser class 2 which requires the following safety precautions:

- Never stare directly into the laser beam
- Never aim the laser beam at anyone's eyes

This User Manual contains information about laser safety according to standard EN 60825-1:2014+A11:2021 and 21 CFR 1040.10 and 1040.11 except for conformance with IEC 60825-1 Ed. 3., as described in Laser Notice No. 56, dated May 8, 2019.

The information enables the person responsible for the product and the person who actually uses the equipment, to anticipate and avoid operational hazards.

According to EN 60825-1:2014+A11:2021 and 21 CFR 1040.10 and 1040.11, products classified as laser class 2 do **not** require:

- laser safety officer involvement
- protective clothes and eyewear
- special warning signs in the laser working area

if used and operated as defined in this User Manual due to the low eye hazard level.

National laws and local regulations could impose more stringent instructions for the safe use of lasers.

It may be hazardous to look directly into the beam, in particular for deliberate exposure. The beam may cause strong temporary blindness, especially under low ambient light conditions. However, the risk of injury for Class 2 laser products is very low because:

- The exposure limits for the laser class include a safety margin, which means that the limits are substantially below those levels of radiation that are known to cause damage.
- The natural reflex of the eye to avoid strong light limits unintentional exposure to a very short time (0.25 s).

The following warning symbols are used to indicate Class 2 laser products.



The following warning symbol indicates the aperture where laser light is emitted. Avoid exposure to the eyes.



LEGAL NOTICE

If the laser beam hits the detector but the system is unable to measure, it could be caused by a laser malfunction and the laser light may be above safe power level.

If this is the case, don't use the system until you have been in contact with your local service center.

Travelling with your measurement system

The system includes lithium-batteries. For more information see the product specifications in Technical data. When travelling by airplane with your measurement system we strongly recommend that you check which rules that apply for each airline company.

Specifications for built-in rechargeable batteries

Easy-Laser Part No.	Type	Nominal Voltage	Nominal Capacity	Energy	Included in Part No.
12-1301 (2 x 12-0953)	Li-Ion	7.4 V	2000 mAh	2 x 7.4 Wh	12-1272, 12-1273
12-1100	Li-Ion	3.65 V	11400 mAh	41.61 Wh	12-0418, 12-0700, 12-0748, 12-1062, 12-1077
03-0765	Li-Ion	3.7 V	660 mAh	2.5 Wh	12-0433, 12-0434, 12-0509, 12-0688, 12-0702, 12-0738, 12-0752, 12-0758, 12-0759, 12-0789, 12-0790, 12-0799, 12-0824, 12-1067, 12-1068, 12-1069, 12-0846
03-0971	Li-Ion	3.6 V	2600 mAh	9.36 Wh	12-0617, 12-0618, 12-0823, 12-0845
03-1052	Li-Ion	3.7 V	330 mAh	1.22 Wh	12-0746, 12-0747, 12-0776, 12-0777, 12-0791, 12-1054
12-0953	Li-Ion	3.7 V	2000 mAh	7.4 Wh	12-0943, 12-0944, 12-1028, 12-1029, 12-1045, 12-1046, 12-1241
12-1307	Li-Ion	3.7 V	1960 mAh	7.25 Wh	12-1026, 12-1027
N/A	Li-Ion	3.8 V	4450 mAh	16.91 Wh	12-1086, 12-1196
12-1099	Li-Ion	7.3 V	5700 mAh	41.64 Wh	12-0961 (2 pcs)
03-1702	Li-Ion	3.6 V	18900 mAh	68.04 Wh	12-1291, 12-1292
N/A	Li-Ion	3.85 V	4900 mAh	18.87 Wh	12-1327

SERVICE AND CALIBRATION

Our Service centers will quickly assist you if your measurement system need to be repaired or when it is time for calibration.

Our main Service center is located in Sweden. There are several local Service centers that are certified to carry out limited service and repair. Contact your local Service center first before sending your equipment for service or repair. All Service centers are listed on our web site under Service and Calibration.

Before sending your measuring system to our main Service center, please fill in the online Service and Repair report.

DISPOSAL OF OLD ELECTRICAL AND ELECTRONIC EQUIPMENT

(Applicable throughout the European Union and other European countries with separate collection programs). This symbol, found on product or on its packing, indicates that this product should not be treated as household waste when disposed of. It should be handed over to an applicable collection point for the recycling of electrical and electronic equipment. By ensuring this product is disposed correctly, you will help to prevent potential negative consequences to the environment and human health. For more detailed information about the recycling of this product, please contact your local city office, household waste disposal service or the retail store where you purchased this product.



COPYRIGHT

© Easy-Laser AB 2024

We might change and correct the manual in later issues without further information.

Changes to the Easy-Laser® equipment may also affect the accuracy of the information.

Address

Easy-Laser AB, PO Box 149, SE-431 22 Mölndal, Sweden

Phone: +46 31 708 63 00, E-mail: info@easylaser.com

Web: www.easylaser.com

Disclaimer

©Easy-Laser AB 2024

Easy-Laser AB and our authorized dealers will take no responsibility for damage to machines and plant as a result of the use of Easy-Laser® measurement and alignment systems.

SOFTWARE LICENSES

Third-party Licenses

The MIT License (MIT)

- Json.NET Copyright (c) 2007 James Newton-King, <https://www.newtonsoft.com/json>
- Azure.Monitor.OpenTelemetry.Exporter Copyright (c) 2015 Microsoft, <https://github.com/Azure/azure-sdk-for-net/tree/main/sdk/monitor/Azure.Monitor.OpenTelemetry.Exporter>
- YAXLib Copyright (c) 2009 - 2013 Sina Iravanian (sina@sinairv.com), <https://github.com/YAXLib/YAXLib>
- ResgateIO.Client Copyright (c) 2021 Samuel Jirénius, <https://resgate.io/>
- OxyPlot Copyright (c) 2014 OxyPlot contributors, <https://oxyplot.github.io/>
- Zenject Copyright (c) 2010-2015 Modest Tree Media, <http://www.modesttree.com>

Permission is hereby granted, free of charge, to any person obtaining a copy of this software and associated documentation files (the "Software"), to deal in the Software without restriction, including without limitation the rights to use, copy, modify, merge, publish, distribute, sublicense, and/or sell copies of the Software, and to permit persons to whom the Software is furnished to do so, subject to the following conditions:

The above copyright notice and this permission notice shall be included in all copies or substantial portions of the Software.

THE SOFTWARE IS PROVIDED "AS IS", WITHOUT WARRANTY OF ANY KIND, EXPRESS OR IMPLIED, INCLUDING BUT NOT LIMITED TO THE WARRANTIES OF MERCHANTABILITY, FITNESS FOR A PARTICULAR PURPOSE AND NONINFRINGEMENT. IN NO EVENT SHALL THE AUTHORS OR COPYRIGHT HOLDERS BE LIABLE FOR ANY CLAIM, DAMAGES OR OTHER LIABILITY, WHETHER IN AN ACTION OF CONTRACT, TORT OR OTHERWISE, ARISING FROM, OUT OF OR IN CONNECTION WITH THE SOFTWARE OR THE USE OR OTHER DEALINGS IN THE SOFTWARE.

BSD 3-Clause "New" or "Revised" License

- NLog Copyright (c) 2004-2024 Jaroslaw Kowalski <jaak@jkwalski.net>, Kim Christensen, Julian Verdurmen, <https://nlog-project.org/>

Redistribution and use in source and binary forms, with or without modification, are permitted provided that the following conditions are met:

1. Redistributions of source code must retain the above copyright notice, this list of conditions and the following disclaimer.
2. Redistributions in binary form must reproduce the above copyright notice, this list of conditions and the following disclaimer in the documentation and/or other materials provided with the distribution.
3. Neither the name of the copyright holder nor the names of its contributors may be used to endorse or promote products derived from this software without specific prior written permission.

THIS SOFTWARE IS PROVIDED BY THE COPYRIGHT HOLDERS AND CONTRIBUTORS "AS IS" AND ANY EXPRESS OR IMPLIED WARRANTIES, INCLUDING, BUT NOT LIMITED TO, THE IMPLIED WARRANTIES OF MERCHANTABILITY AND FITNESS FOR A PARTICULAR PURPOSE ARE DISCLAIMED. IN NO EVENT SHALL THE COPYRIGHT HOLDER OR CONTRIBUTORS BE LIABLE FOR ANY DIRECT, INDIRECT, INCIDENTAL, SPECIAL, EXEMPLARY, OR CONSEQUENTIAL DAMAGES (INCLUDING, BUT NOT LIMITED TO, PROCUREMENT OF SUBSTITUTE GOODS OR SERVICES; LOSS OF USE, DATA, OR PROFITS; OR BUSINESS INTERRUPTION) HOWEVER CAUSED AND ON ANY THEORY OF LIABILITY, WHETHER IN CONTRACT, STRICT LIABILITY, OR TORT (INCLUDING NEGLIGENCE OR OTHERWISE) ARISING IN ANY WAY OUT OF THE USE OF THIS SOFTWARE, EVEN IF ADVISED OF THE POSSIBILITY OF SUCH DAMAGE.

Apache License, Version 2.0

- Appccelerate.StateMachine Copyright (c) 2008-2019 Appccelerate, <https://appccelerate.github.io/>

- PDFium Copyright 2014 The PDFium Authors, <https://pdfium.googlesource.com/pdfium/>

- CsvHelper Copyright 2015 Josh Close, <https://joshclose.github.io/CsvHelper/>

- ZXing.Net <https://github.com/micjahn/ZXing.Net>

- NPOI, <https://npoi.codeplex.com>

Licensed under the Apache License, Version 2.0 (the "License");

you may not use this file except in compliance with the License.

You may obtain a copy of the License at

<http://www.apache.org/licenses/LICENSE-2.0>

Unless required by applicable law or agreed to in writing, software

distributed under the License is distributed on an "AS IS" BASIS,

WITHOUT WARRANTIES OR CONDITIONS OF ANY KIND, either express or implied.

See the License for the specific language governing permissions and

limitations under the License.

BSD 2-Clause like (altered) license

- Reorderable List GUI for Unity - Copyright (c) 2013, Rotorz Limited.

Copyright (c) 2013, Rotorz Limited

All rights reserved.

Redistribution and use in source and binary forms, with or without

modification, are permitted provided that the following conditions are met:

1. Redistributions of source code must retain the above copyright notice, this list of conditions and the following disclaimer.

2. Redistributions in binary form must reproduce the above copyright notice, this list of conditions and the following disclaimer in the documentation and/or other materials provided with the distribution.

THIS SOFTWARE IS PROVIDED BY THE COPYRIGHT HOLDERS AND CONTRIBUTORS "AS IS" AND

ANY EXPRESS OR IMPLIED WARRANTIES, INCLUDING, BUT NOT LIMITED TO, THE IMPLIED

WARRANTIES OF MERCHANTABILITY AND FITNESS FOR A PARTICULAR PURPOSE ARE

DISCLAIMED. IN NO EVENT SHALL THE COPYRIGHT OWNER OR CONTRIBUTORS BE LIABLE FOR

ANY DIRECT, INDIRECT, INCIDENTAL, SPECIAL, EXEMPLARY, OR CONSEQUENTIAL DAMAGES

(INCLUDING, BUT NOT LIMITED TO, PROCUREMENT OF SUBSTITUTE GOODS OR SERVICES;

LOSS OF USE, DATA, OR PROFITS; OR BUSINESS INTERRUPTION) HOWEVER CAUSED AND

ON ANY THEORY OF LIABILITY, WHETHER IN CONTRACT, STRICT LIABILITY, OR TORT

(INCLUDING NEGLIGENCE OR OTHERWISE) ARISING IN ANY WAY OUT OF THE USE OF THIS

SOFTWARE, EVEN IF ADVISED OF THE POSSIBILITY OF SUCH DAMAGE.

The views and conclusions contained in the software and documentation are those

of the authors and should not be interpreted as representing official policies,

either expressed or implied, of the FreeBSD Project.

LEGAL NOTICE

ChaCha20-csharp, licensed to Scott Bennet

Permission to use, copy, modify, and distribute this software for any purpose with or without fee is hereby granted, provided that the above copyright notice and this permission notice appear in all copies.

THE SOFTWARE IS PROVIDED "AS IS" AND THE AUTHOR DISCLAIMS ALL WARRANTIES WITH REGARD TO THIS SOFTWARE INCLUDING ALL IMPLIED WARRANTIES OF MERCHANTABILITY AND FITNESS. IN NO EVENT SHALL THE AUTHOR BE LIABLE FOR ANY SPECIAL, DIRECT, INDIRECT, OR CONSEQUENTIAL DAMAGES OR ANY DAMAGES WHATSOEVER RESULTING FROM LOSS OF USE, DATA OR PROFITS, WHETHER IN AN ACTION OF CONTRACT, NEGLIGENCE OR OTHER TORTIOUS ACTION, ARISING OUT OF OR IN CONNECTION WITH THE USE OR PERFORMANCE OF THIS SOFTWARE.

GPL written offer

To whom it may concern,

This product contains software whose rightholders license it under the terms of the GNU General Public License, version 2 (GPLv2), version 3 (GPLv3). If you want to receive the complete corresponding source code we will provide you and any third party with the source code of the software licensed under an open source software license if you send us a written request by mail or email to the following addresses:

E-mail

Easy-Laser support: info@easylaser.com

Postal

Easy-Laser AB

Alfagatan 6

Möln dal, SE-431 49

Sweden

FCC/IC WARNING

FEDERAL COMMUNICATIONS COMMISSION INTERFERENCE STATEMENT

This equipment has been tested and found to comply with the limits for a Class B digital device, pursuant to part 15 of the FCC Rules. These limits are designed to provide reasonable protection against harmful interference in a residential installation. This equipment generates, uses and can radiate radio frequency energy and, if not installed and used in accordance with the instructions, may cause harmful interference to radio communications. However, there is no guarantee that interference will not occur in a particular installation. If this equipment does cause harmful interference to radio or television reception, which can be determined by turning the equipment off and on, the user is encouraged to try to correct the interference by one or more of the following measures:

- Reorient or relocate the receiving antenna.
- Increase the separation between the equipment and receiver.
- Connect the equipment into an outlet on a circuit different from that to which the receiver is connected.
- Consult the dealer or an experienced radio/ TV technician for help.

CAUTION:

Any changes or modifications not expressly approved by the grantee of this device could void the user's authority to operate the equipment.

This device complies with Part 15 of the FCC Rules. Operation is subject to the following two conditions: (1) this device may not cause harmful interference, and (2) this device must accept any interference received, including interference that may cause undesired operation.

RF Exposure Information (SAR)

This device meets the government's requirements for exposure to radio waves. This device is designed and manufactured not to exceed the emission limits for exposure to radio frequency (RF) energy set by the Federal Communications Commission of the U.S. Government.

The exposure standard employs a unit of measurement known as the Specific Absorption Rate, or SAR. The SAR limit set by the FCC is 1.6 W/kg. Tests for SAR are conducted using standard operating positions accepted by the FCC with the EUT transmitting at the specified power level in different channels.

The FCC has granted an Equipment Authorization for this device with all reported SAR levels evaluated as in compliance with the FCC RF exposure guidelines. SAR information on this device is on file with the FCC and can be found under the Display Grant section of www.fcc.gov after searching on FCC ID: 2A887-XT12

To ensure that RF exposure levels remain at or below the tested levels, use a belt-clip, holster, or similar accessory that maintains a minimum separation distance of 5mm between your body and the device.

Canada, Industry Canada (IC) Notices

This device contains licence-exempt transmitter(s)/receiver(s) that comply with Innovation, Science and Economic Development Canada's licence-exempt RSS(s). Operation is subject to the following two conditions:

- (1) This device may not cause interference.
- (2) This device must accept any interference, including interference that may cause undesired operation of the device.

Canada, avis d'Industry Canada (IC)

L'émetteur/récepteur exempt de licence contenu dans le présent appareil est conforme aux CNR d'Innovation, Sciences et Développement économique Canada applicables aux appareils radio exempts de licence. L'exploitation est autorisée aux deux conditions suivantes :

1. L'appareil ne doit pas produire de brouillage;

LEGAL NOTICE

2. L'appareil doit accepter tout brouillage radioélectrique subi, même si le brouillage est susceptible d'en compromettre le fonctionnement.

Caution

I. the device for operation in the band 5150–5250 MHz is only for indoor use to reduce the potential for harmful interference to co-channel mobile satellite systems;⁴

II. for devices with detachable antenna(s), the maximum antenna gain permitted for devices in the bands 5250-5350 MHz and 5470-5725 MHz shall be such that the equipment still complies with the e.i.r.p. limit;

III. for devices with detachable antenna(s), the maximum antenna gain permitted for devices in the band 5725-5850 MHz shall be such that the equipment still complies with the e.i.r.p. limits as appropriate; and

IV. where applicable, antenna type(s), antenna models(s), and worst-case tilt angle(s) necessary to remain compliant with the e.i.r.p. elevation mask requirement set forth in section 6.2.2.3 shall be clearly indicated.

I. les dispositifs fonctionnant dans la bande de 5 150 à 5 250 MHz sont réservés uniquement pour une utilisation à l'intérieur afin de réduire les risques de brouillage préjudiciable aux systèmes de satellites mobiles utilisant les mêmes canaux;

II. pour les dispositifs munis d'antennes amovibles, le gain maximal d'antenne permis pour les dispositifs utilisant les bandes de 5 250 à 5 350 MHz et de 5 470 à 5 725 MHz doit être conforme à la limite de la p.i.r.e.;

III. pour les dispositifs munis d'antennes amovibles, le gain maximal d'antenne permis (pour les dispositifs utilisant la bande de 5 725 à 5 850 MHz) doit être conforme à la limite de la p.i.r.e. spécifiée, selon le cas;

IV. lorsqu'il y a lieu, les types d'antennes (s'il y en a plusieurs), les numéros de modèle de l'antenne et les pires angles d'inclinaison nécessaires pour rester conforme à l'exigence de la p.i.r.e. applicable au masque d'élévation, énoncée à la section 6.2.2.3, doivent être clairement indiqués.

PRIVACY POLICY AND TERMS OF USE

Introduction

Welcome to the XT Alignment app! These terms of use govern your use of our mobile app and explain how we collect, use, and protect information from users.

Purpose of Data Collection

We collect anonymized usage data to enhance user experience and the functionality of our app. This includes information about which features are used, how long they are used, and other relevant usage patterns.

Anonymization of Data

All collected data is strictly anonymized and cannot be directly linked to individual users. Our priority is to protect your privacy and ensure that your user data remains confidential.

Consent

By using our app, you consent to the collection and processing of anonymized usage data as described here. You have the option to change your data collection settings in the app's preferences.

Opt-out Option

We understand that privacy is important to you. If you do not want your usage data to be collected, you have the option to disable or adjust the scope of data collection in the app's settings.

Security

We take necessary measures to protect your data from unauthorized access, loss, or alteration. We use secure methods for data transmission and storage.

Changes to Policy

These terms of use may change over time. We will notify you of significant changes and encourage you to review the updated terms.

Contact Information

If you have any questions or concerns about these terms of use or our privacy practices, please contact us at:

Easy-Laser AB, PO Box 149, SE-431 22 Mölndal, Sweden

Phone: +46 31 708 63 00, E-mail: info@easylaser.com

Web: www.easylaser.com

By using our app, you agree to these terms of use and our privacy practices. Thank you for choosing the XT Alignment app!

See "Data collection" on page 21